



## Film Capacitors

### Metallized Polyester Film Capacitors (MKT)

**Series/Type:** B32559C

**Date:** May 2009

**Compact design (stacked)**
**Typical applications**

- Energy saving lamps

**Climatic**

- Max. operating temperature: 125 °C
- Climatic category (IEC 60068-1): 55/125/56

**Construction**

- Dielectric: polyethylene terephthalate (polyester, PET)
- Stacked-film technology
- Heat shrinkable tube standard types B32559C\*: polyester 100 µm, 125 °C

**Features**

- Very small dimensions
- Self-healing properties
- High pulse strength

**Terminals**

- Lead spacing 5.0 mm
- Crimped wire leads, lead-free tinned, lead length (6 – 1) mm
- Straight wire leads, lead-free tinned, lead length (6 – 1) mm
- Special lead length available on request

**Marking**

Manufacturer's logo, rated capacitance (coded), capacitance tolerance (code letter), rated AC voltage, date of manufacture (coded)

**Delivery mode**

Bulk (untaped)

Taped (Ammo pack or reel)

For notes on taping, refer to chapter "Taping and packing".

**Detail specifications**

Homologated to IEC 60384-2

**Dimensional drawing**

Straight leads

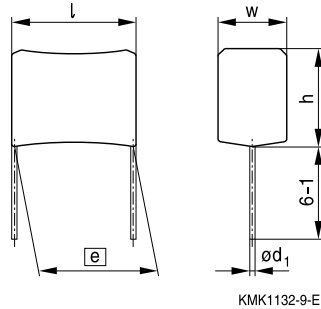

Crimped leads

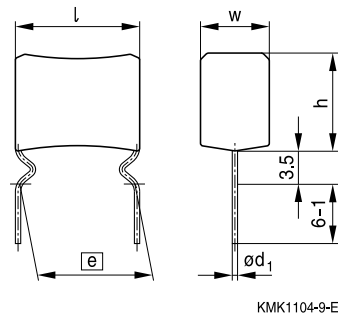

Dimensions in mm

Lead spacing	Lead diameter $d_1$
$e \pm 0.4$	
5.0	0.5

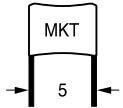
**Overview of available types**

Lead spacing	5.0 mm				
Type	B32559C				
Lead configuration	straight / crimped				
Page	4				
$V_R$ (V DC)	63	100	250	400	630
$V_{RMS}$ (V AC)	40	63	160	200	400
$C_R$ ( $\mu$ F)					
0.0010					
0.0015					
0.0022					
0.0027					
0.0033					
0.0047					
0.0068					
0.0082					
0.010					
0.012					
0.015					
0.022					
0.027					
0.033					
0.047					
0.056					
0.068					
0.10					
0.12					
0.15					
0.22					
0.33					
0.47					
0.68					
1.0					

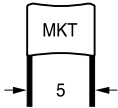
**B32559C**
**Compact design (stacked)**
**Ordering codes and packing units**

$V_R$	$V_{RMS}$ $f \leq 60$ Hz	$C_R$	Max. dimensions $w \times h \times l$	Ordering code (composition see below)	Ammo pack	Reel	Untaped
V DC	V AC	$\mu F$	mm		pcs./MOQ	pcs./MOQ	pcs./MOQ
63	40	0.22	$3.0 \times 6.5 \times 7.0$	B32559C0224+***	11200	9600	10000
		0.33	$3.0 \times 6.5 \times 7.0$	B32559C0334+***	12000	10400	10000
		0.47	$3.5 \times 7.0 \times 7.0$	B32559C0474+***	12000	10400	10000
		0.68	$3.5 \times 8.5 \times 7.0$	B32559C0684+***	9200	7600	8000
		1.0	$4.0 \times 10.5 \times 7.0$	B32559C0105+***	9200	7600	8000
100	63	0.033	$3.0 \times 6.5 \times 7.0$	B32559C1333+***	12000	10400	12000
		0.047	$3.0 \times 6.5 \times 7.0$	B32559C1473+***	12800	11200	12000
		0.056	$3.0 \times 7.0 \times 7.0$	B32559C1563+***	12000	10400	12000
		0.068	$3.0 \times 7.0 \times 7.0$	B32559C1683+***	12800	11200	12000
		0.10	$3.0 \times 7.0 \times 7.0$	B32559C1104+***	12800	11200	12000
		0.12	$3.0 \times 7.0 \times 7.0$	B32559C1124+***	12800	11200	12000
		0.15	$3.0 \times 7.0 \times 7.0$	B32559C1154+***	12800	11200	12000
		0.22	$3.5 \times 8.5 \times 7.0$	B32559C1224+***	11600	10000	12000
		0.33	$3.5 \times 8.5 \times 7.0$	B32559C1334+***	11600	10000	12000
		0.47	$3.5 \times 9.0 \times 7.0$	B32559C1474+***	10000	8400	10000
250	160	0.022	$3.0 \times 7.0 \times 7.0$	B32559C3223+***	12800	11200	12000
		0.027	$3.0 \times 7.0 \times 7.0$	B32559C3273+***	12800	11200	12000
		0.033	$3.0 \times 7.0 \times 7.0$	B32559C3333+***	12000	10400	12000
		0.047	$3.0 \times 7.0 \times 7.0$	B32559C3473+***	12800	11200	12000
		0.056	$3.0 \times 7.0 \times 7.0$	B32559C3563+***	10800	9200	1000
		0.068	$3.5 \times 7.0 \times 7.0$	B32559C3683+***	10800	9200	1000
		0.10	$3.5 \times 9.0 \times 7.0$	B32559C3104+***	12000	10400	8000
		0.12	$4.5 \times 9.0 \times 7.0$	B32559C3124+***	7200	5800	8000
				0.15	$4.5 \times 10.0 \times 7.0$	B32559C3154+***	7200

MOQ = Minimum Order Quantity, consisting of 4 packing units.

Further E series and intermediate capacitance values on request.

**Composition of ordering code**

+ = Capacitance tolerance code:

M =  $\pm 20\%$ 

K =  $\pm 10\%$ 

J =  $\pm 5\%$ 

\*\*\* = Packaging code:

489 = Ammo pack straight

389 = Reel straight

289 = Ammo pack crimped

189 = Reel crimped

000 = Untaped crimped (lead length 6 – 1 mm)

001 = Untaped (lead length 6 – 1 mm)

**Ordering codes and packing units**

$V_R$	$V_{RMS}$ $f \leq 60$ Hz	$C_R$	Max. dimensions $w \times h \times l$	Ordering code (composition see below)	Ammo pack	Reel	Untaped
V DC	V AC	$\mu F$	mm		pcs./MOQ	pcs./MOQ	pcs./MOQ
400	200	0.0068	$3.0 \times 7.0 \times 7.0$	B32559C6682+***	12800	11200	12000
		0.0082	$3.0 \times 7.0 \times 7.0$	B32559C6822+***	12800	11200	12000
		0.010	$3.0 \times 7.5 \times 7.0$	B32559C6103+***	12800	11200	12000
		0.012	$3.0 \times 7.5 \times 7.0$	B32559C6123+***	12000	10400	12000
		0.015	$3.0 \times 7.5 \times 7.0$	B32559C6153+***	11200	9600	12000
		0.022	$3.0 \times 8.0 \times 7.0$	B32559C6223+***	12800	11200	12000
		0.027	$3.0 \times 8.0 \times 7.0$	B32559C6273+***	10800	9200	11200
		0.033	$3.5 \times 8.0 \times 7.0$	B32559C6333+***	9200	7600	10000
		0.047	$3.5 \times 9.5 \times 7.0$	B32559C6473+***	9200	7600	8000
		0.056	$4.0 \times 10.0 \times 7.0$	B32559C6563+***	8000	6400	6000
		0.068	$5.0 \times 10.0 \times 7.0$	B32559C6683+***	7200	5600	7200
		0.10	$5.5 \times 12.5 \times 7.0$	B32559C6104+***	6000	4400	7200
		0.12	$5.5 \times 13.0 \times 7.0$	B32559C6124+***	6000	4400	4800
630	400	0.0010	$3.0 \times 7.0 \times 7.0$	B32559C8102+***	12800	11200	12000
		0.0015	$3.0 \times 7.0 \times 7.0$	B32559C8152+***	12800	11200	12000
		0.0022	$3.0 \times 8.0 \times 7.0$	B32559C8222+***	12800	11200	12000
		0.0027	$3.0 \times 8.0 \times 7.0$	B32559C8272+***	12800	11200	12000
		0.0033	$3.5 \times 8.0 \times 7.0$	B32559C8332+***	10000	8400	8000
		0.0047	$3.5 \times 8.0 \times 7.0$	B32559C8472+***	12000	10400	8000
		0.0068	$3.5 \times 10.5 \times 7.0$	B32559C8682+***	12000	10400	8000
		0.0082	$3.5 \times 10.5 \times 7.0$	B32559C8822+***	12000	10400	8000
		0.010	$4.0 \times 10.5 \times 7.0$	B32559C8103+***	9200	7600	8800

MOQ = Minimum Order Quantity, consisting of 4 packing units.

Further E series and intermediate capacitance values on request.

**Composition of ordering code**

+ = Capacitance tolerance code:

M =  $\pm 20\%$ 

K =  $\pm 10\%$ 

J =  $\pm 5\%$ 

\*\*\* = Packaging code:

489 = Ammo pack straight

389 = Reel straight

289 = Ammo pack crimped

189 = Reel crimped

000 = Untaped crimped (lead length 6 – 1 mm)

001 = Untaped (lead length 6 – 1 mm)

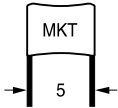
**B32559C**
**Compact design (stacked)**
**Technical data**

Operating temperature range	Max. operating temperature $T_{op,max}$	+125 °C	
	Upper category temperature $T_{max}$	+125 °C	
	Lower category temperature $T_{min}$	-55 °C	
	Rated temperature $T_R$	+85 °C	
Dissipation factor $\tan \delta$ (in $10^{-3}$ ) at 20 °C (upper limit values)	at	$C_R \leq 0.1 \mu F$	$0.1 \mu F < C_R \leq 1 \mu F$
	1 kHz	8	10
	10 kHz	15	20
	100 kHz	30	–
Insulation resistance $R_{ins}$ or time constant $\tau = C_R \cdot R_{ins}$ at 20 °C, rel. humidity $\leq 65\%$ (minimum as-delivered values)	$V_R$	$C_R \leq 0.33 \mu F$	$C_R > 0.33 \mu F$
	$\leq 100$ V DC	3750 M $\Omega$	1250 s
	$\geq 250$ V DC	7500 M $\Omega$	2500 s
DC test voltage	$1.4 \cdot V_R, 2$ s		
Category voltage $V_C$ (continuous operation with $V_{DC}$ or $V_{AC}$ at $f \leq 60$ Hz)	$T_A$ (°C)	DC voltage derating	AC voltage derating
	$T_A \leq 85$	$V_C = V_R$	$V_{C,RMS} = V_{RMS}$
	$85 < T_A \leq 125$	$V_C = V_R \cdot (165 - T_A)/80$	$V_{C,RMS} = V_{RMS} \cdot (165 - T_A)/80$
Operating voltage $V_{op}$ for short operating periods ( $V_{DC}$ or $V_{AC}$ at $f \leq 60$ Hz)	$T_A$ (°C)	DC voltage (max. hours)	AC voltage (max. hours)
	$T_A \leq 100$	$V_{op} = 1.25 \cdot V_C$ (2000 h)	$V_{op} = 1.0 \cdot V_{C,RMS}$ (2000 h)
	$100 < T_A \leq 125$	$V_{op} = 1.25 \cdot V_C$ (1000 h)	$V_{op} = 1.0 \cdot V_{C,RMS}$ (1000 h)
Damp heat test Limit values after damp heat test	56 days/40 °C/93% relative humidity		
	Capacitance change $ \Delta C/C $	$\leq 5\%$	
	Dissipation factor change $\Delta \tan \delta$	$\leq 5 \cdot 10^{-3}$ (at 1 kHz)	
	Insulation resistance $R_{ins}$ or time constant $\tau = C_R \cdot R_{ins}$	$\geq 50\%$ of minimum as-delivered values	
Reliability:			
Failure rate $\lambda$	1 fit ( $\leq 1 \cdot 10^{-9}$ /h) at $0.5 \cdot V_R, 40$ °C		
Service life $t_{SL}$	200 000 h at $1.0 \cdot V_R, 85$ °C		
	For conversion to other operating conditions and temperatures, refer to chapter "Quality, 2 Reliability".		
Failure criteria:			
Total failure	Short circuit or open circuit		
Failure due to variation of parameters	Capacitance change $ \Delta C/C $	$> 10\%$	
	Dissipation factor $\tan \delta$	$> 2 \cdot$ upper limit value	
	Insulation resistance $R_{ins}$ or time constant $\tau = C_R \cdot R_{ins}$	$< 150$ M $\Omega$ ( $C_R \leq 0.33 \mu F$ ) $< 50$ s ( $C_R > 0.33 \mu F$ )	
	Soldering conditions	Maximum solder bath temperature	260 °C
	Maximum soldering time	4 s	

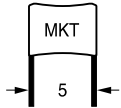

### Pulse handling capability

"dV/dt" represents the maximum permissible voltage change per unit of time for non-sinusoidal voltages, expressed in V/ $\mu$ s.

"k<sub>0</sub>" represents the maximum permissible pulse characteristic of the waveform applied to the capacitor, expressed in V<sup>2</sup>/ $\mu$ s.

*Note:*

*The values of dV/dt and k<sub>0</sub> provided below must not be exceeded in order to avoid damaging the capacitor.*

### dV/dt and k<sub>0</sub> values

V <sub>R</sub> (V DC)	V <sub>RMS</sub> (V AC)	dV/dt in V/ $\mu$ s	k <sub>0</sub> in V <sup>2</sup> / $\mu$ s
63	40	250	30 000
100	63	300	60 000
250	160	400	200 000
400	200	600	500 000
630	400	800	1 000 000

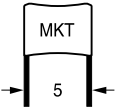

**B32559C**

**Compact design (stacked)**

**Impedance Z versus frequency f**

(typical values)

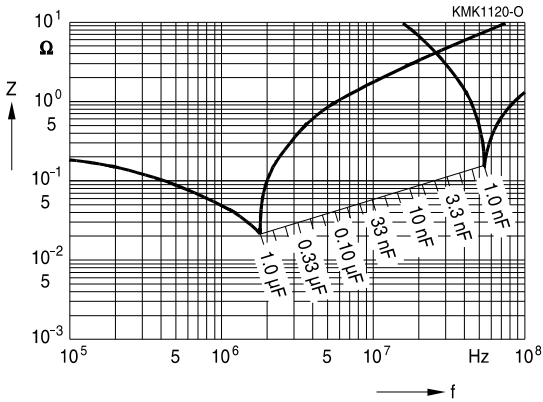



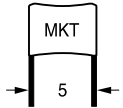

**Permissible AC voltage  $V_{RMS}$  versus frequency  $f$  (for sinusoidal waveforms,  $T_A \leq 55^\circ C$ )**

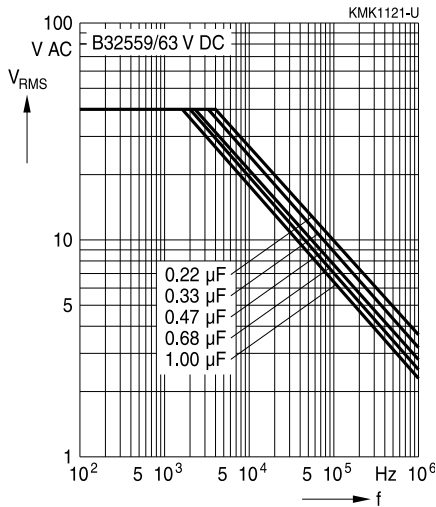
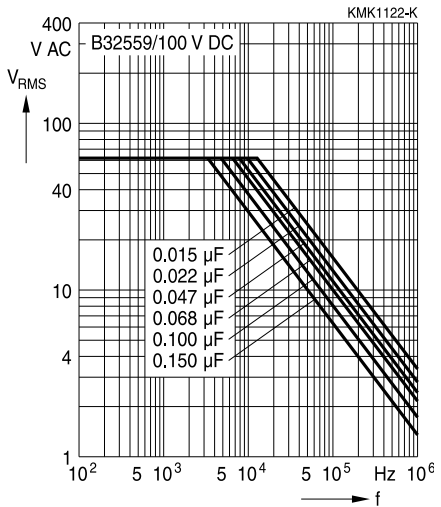
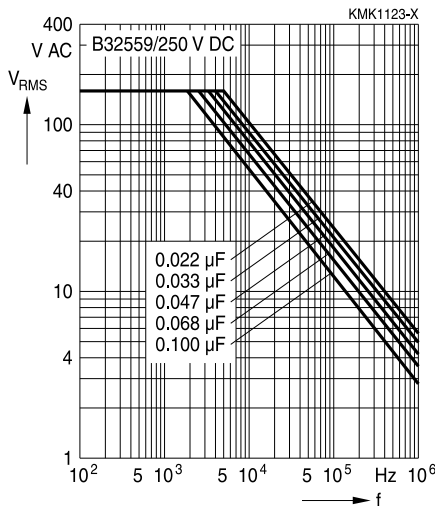
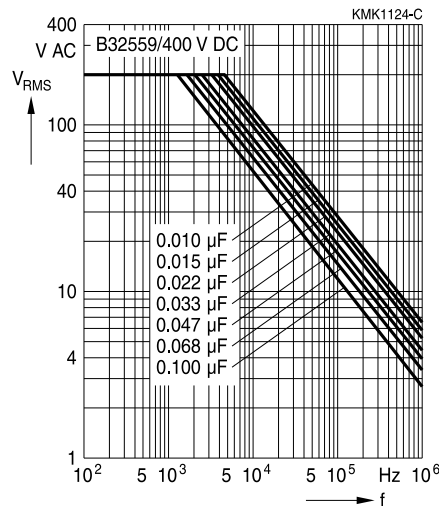
 For  $T_A > 55^\circ C$ , please refer to "General technical information", section 3.2.3.

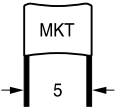
**Lead spacing 5 mm**
**63 V DC/40 V AC**

**100 V DC/63 V AC**

**250 V DC/160 V AC**

**400 V DC/200 V AC**



**B32559C**

**Compact design (stacked)**

**Permissible AC voltage  $V_{RMS}$  versus frequency  $f$  (for sinusoidal waveforms,  $T_A \leq 55^\circ C$ )**

For  $T_A > 55^\circ C$ , please refer to "General technical information", section 3.2.3.

**Lead spacing 5 mm**

630 V DC/400 V AC

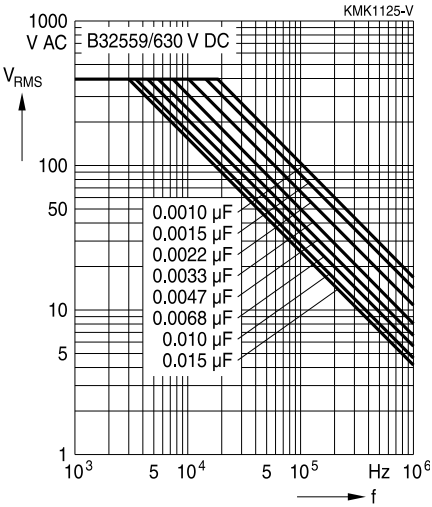

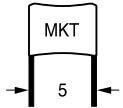
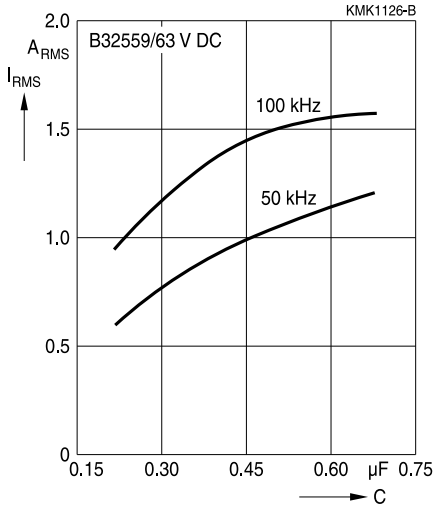
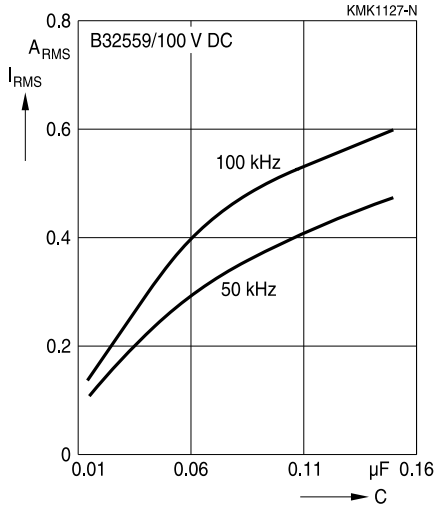
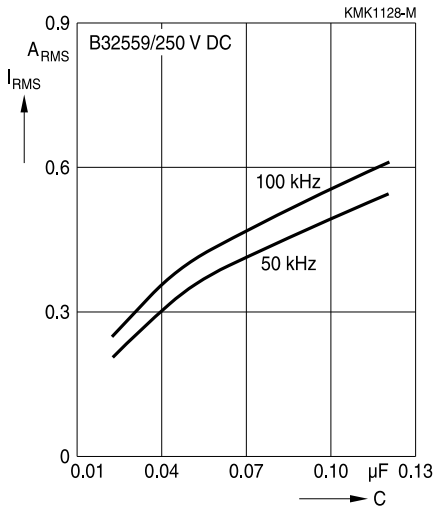
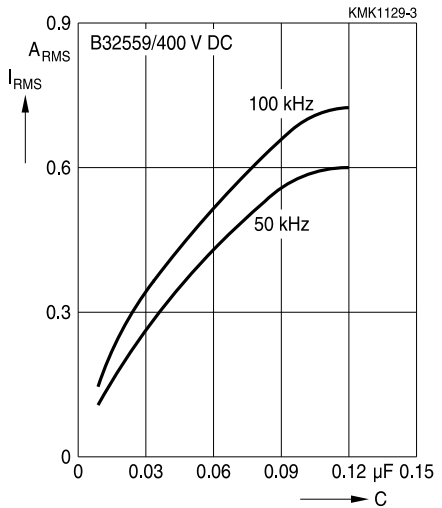
**Permissible AC current  $I_{RMS}$  versus frequency  $f$** 
**Lead spacing 5 mm**
**63 V DC/40 V AC**

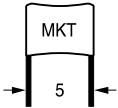
**100 V DC/63 V AC**

**250 V DC/160 V AC**

**400 V DC/200 V AC**



**B32559C**

**Compact design (stacked)**

**Permissible AC current  $I_{RMS}$  versus frequency  $f$**

**Lead spacing 5 mm**

**630 V DC/400 V AC**

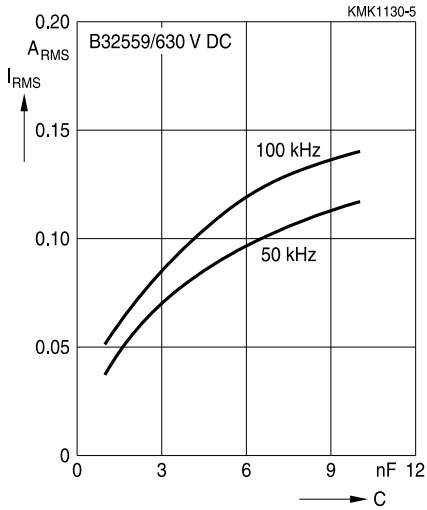

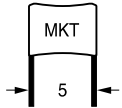

## Mounting guidelines

### 1 Soldering

#### 1.1 Solderability of leads

The solderability of terminal leads is tested to IEC 60068-2-20, test Ta, method 1.

Before a solderability test is carried out, terminals are subjected to accelerated ageing (to IEC 60068-2-2, test Ba: 4 h exposure to dry heat at 155 °C). Since the ageing temperature is far higher than the upper category temperature of the capacitors, the terminal wires should be cut off from the capacitor before the ageing procedure to prevent the solderability being impaired by the products of any capacitor decomposition that might occur.

Solder bath temperature	235 ±5 °C
Soldering time	2.0 ±0.5 s
Immersion depth	2.0 +0/-0.5 mm from capacitor body or seating plane
Evaluation criteria:	
Visual inspection	Wetting of wire surface by new solder ≥90%, free-flowing solder

#### 1.2 Resistance to soldering heat

Resistance to soldering heat is tested to IEC 60068-2-20, test Tb, method 1A.

Conditions:

Series	Solder bath temperature	Soldering time
MKT boxed (except 2.5 × 6.5 × 7.2 mm) coated uncoated (lead spacing > 10 mm)	260 ±5 °C	10 ±1 s
MFP MKP (lead spacing > 7.5 mm)		
MKT boxed (case 2.5 × 6.5 × 7.2 mm)		5 ±1 s
MKP (lead spacing ≤ 7.5 mm)		< 4 s
MKT uncoated (lead spacing ≤ 10 mm) insulated (B32559)		recommended soldering profile for MKT uncoated (lead spacing ≤ 10 mm) and insulated (B32559)

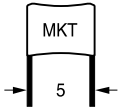

**B32559C**

**Compact design (stacked)**

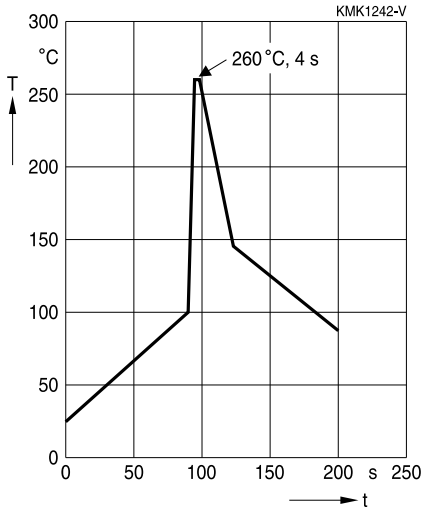

Immersion depth	2.0 +0/−0.5 mm from capacitor body or seating plane
Shield	Heat-absorbing board, (1.5 ±0.5) mm thick, between capacitor body and liquid solder
Evaluation criteria:	
Visual inspection	No visible damage
$\Delta C/C_0$	2% for MKT/MKP/MFP 5% for EMI suppression capacitors
$\tan \delta$	As specified in sectional specification

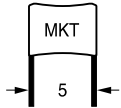

### 1.3 General notes on soldering

Permissible heat exposure loads on film capacitors are primarily characterized by the upper category temperature  $T_{max}$ . Long exposure to temperatures above this type-related temperature limit can lead to changes in the plastic dielectric and thus change irreversibly a capacitor's electrical characteristics. For short exposures (as in practical soldering processes) the heat load (and thus the possible effects on a capacitor) will also depend on other factors like:

- Pre-heating temperature and time
- Forced cooling immediately after soldering
- Terminal characteristics:
  - diameter, length, thermal resistance, special configurations (e.g. crimping)
- Height of capacitor above solder bath
- Shadowing by neighboring components
- Additional heating due to heat dissipation by neighboring components
- Use of solder-resist coatings

The overheating associated with some of these factors can usually be reduced by suitable countermeasures. For example, if a pre-heating step cannot be avoided, an additional or reinforced cooling process may possibly have to be included.

EPCOS recommends the following conditions:

- Pre-heating with a maximum temperature of 110 °C
- Temperature inside the capacitor should not exceed the following limits:
  - MKP/MFP 110 °C
  - MKT 160 °C
- When SMD components are used together with leaded ones, the leaded film capacitors should not pass into the SMD adhesive curing oven. The leaded components should be assembled after the SMD curing step.
- Leaded film capacitors are not suitable for reflow soldering.

#### Uncoated capacitors

For uncoated MKT capacitors with lead spacings  $\leq 10$  mm (B32560/B32561) the following measures are recommended:

- pre-heating to not more than 110 °C in the preheater phase
- rapid cooling after soldering

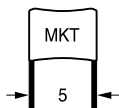
**B32559C**
**Compact design (stacked)**

## 2 Cleaning

To determine whether the following solvents, often used to remove flux residues and other substances, are suitable for the capacitors described, refer to the table below:

Type	Ethanol, isopropanol, n-propanol	n-propanol-water mixtures, water with surface tension-reducing tensides (neutral)	Solvent from table A (see next page)	Solvent from table B (see next page)
MKT (uncoated)	Suitable	Unsuitable	In part suitable	Unsuitable
MKT, MKP, MFP (coated/boxed)		Suitable	Suitable	

Even when suitable solvents are used, a reversible change of the electrical characteristics may occur in uncoated capacitors immediately after they are washed. Thus it is always recommended to dry the components (e.g. 4 h at 70 °C) before they are subjected to subsequent electrical testing.

### Table A

Manufacturers' designations for trifluoro-trichloro-ethane-based cleaning solvents (selection)

Trifluoro-trichloro-ethane	Mixtures of trifluoro-trichloro-ethane with ethanol and isopropanol	Manufacturer
Freon TF	Freon TE 35; Freon TP 35; Freon TES	Du Pont
Frigen 113 TR	Frigen 113 TR-E; Frigen 113 TR-P; Frigen TR-E 35	Hoechst
Arklone P	Arklone A; Arklone L; Arklone K	ICI
Kaltron 113 MDR	Kaltron 113 MDA; Kaltron 113 MDI; Kaltron 113 MDI 35	Kali-Chemie
Flugene 113	Flugene 113 E; Flugene 113 IPA	Rhone-Progil

### Table B (worldwide banned substances)

Manufacturers' designations for unsuitable cleaning solvents (selection)

Mixtures of chlorinated hydrocarbons and ketones with fluorated hydrocarbons	Manufacturer
Freon TMC; Freon TA; Freon TC	Du Pont
Arklone E	ICI
Kaltron 113 MDD; Kaltron 113 MDK	Kali-Chemie
Flugene 113 CM	Rhone-Progil



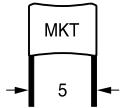

### 3 Embedding of capacitors in finished assemblies

In many applications, finished circuit assemblies are embedded in plastic resins. In this case, both chemical and thermal influences of the embedding ("potting") and curing processes must be taken into account.

Our experience has shown that the following potting materials can be recommended: non-flexible epoxy resins with acid-anhydride hardeners; chemically inert, non-conducting fillers; maximum curing temperature of 100 °C.

**Caution:**

Consult us first if you wish to embed uncoated types!

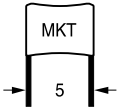

**B32559C**
**Compact design (stacked)**

### Cautions and warnings

- Do not exceed the upper category temperature (UCT).
- Do not apply any mechanical stress to the capacitor terminals.
- Avoid any compressive, tensile or flexural stress.
- Do not move the capacitor after it has been soldered to the PC board.
- Do not pick up the PC board by the soldered capacitor.
- Do not place the capacitor on a PC board whose PTH hole spacing differs from the specified lead spacing.
- Do not exceed the specified time or temperature limits during soldering.
- Avoid external energy inputs, such as fire or electricity.
- Avoid overload of the capacitors.

The table below summarizes the safety instructions that must always be observed. A detailed description can be found in the relevant sections of the chapters "General technical information" and "Mounting guidelines".

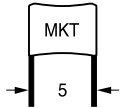
Topic	Safety information	Reference chapter "General technical information"
Storage conditions	Make sure that capacitors are stored within the specified range of time, temperature and humidity conditions.	4.5 "Storage conditions"
Flammability	Avoid external energy, such as fire or electricity (passive flammability), avoid overload of the capacitors (active flammability) and consider the flammability of materials.	5.3 "Flammability"
Resistance to vibration	Do not exceed the tested ability to withstand vibration. The capacitors are tested to IEC 60068-2-6. EPCOS offers film capacitors specially designed for operation under more severe vibration regimes such as those found in automotive applications. Consult our catalog "Film Capacitors for Automotive Electronics".	5.2 "Resistance to vibration"

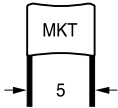

Topic	Safety information	Reference chapter "Mounting guidelines"
Soldering	Do not exceed the specified time or temperature limits during soldering.	1 "Soldering"
Cleaning	Use only suitable solvents for cleaning capacitors.	2 "Cleaning"
Embedding of capacitors in finished assemblies	When embedding finished circuit assemblies in plastic resins, chemical and thermal influences must be taken into account. Caution: Consult us first, if you also wish to embed other uncoated component types!	3 "Embedding of capacitors in finished assemblies"

**B32559C**
**Compact design (stacked)**
**Symbols and terms**

Symbol	English	German
$\alpha$	Heat transfer coefficient	Wärmeübergangszahl
$\alpha_C$	Temperature coefficient of capacitance	Temperaturkoeffizient der Kapazität
A	Capacitor surface area	Kondensatoroberfläche
$\beta_C$	Humidity coefficient of capacitance	Feuchtekoeffizient der Kapazität
C	Capacitance	Kapazität
$C_R$	Rated capacitance	Nennkapazität
$\Delta C$	Absolute capacitance change	Absolute Kapazitätsänderung
$\Delta C/C$	Relative capacitance change (relative deviation of actual value)	Relative Kapazitätsänderung (relative Abweichung vom Ist-Wert)
$\Delta C/C_R$	Capacitance tolerance (relative deviation from rated capacitance)	Kapazitätstoleranz (relative Abweichung vom Nennwert)
dt	Time differential	Differentielle Zeit
$\Delta t$	Time interval	Zeitintervall
$\Delta T$	Absolute temperature change (self-heating)	Absolute Temperaturänderung (Selbsterwärmung)
$\Delta \tan \delta$	Absolute change of dissipation factor	Absolute Änderung des Verlustfaktors
$\Delta V$	Absolute voltage change	Absolute Spannungsänderung
dV/dt	Time differential of voltage function (rate of voltage rise)	Differentielle Spannungsänderung (Spannungsflankensteilheit)
$\Delta V/\Delta t$	Voltage change per time interval	Spannungsänderung pro Zeitintervall
E	Activation energy for diffusion	Aktivierungsenergie zur Diffusion
ESL	Self-inductance	Eigeninduktivität
ESR	Equivalent series resistance	Ersatz-Serienwiderstand
f	Frequency	Frequenz
$f_1$	Frequency limit for reducing permissible AC voltage due to thermal limits	Grenzfrequenz für thermisch bedingte Reduzierung der zulässigen Wechselspannung
$f_2$	Frequency limit for reducing permissible AC voltage due to current limit	Grenzfrequenz für strombedingte Reduzierung der zulässigen Wechselspannung
$f_r$	Resonant frequency	Resonanzfrequenz
$F_D$	Thermal acceleration factor for diffusion	Therm. Beschleunigungsfaktor zur Diffusion
$F_T$	Derating factor	Deratingfaktor
i	Current (peak)	Stromspitze
$I_C$	Category current (max. continuous current)	Kategoriestrom (max. Dauerstrom)

Symbol	English	German
$I_{RMS}$	(Sinusoidal) alternating current, root-mean-square value	(Sinusförmiger) Wechselstrom
$i_z$	Capacitance drift	Inkonstanz der Kapazität
$k_0$	Pulse characteristic	Impuls Kennwert
$L_S$	Series inductance	Serieninduktivität
$\lambda$	Failure rate	Ausfallrate
$\lambda_0$	Constant failure rate during useful service life	Konstante Ausfallrate in der Nutzungsphase
$\lambda_{test}$	Failure rate, determined by tests	Experimentell ermittelte Ausfallrate
$P_{diss}$	Dissipated power	Abgegebene Verlustleistung
$P_{gen}$	Generated power	Erzeugte Verlustleistung
$Q$	Heat energy	Wärmeenergie
$\rho$	Density of water vapor in air	Dichte von Wasserdampf in Luft
$R$	Universal molar constant for gases	Allg. Molarkonstante für Gas
$R$	Ohmic resistance of discharge circuit	Ohmscher Widerstand des Entladekreises
$R_i$	Internal resistance	Innenwiderstand
$R_{ins}$	Insulation resistance	Isolationswiderstand
$R_P$	Parallel resistance	Parallelwiderstand
$R_S$	Series resistance	Serienwiderstand
$S$	severity (humidity test)	Schärfegrad (Feuchtest)
$t$	Time	Zeit
$T$	Temperature	Temperatur
$\tau$	Time constant	Zeitkonstante
$\tan \delta$	Dissipation factor	Verlustfaktor
$\tan \delta_D$	Dielectric component of dissipation factor	Dielektrischer Anteil des Verlustfaktors
$\tan \delta_P$	Parallel component of dissipation factor	Parallelanteil des Verlustfaktors
$\tan \delta_S$	Series component of dissipation factor	Serienanteil des Verlustfaktors
$T_A$	Ambient temperature	Umgebungstemperatur
$T_{max}$	Upper category temperature	Obere Kategorietemperatur
$T_{min}$	Lower category temperature	Untere Kategorietemperatur
$t_{OL}$	Operating life at operating temperature and voltage	Betriebszeit bei Betriebstemperatur und -spannung
$T_{op}$	Operating temperature	Betriebstemperatur
$T_R$	Rated temperature	Nenntemperatur
$T_{ref}$	Reference temperature	Referenztemperatur
$t_{SL}$	Reference service life	Referenz-Lebensdauer
$V_{AC}$	AC voltage	Wechselspannung

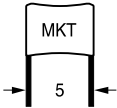
**B32559C**
**Compact design (stacked)**

Symbol	English	German
$V_C$	Category voltage	Kategoriespannung
$V_{C,RMS}$	Category AC voltage	(Sinusförmige) Kategorie-Wechselspannung
$V_{CD}$	Corona-discharge onset voltage	Teilentlade-Einsatzspannung
$V_{ch}$	Charging voltage	Ladespannung
$V_{DC}$	DC voltage	Gleichspannung
$V_{FB}$	Fly-back capacitor voltage	Spannung (Flyback)
$V_i$	Input voltage	Eingangsspannung
$V_o$	Output voltage	Ausgangssspannung
$V_{op}$	Operating voltage	Betriebsspannung
$V_p$	Peak pulse voltage	Impuls-Spitzenspannung
$V_{pp}$	Peak-to-peak voltage Impedance	Spannungshub
$V_R$	Rated voltage	Nennspannung
$\hat{V}_R$	Amplitude of rated AC voltage	Amplitude der Nenn-Wechselspannung
$V_{RMS}$	(Sinusoidal) alternating voltage, root-mean-square value	(Sinusförmige) Wechselspannung
$V_{SC}$	S-correction voltage	Spannung bei Anwendung "S-correction"
$V_{sn}$	Snubber capacitor voltage	Spannung bei Anwendung "Beschaltung"
$Z$	Impedance	Scheinwiderstand
$e$	Lead spacing	Rastermaß

## Important notes

The following applies to all products named in this publication:

1. Some parts of this publication contain **statements about the suitability of our products for certain areas of application**. These statements are based on our knowledge of typical requirements that are often placed on our products in the areas of application concerned. We nevertheless expressly point out **that such statements cannot be regarded as binding statements about the suitability of our products for a particular customer application**. As a rule, EPCOS is either unfamiliar with individual customer applications or less familiar with them than the customers themselves. For these reasons, it is always ultimately incumbent on the customer to check and decide whether an EPCOS product with the properties described in the product specification is suitable for use in a particular customer application.
2. We also point out that **in individual cases, a malfunction of electronic components or failure before the end of their usual service life cannot be completely ruled out in the current state of the art, even if they are operated as specified**. In customer applications requiring a very high level of operational safety and especially in customer applications in which the malfunction or failure of an electronic component could endanger human life or health (e.g. in accident prevention or lifesaving systems), it must therefore be ensured by means of suitable design of the customer application or other action taken by the customer (e.g. installation of protective circuitry or redundancy) that no injury or damage is sustained by third parties in the event of malfunction or failure of an electronic component.
3. **The warnings, cautions and product-specific notes must be observed.**
4. In order to satisfy certain technical requirements, **some of the products described in this publication may contain substances subject to restrictions in certain jurisdictions (e.g. because they are classed as hazardous)**. Useful information on this will be found in our Material Data Sheets on the Internet ([www.epcos.com/material](http://www.epcos.com/material)). Should you have any more detailed questions, please contact our sales offices.
5. We constantly strive to improve our products. Consequently, **the products described in this publication may change from time to time**. The same is true of the corresponding product specifications. Please check therefore to what extent product descriptions and specifications contained in this publication are still applicable before or when you place an order. We also **reserve the right to discontinue production and delivery of products**. Consequently, we cannot guarantee that all products named in this publication will always be available. The aforementioned does not apply in the case of individual agreements deviating from the foregoing for customer-specific products.
6. Unless otherwise agreed in individual contracts, **all orders are subject to the current version of the "General Terms of Delivery for Products and Services in the Electrical Industry" published by the German Electrical and Electronics Industry Association (ZVEI)**.
7. The trade names EPCOS, BAOKE, Alu-X, CeraDiode, CSMP, CSSP, CTVS, DSSP, MiniBlue, MKK, MLSC, MotorCap, PCC, PhaseCap, PhaseCube, PhaseMod, SIFERRIT, SIFI, SIKOREL, SilverCap, SIMDAD, SIMID, SineFormer, SIOV, SIP5D, SIP5K, ThermoFuse, WindCap are **trademarks registered or pending** in Europe and in other countries. Further information will be found on the Internet at [www.epcos.com/trademarks](http://www.epcos.com/trademarks).