

LED NUMERIC DISPLAY, 1 DIGIT
BL-S56X-14
Features:

- 14.20mm (0.56") Single digit numeric display series.
- Low current operation.
- Excellent character appearance.
- Easy mounting on P.C. Boards or sockets.
- I.C. Compatible.
- ROHS Compliance.

Super Bright
Electrical-optical characteristics: (Ta=25°C) (Test Condition: IF=20mA)

| Part No | | Chip | | | VF Unit:V | | Iv TYP.(mcd) |
|-----------------|-----------------|---------------|-----------------|------------------|-----------|------|--------------|
| Common Cathode | Common Anode | Emitted Color | Material | λ_p (nm) | Typ | Max | |
| BL-S56A-14S-XX | BL-S56B-14S-XX | Hi Red | GaAlAs/GaAs,SH | 660 | 1.85 | 2.20 | 30 |
| BL-S56A-14D-XX | BL-S56B-14D-XX | Super Red | GaAlAs/GaAs,DH | 660 | 1.85 | 2.20 | 45 |
| BL-S56A-14UR-XX | BL-S56B-14UR-XX | Ultra Red | GaAlAs/GaAs,DDH | 660 | 1.85 | 2.20 | 50 |
| BL-S56A-14E-XX | BL-S56B-14E-XX | Orange | GaAsP/GaP | 635 | 2.10 | 2.50 | 35 |
| BL-S56A-14Y-XX | BL-S56B-14Y-XX | Yellow | GaAsP/GaP | 585 | 2.10 | 2.50 | 35 |
| BL-S56A-14G-XX | BL-S56B-14G-XX | Green | GaP/GaP | 570 | 2.20 | 2.50 | 35 |

Ultra Bright
Electrical-optical characteristics: (Ta=25°C) (Test Condition: IF=20mA)

| Part No | | Chip | | | VF Unit:V | | Iv TYP.(mcd) |
|------------------|------------------|------------------|----------|------------------|-----------|------|--------------|
| Common Cathode | Common Anode | Emitted Color | Material | λ_p (nm) | Typ | Max | |
| BL-S56A-14UHR-XX | BL-S56B-14UHR-XX | Ultra Red | AlGaInP | 645 | 2.10 | 2.50 | 50 |
| BL-S56A-14UE-XX | BL-S56B-14UE-XX | Ultra Orange | AlGaInP | 630 | 2.10 | 2.50 | 38 |
| BL-S56A-14YO-XX | BL-S56B-14YO-XX | Ultra Amber | AlGaInP | 619 | 2.10 | 2.50 | 38 |
| BL-S56A-14UY-XX | BL-S56B-14UY-XX | Ultra Yellow | AlGaInP | 590 | 2.10 | 2.50 | 38 |
| BL-S56A-14UG-XX | BL-S56B-14UG-XX | Ultra Green | AlGaInP | 574 | 2.20 | 2.50 | 45 |
| BL-S56A-14PG-XX | BL-S56B-14PG-XX | Ultra Pure Green | InGaN | 525 | 3.80 | 4.50 | 60 |
| BL-S56A-14B-XX | BL-S56B-14B-XX | Ultra Blue | InGaN | 470 | 2.70 | 4.20 | 58 |
| BL-S56A-14W-XX | BL-S56B-14W-XX | Ultra White | InGaN | / | 2.70 | 4.20 | 65 |

-XX: Surface / Lens color:

| Number | 0 | 1 | 2 | 3 | 4 | 5 |
|--------------------------|-------------|----------------|--------------|----------------|-----------------|---|
| Ref Surface Color | White | Black | Gray | Red | Green | |
| Epoxy Color | Water clear | White diffused | Red Diffused | Green Diffused | Yellow Diffused | |

LED NUMERIC DISPLAY, 1 DIGIT
BL-S56X-14
Absolute maximum ratings (Ta=25°C)

| Parameter | S | D | UR | E | Y | G | Unit |
|--|---|-----|-----|-----|-----|-----|------|
| Forward Current I_F | 25 | 25 | 25 | 25 | 25 | 30 | mA |
| Power Dissipation P_d | 60 | 60 | 60 | 60 | 60 | 65 | mW |
| Reverse Voltage V_R | 5 | 5 | 5 | 5 | 5 | 5 | V |
| Peak Forward Current I_{PF} (Duty 1/10 @1KHZ) | 150 | 150 | 150 | 150 | 150 | 150 | mA |
| Operation Temperature T_{OPR} | -40 to +80 | | | | | | °C |
| Storage Temperature T_{STG} | -40 to +85 | | | | | | °C |
| Lead Soldering Temperature T_{SOL} | Max.260±5°C for 3 sec Max. (1.6mm from the base of the epoxy bulb) | | | | | | °C |

■ Absolute maximum ratings (Ta=25°C)

| Parameter | UHR | UE | YO | UY | UG | PG | UB | UW | Unit |
|--|---|-----|-----|-----|-----|-----|-----|-----|------|
| Forward Current I_F | 30 | 30 | 30 | 30 | 30 | 30 | 30 | 30 | mA |
| Power Dissipation P_d | 75 | 65 | 65 | 65 | 75 | 110 | 120 | 120 | mW |
| Reverse Voltage V_R | 5 | 5 | 5 | 5 | 5 | 5 | 5 | 5 | V |
| Peak Forward Current I_{PF} (Duty 1/10 @1KHZ) | 150 | 150 | 150 | 150 | 150 | 150 | 100 | 100 | mA |
| Operation Temperature T_{OPR} | -40 to +80 | | | | | | | | °C |
| Storage Temperature T_{STG} | -40 to +85 | | | | | | | | °C |
| Lead Soldering Temperature T_{SOL} | Max.260±5°C for 3 sec Max. (1.6mm from the base of the epoxy bulb) | | | | | | | | °C |

LED NUMERIC DISPLAY, 1 DIGIT

BL-S56X-14

■ Package configuration & Internal circuit diagram

BL-S56X-14 Series

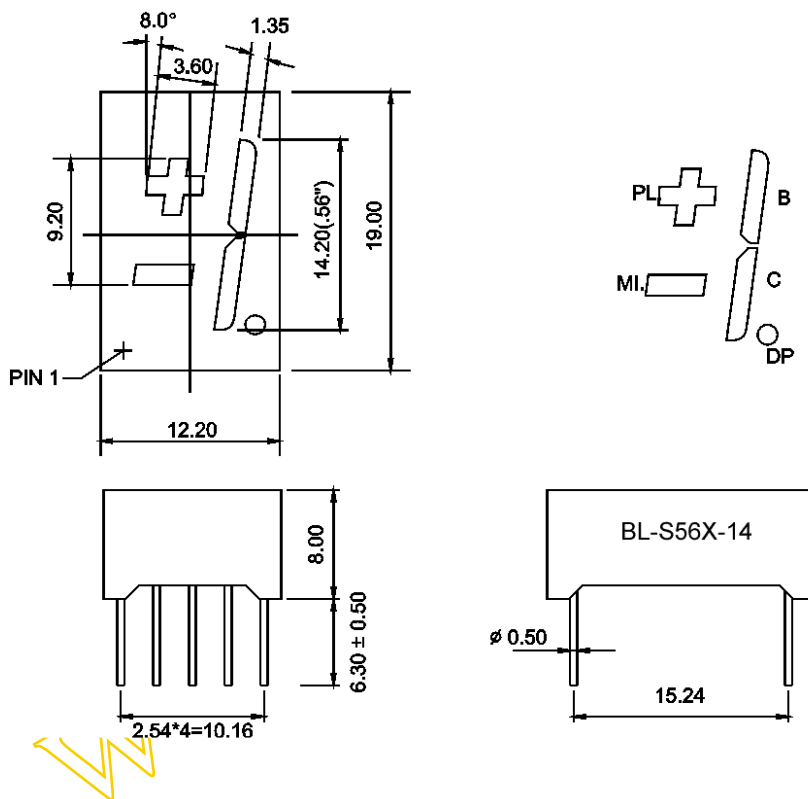

BL-S56A-14

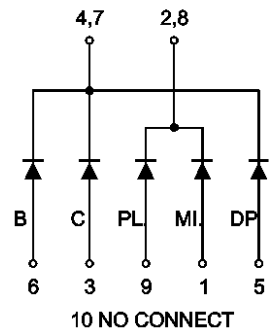

BL-S56B-14

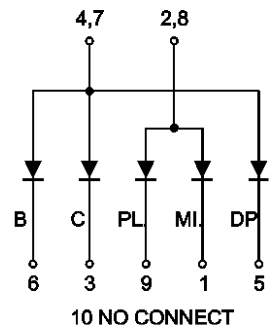

Notes:

1. All dimensions are in millimeters (inches)
2. Tolerance is $\pm 0.25(0.01)$ unless otherwise noted.
3. Specifications are subject to change without notice.

LED NUMERIC DISPLAY, 1 DIGIT

BL-S56X-14

Typical electrical-optical characteristics curves:



- | | |
|---|--------------------------------------|
| (1) - GaAsP/GaAs 655nm/Red | (9) - GaAlAs 880nm |
| (2) - GaP 570nm/Yellow Green | (10) - GaAs/GaAs & GaAlAs/GaAs 940nm |
| (3) - GaAsP/GaP 585nm/Yellow | (A) - GaN/SiC 430nm/Blue |
| (4) - GaAsP/GaP 635nm/Orange & Hi-Eff Red | (B) - InGaN/SiC 470nm/Blue |
| (5) - GaP 700nm/Bright Red | (C) - InGaN/SiC 505nm/Ultra Green |
| (6) - GaAlAs/GaAs 660nm/Super Red | (D) - InGaN/SiC 525nm/Ultra Green |
| (8) - GaAsP/GaP 610nm/Super Red | |

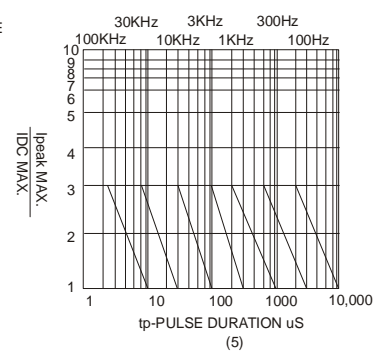
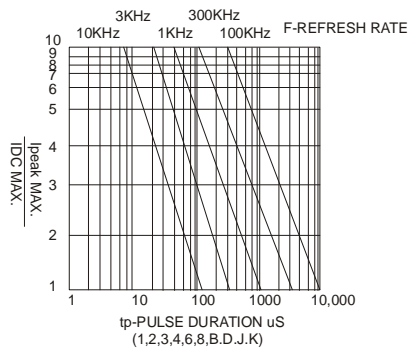
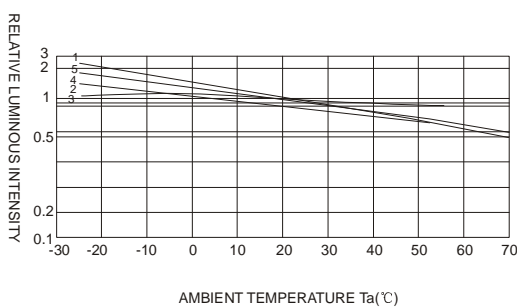
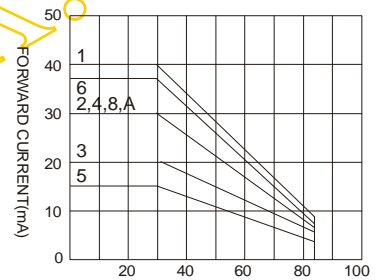
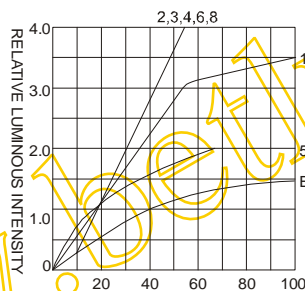

NOTE:25°C free air temperature unless otherwise specified