

FEATURES

KEMET's Open Mode Ceramic Surface Mount Capacitor is designed to significantly minimize the probability of a low IR or Short Circuit Condition when forced to failure in a board flex situation. This reduces the potential for causing catastrophic failures. This product is RoHS Compliant.

Applications:

- Input side filtering (power plane/bus)
- High current applications (battery line)
- Circuits that cannot be fused to open when short circuits occur due to flex cracks

Markets:

- *Automotive*
 - All applications connected directly to the battery
 - Conversion to 42V power system
- *Power Conversion*
 - Raw power input side filtering

OUTLINE DRAWING

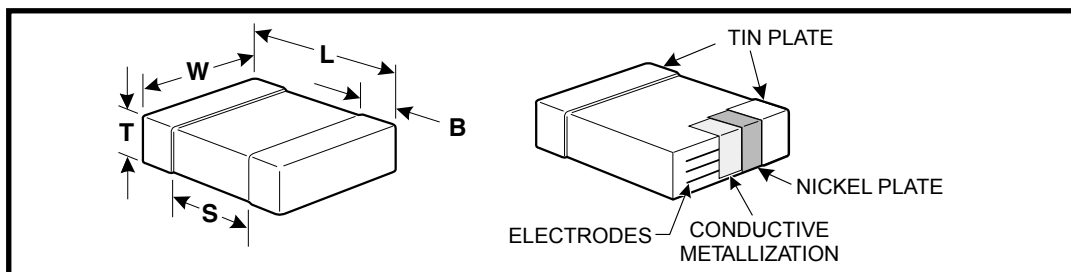
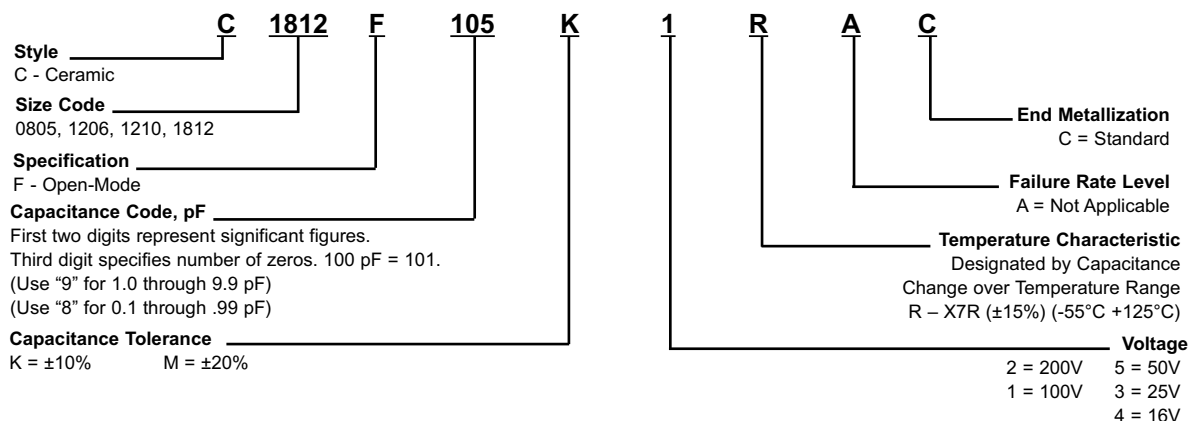

TABLE 1 - DIMENSIONS - MILLIMETERS (INCHES)

Metric Size Code	EIA Size Code	L - Length	W - Width	B - Bandwidth	Separation
2012	0805	2.0 (.079) ± .20 (.008)	1.25 (.049) ± 0.2 (.008)	0.50 (.02) ± .25 (.010)	0.75 (.030)
3216	1206	3.2 (.126) ± .20 (.008)	1.6 (.063) ± 0.2 (.008)	0.50 (.02) ± .25 (.010)	N/A
3225	1210	3.2 (.126) ± .20 (.008)	2.5 (.098) ± 0.2 (.008)	0.50 (.02) ± .25 (.010)	N/A
4532	1812	4.5 (.177) ± 0.3 (.012)	3.2 (.126) ± 0.3 (.012)	0.60 (.024) ± .35 (.014)	N/A

Note: For thickness dimensions, see Table 2.

CAPACITOR ORDERING INFORMATION



OPEN-MODE INTERNAL DESIGN

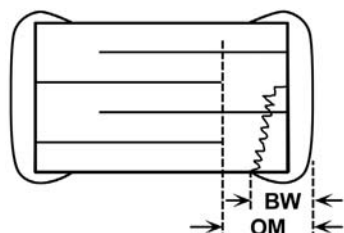

The open-mode dimension (OM) exceeds the termination bandwidth dimensions: OM > BW

Ceramic Surface Mount

TABLE 2
X7R DIELECTRIC CAPACITANCE RANGE AND THICKNESS TARGETS (mm)

Cap Code	0805					1206					1210					1812				
	16V	25V	50V	100V	200V	16V	25V	50V	100V	200V	16V	25V	50V	100V	200V	25V	50V	100V	200V	
102	DD	DD	DD	DD	DD															
122	DD	DD	DD	DD	DD															
152	DD	DD	DD	DD	DD															
182	DD	DD	DD	DD	DD															
222	DD	DD	DD	DD	DD															
272	DD	DD	DD	DD	DD															
332	DD	DD	DD	DD	DD															
392	DD	DD	DD	DD	DD															
472	DD	DD	DD	DD	DD															
562	DD	DD	DD	DD	DD															
682	DD	DD	DD	DD	DD															
822	DD	DD	DD	DD	DD															
103	DD	DD	DD	DD	DD															
123	DD	DD	DD	DD	DG															
153	DD	DD	DD	DD	DG															
183	DD	DD	DD	DD						EC										
223	DD	DD	DD	DG						EC										
273	DD	DD	DD	DG						EC										
333	DD	DD	DD	DG						EC										
393	DD	DD	DD	DG						EC										
473	DD	DD	DD	DE		EC	EC	EC	EC	EG										GB
563	DD	DD	DD			EC	EC	EC	EC	EG										GB
683	DD	DD	DG	DG		EC	EC	EC	EC	EG					FD					GB
823	DD	DD	DG			EC	EC	EC	EC	EG					FD					GB
104	DG	DG	DG			EC	EC	EC	EC	EG	FD	FD	FD	FD	FG	GB	GB	GB	GB	GB
124	DG	DG				EC	EC	EC	EC		FD	FD	FD	FD	FG	GB	GB	GB	GB	GB
154	DG	DG				EC	EC	EC	EG		FD	FD	FD	FD	FH	GB	GB	GB	GB	GB
184	DG	DG				EC	EC	EC	EG		FD	FD	FD	FD	FH	GB	GB	GB	GB	GB
224	DG	DD	DG			EC	EC	EC	ED		FD	FD	FD	FG	FJ	GB	GB	GB	GB	GC
274						EC	EC	EC			FD	FD	FD	FG		GB	GB	GB	GB	GF
334						EG	EG	EG	EG		FD	FD	FD	FH		GB	GB	GB	GB	GK
394						EG	EG				FD	FD	FG	FH		GB	GB	GB	GB	GL
474	DE	DG				EG	EG	EC			FD	FD	FG	FJ		GB	GB	GC		
564						EG					FD	FD	FG	FR		GB	GB	GD		
684	DG					EG					FD	FG	FH	FR		GD	GD	GF		
824						EG					FD	FG	FJ			GD	GD	GK		
105						EG	EC	EH			FD	FH	FJ	FQ		GN	GN	GM		
125											FG									
155											FH									
185											FH									
225						EC	EH				FJ		FM							
475						EH					FG	FM								
685											FQ									

THICKNESS AND PACKAGING INFORMATION

Thickness Code	Series	Dimension	7" Reel Qty.	13" Reel Qty.
DD	0805	.90 ± .10	4000	10000
DE	0805	1.00 ± .10	2500	10000
DG	0805	1.25 ± .15	2500	10000
EC	1206	.90 ± .10	4000	10000
EG	1206	1.60 ± .15	2000	8000
EH	1206	1.60 ± .20	2000	8000
FD	1210	.95 ± .10	4000	10000
FG	1210	1.25 ± .15	2500	10000
FH	1210	1.55 ± .15	2000	8000
FJ	1210	1.85 ± .20	2000	8000
FM	1210	1.70 ± .20	2000	8000
FR	1210	2.25 ± .20	2000	8000
FQ	1210	2.5 ± .20	1500	8000
GB	1812	1.0 ± .10	1000	4000
GC	1812	1.1 ± .10	1000	4000
GD	1812	1.25 ± .15	1000	4000
GF	1812	1.50 ± .15	1000	4000
GK	1812	1.60 ± .20	1000	4000
GL	1812	1.90 ± .20	1000	4000
GM	1812	2.00 ± .20	1000	4000
GN	1812	1.70 ± .20	1000	4000

Tape & Reel Packaging

KEMET offers Multilayer Ceramic Chip Capacitors packaged in 8mm and 12mm plastic tape on 7" and 13" reels in accordance with EIA standard 481-1: Taping of surface mount components for automatic handling. This packaging system is compatible with all tape fed automatic pick and place systems. See page 78 for details on reeling quantities for commercial chips and page 87 for MIL-PRF-55681 chips.

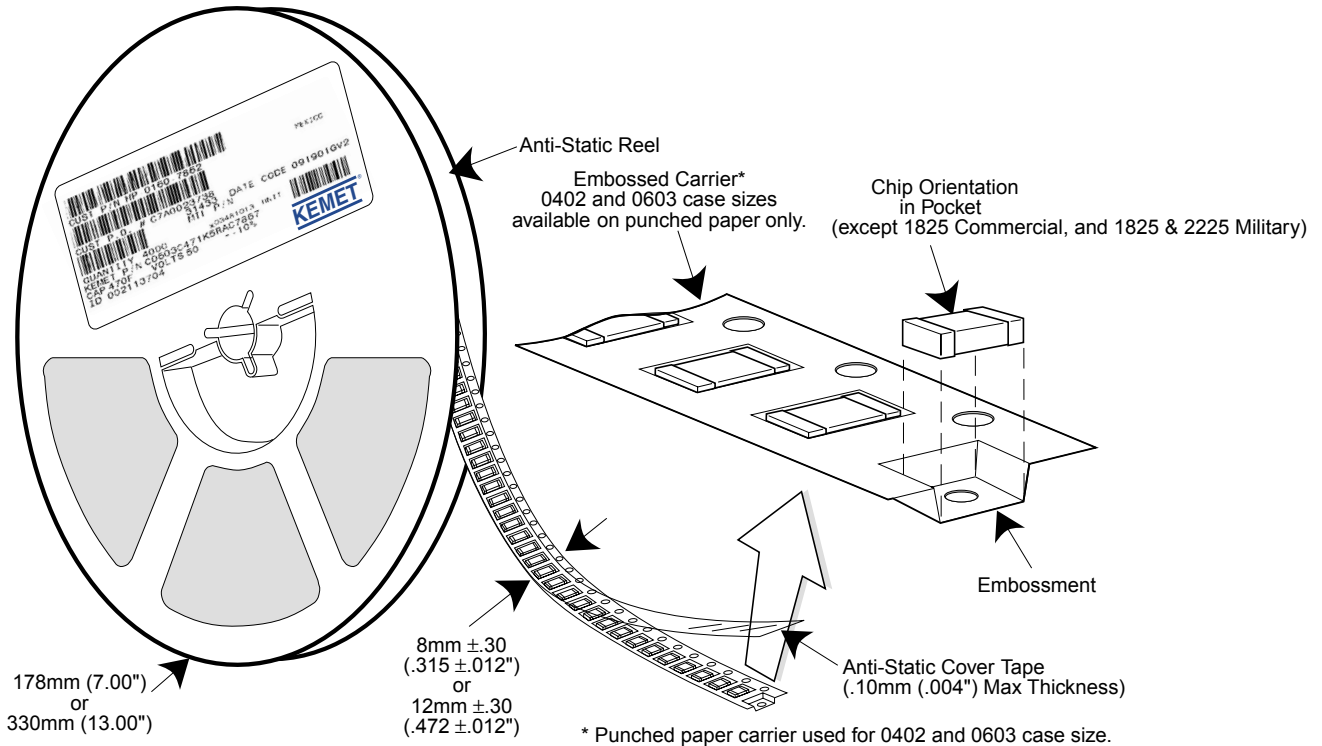

SURFACE MOUNT LAND DIMENSIONS - CERAMIC CHIP CAPACITORS - MM

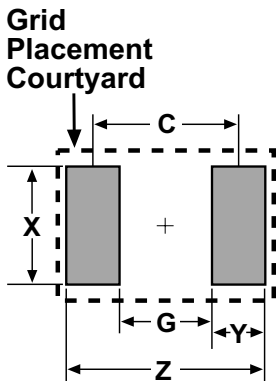

Dimension	Reflow Solder					Wave Solder				
	Z	G	X	Y(ref)	C(ref)	Z	G	X	Y(ref)	Smin
0402	2.14	0.28	0.74	0.93	1.21	Not Recommended				
0603	2.78	0.68	1.08	1.05	1.73	3.18	0.68	0.80	1.25	1.93
0805	3.30	0.70	1.60	1.30	2.00	3.70	0.70	1.10	1.50	2.20
1206	4.50	1.50	2.00	1.50	3.00	4.90	1.50	1.40	1.70	3.20
1210	4.50	1.50	2.90	1.50	3.00	4.90	1.50	2.00	1.70	3.20
1812	5.90	2.30	3.70	1.80	4.10	Not Recommended				
1825	5.90	2.30	6.90	1.80	4.10					
2220	7.00	3.30	5.50	1.85	5.15					
2225	7.00	3.30	6.80	1.85	5.15	Not Recommended				

Calculation Formula
 $Z = L_{min} + 2J_t + T_t$
 $G = S_{max} - 2J_h - T_h$
 $X = W_{min} + 2J_s + T_s$
 $T_t, T_h, T_s =$ Combined tolerances

TANTALUM, CERAMIC AND ALUMINUM CHIP CAPACITORS

Packaging Information

Performance Notes

- Cover Tape Break Force:** 1.0 Kg Minimum.
- Cover Tape Peel Strength:** The total peel strength of the cover tape from the carrier tape shall be:

Tape Width	Peel Strength
8 mm	0.1 Newton to 1.0 Newton (10g to 100g)
12 mm	0.1 Newton to 1.3 Newton (10g to 130g)

The direction of the pull shall be opposite the direction of the carrier tape travel. The pull angle of the carrier tape shall be 165° to 180° from the plane of the carrier tape. During peeling, the carrier and/or cover tape shall be pulled at a velocity of 300 ±10 mm/minute.

- Reel Sizes:** Molded tantalum capacitors are available on either 180 mm (7") reels (standard) or 330 mm (13") reels (with C-7280). Note that 13" reels are preferred.
- Labeling:** Bar code labeling (standard or custom) shall be on the side of the reel opposite the sprocket holes. Refer to EIA-556.

Embossed Carrier Tape Configuration: Figure 1

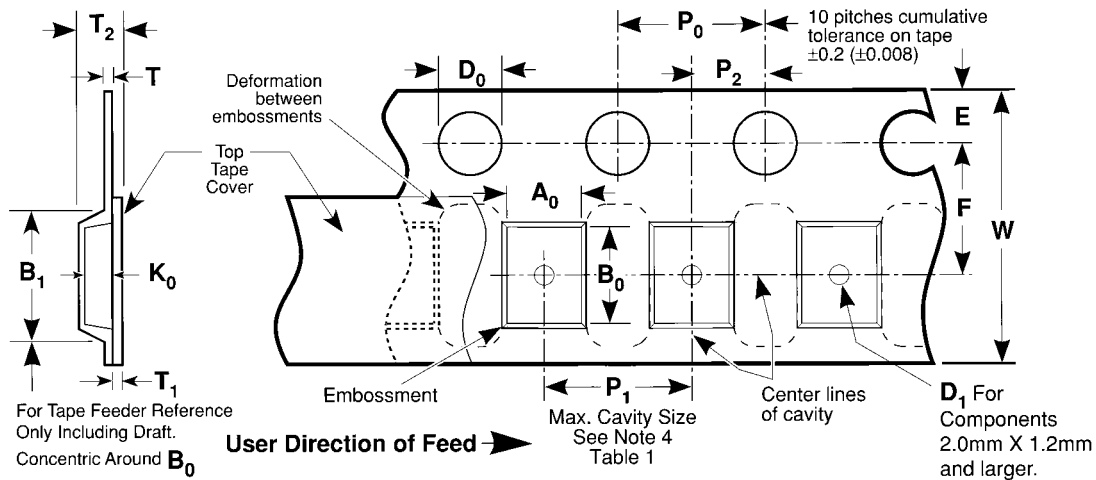

Table 1 — EMBOSSED TAPE DIMENSIONS (Metric will govern)

Constant Dimensions — Millimeters (Inches)									
Tape Size	D ₀	E	P ₀	P ₂	T Max	T ₁ Max			
8 mm and 12 mm	1.5 +0.10 -0.0 (0.059 +0.004, -0.0)	1.75 ±0.10 (0.069 ±0.004)	4.0 ±0.10 (0.157 ±0.004)	2.0 ±0.05 (0.079 ±0.002)	0.600 (0.024)	0.100 (0.004)			
Variable Dimensions — Millimeters (Inches)									
Tape Size	Pitch	B ₁ Max. Note 1	D ₁ Min. Note 2	F	P ₁	R Min. Note 3	T ₂ Max	W	A ₀ B ₀ K ₀ Note 4
8 mm	Single (4 mm)	4.4 (0.173)	1.0 (0.039)	3.5 ±0.05 (0.138 ±0.002)	4.0 ±0.10 (0.157 ±0.004)	25.0 (0.984)	2.5 (0.098)	8.0 ±0.30 (.315 ±0.012)	
12 mm	Double (8 mm)	8.2 (0.323)	1.5 (0.059)	5.5 ±0.05 (0.217 ±0.002)	8.0 ±0.10 (0.315 ±0.004)	30.0 (1.181)	4.6 (0.181)	12.0 ±0.30 (0.472 ±0.012)	

NOTES

- B₁ dimension is a reference dimension for tape feeder clearance only.
- The embossment hole location shall be measured from the sprocket hole controlling the location of the embossment. Dimensions of embossment location and hole location shall be applied independent of each other.
- Tape with components shall pass around radius "R" without damage (see sketch A). The minimum trailer length (Fig. 2) may require additional length to provide R min. for 12 mm embossed tape for reels with hub diameters approaching N min. (Table 2)
- The cavity defined by A₀, B₀, and K₀ shall be configured to surround the part with sufficient clearance such that the chip does not protrude beyond the sealing plane of the cover tape, the chip can be removed from the cavity in a vertical direction without mechanical restriction, rotation of the chip is limited to 20 degrees maximum in all 3 planes, and lateral movement of the chip is restricted to 0.5 mm maximum in the pocket (not applicable to vertical clearance.)

Packaging Information

Embossed Carrier Tape Configuration (cont.)

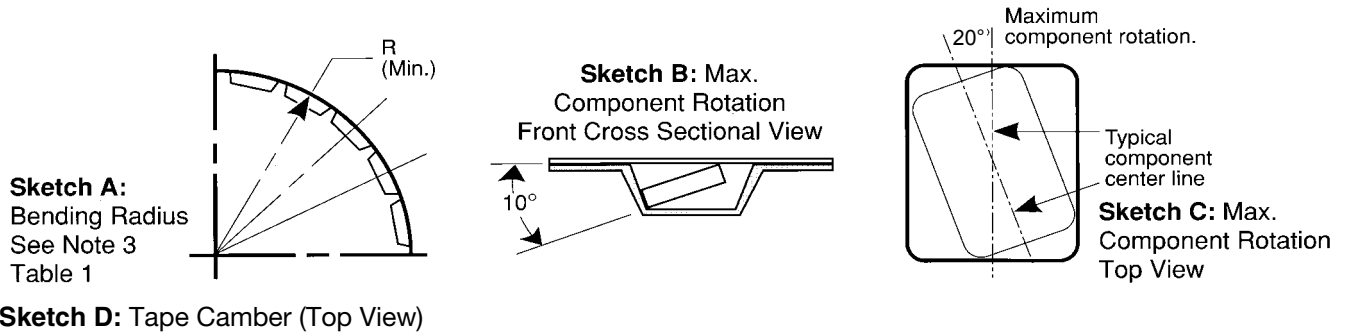

Sketch D: Tape Camber (Top View)

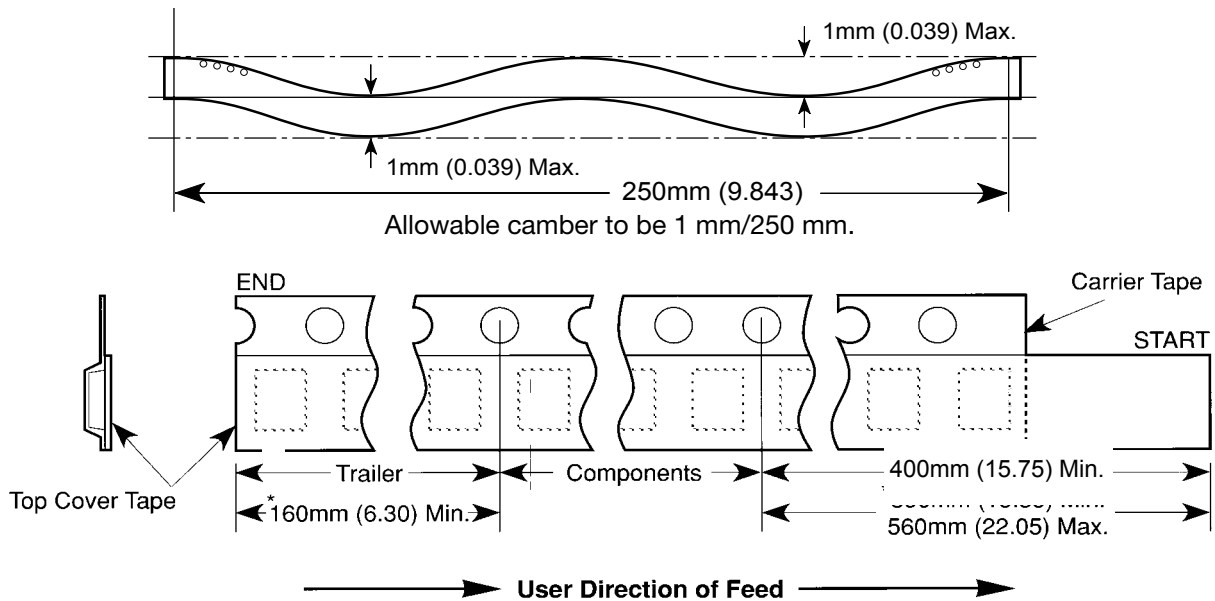

Figure 2: Tape Leader & Trailer Dimensions (Metric Dimensions Will Govern)

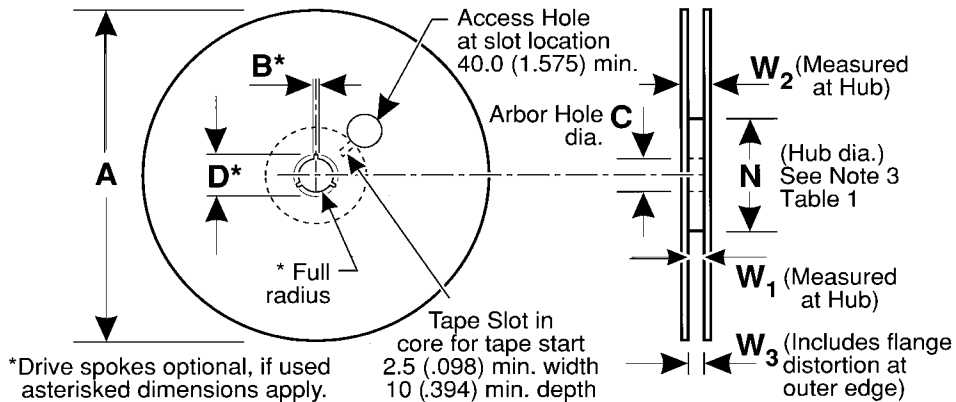

Figure 3: Reel Dimensions (Metric Dimensions will govern)

Table 2 – REEL DIMENSIONS (Metric will govern)

Tape Size	A Max	B^* Min	C	D^* Min	N Min	W_1	W_2 Max	W_3
8 mm	330.0 (12.992)	1.5 (0.059)	13.0 ± 0.20 (0.512 ± 0.008)	20.2 (0.795)	50.0 (1.969) See Note 3 Table 1	8.4 +1.5, -0.0 (0.331 +0.059, -0.0)	14.4 (0.567)	7.9 Min (0.311) 10.9 Max (0.429)
12 mm	330.0 (12.992)	1.5 (0.059)	13.0 ± 0.20 (0.512 ± 0.008)	20.2 (0.795)	Table 1	12.4 +2.0, -0.0 (0.488 +0.078, -0.0)	18.4 (0.724)	11.9 Min (0.469) 15.4 Max (0.606)

Punched Carrier (Paper Tape) Configuration (Ceramic Chips Only):

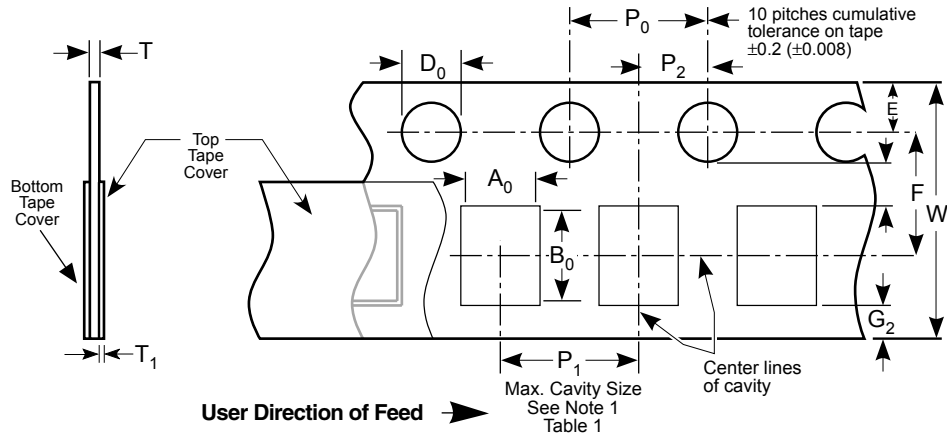

Table 1: 8 & 12mm Punched Tape
(Metric Dimensions Will Govern)

Constant Dimensions - Millimeters (Inches)

Tape Size	D ₀	E	P ₀	P ₂	T ₁	G ₁	G ₂	R Min.
8mm and 12mm	1.5 +0.10, -0.0 (.059 +0.004, -0.0)	1.75 ±0.10 (.069 ±0.004)	4.0 ± 0.10 (.157 ± 0.004)	2.0 ± 0.05 (.079 ± 0.002)	0.10 (.004) Max.	0.75 (.030) Min.	0.75 (.030) Min.	25 (.984) See Note 2 Table 1

Table 1: 8 & 12mm Punched Tape
(Metric Dimensions Will Govern)

Variable Dimensions - Millimeters (Inches)

Tape Size	P ₁	F	W	A ₀ B ₀	T
8mm 1/2 Pitch	2.0 ± 0.10 (.079 ± .004) See Requirements Section 3.3 (d)	3.5 ± 0.05 (.138 ± .002)	8.0 ± 0.3 (.315 ± 0.012)	See Note 1 Table 1	1.1mm (.043) Max. for Paper Base Tape and 1.6mm (.063) Max. for Non- Paper Base Compositions. See Note 3.
8mm	4.0 ± 0.10 (0.157 ± .004)				
12mm	4.0 ± 0.10 (0.157 ± .004)	5.5 ± 0.05 (.217 ± .002)	12.0 ± 0.3 (.472 ± .012)		
12mm Double Pitch	8.0 ± 0.10 (0.315 ± .004)				

Note:

- A₀, B₀ and T determined by the maximum dimensions to the ends of the terminals extending from the body and/or the body dimensions of the component. The clearance between the ends of the terminals or body of the component to the sides and depth of the cavity (A₀, B₀ and T) must be within 0.05mm (.002) minimum and 0.50mm (.020) maximum. The clearance allowed must also prevent rotation of the component within the cavity of not more than 20 degrees (see sketches A and B).
- Tape with components shall pass around radius "R" without damage.
- KEMET nominal thicknesses are: 0402 = 0.6mm and all others 0.95mm minimum.

Sketch A:
Bending Radius
See Note 2
Table 1

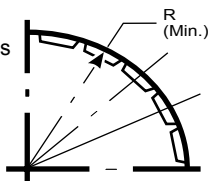

Sketch B:
Max. Component
Rotation - Front
Cross Sectional View

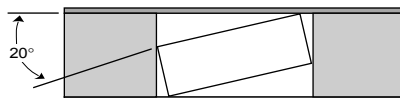

Sketch C:
Component Rotation - Top View

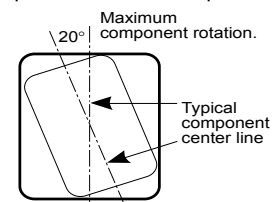

Bulk Cassette Packaging (Ceramic Chips only) (Meets Dimensional Requirements IEC-286-6 and EIAJ 7201)

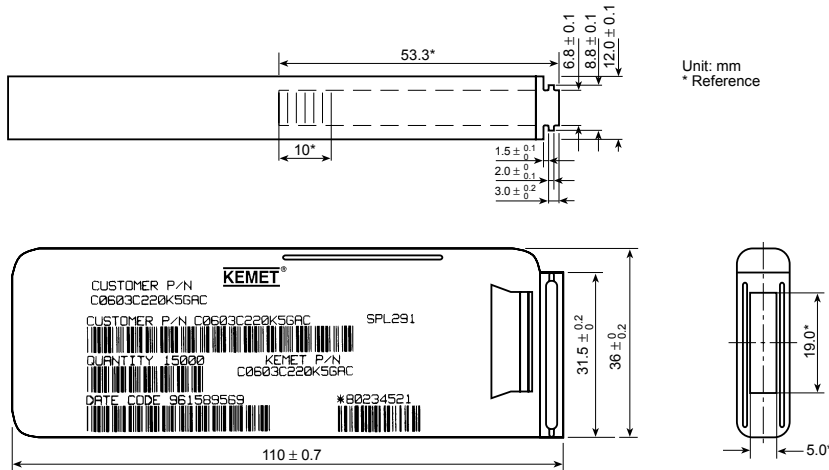

Table 2 – Capacitance Values Available In Bulk Cassette Packaging

Case Size	Dielectric	Voltage	Min. Cap Value	Max. Cap Value
0402	All	All	All	All
0603	All	All	All	All
0805	C0G	All	109	181
		100	109	331
		50	109	102
	X7R	200	221	392
		100	221	103
		50	221	273
		25	221	104
		16	221	104
	Y5V	25	104	224
		16	104	224

Table 1 – Capacitor Dimensions for Bulk Cassette Packaging – Millimeters

Metric Size Code	EIA Size Code	Length L	Width W	Thickness T	Bandwidth B	Minimum Separation S	Number of Pcs/Cassette
1005	0402	1.0 ± 0.05	0.5 ± 0.05	0.5 ± .05	0.2 to 0.4	0.3	50,000
1608	0603	1.6 ± 0.07	0.8 ± 0.07	0.8 ± .07	0.2 to 0.5	0.7	15,000
2012	0805	2.0 ± 0.10	1.25 ± 0.10	0.6 ± .10	0.5 to 0.75	0.75	10,000

Terminations: KEMET nickel barrier layer with a tin overplate.

CAPACITOR MARKING TABLE (Marking Optional - Not Available for 0402 Size or Y5V Dielectric)

Alpha Character	Capacitance (pF) For Various Numerical Identifiers						
	9	0	1	2	3	4	5
A	0.10	1.0	10	100	1000	10,000	100,000
B	0.11	1.1	11	110	1100	11,000	110,000
C	0.12	1.2	12	120	1200	12,000	120,000
D	0.13	1.3	13	130	1300	13,000	130,000
E	0.15	1.5	15	150	1500	15,000	150,000
F	0.16	1.6	16	160	1600	16,000	160,000
G	0.18	1.8	18	180	1800	18,000	180,000
H	0.20	2.0	20	200	2000	20,000	200,000
J	0.22	2.2	22	220	2200	22,000	220,000
K	0.24	2.4	24	240	2400	24,000	240,000
L	0.27	2.7	27	270	2700	27,000	270,000
M	0.30	3.0	30	300	3000	30,000	300,000
N	0.33	3.3	33	330	3300	33,000	330,000
P	0.36	3.6	36	360	3600	36,000	360,000
Q	0.39	3.9	39	390	3900	39,000	390,000
R	0.43	4.3	43	430	4300	43,000	430,000
S	0.47	4.7	47	470	4700	47,000	470,000
T	0.51	5.1	51	510	5100	51,000	510,000
U	0.56	5.6	56	560	5600	56,000	560,000
V	0.62	6.2	62	620	6200	62,000	620,000
W	0.68	6.8	68	680	6800	68,000	680,000
X	0.75	7.5	75	750	7500	75,000	750,000
Y	0.82	8.2	82	820	8200	82,000	820,000
Z	0.91	9.1	91	910	9100	91,000	910,000
a	0.25	2.5	25	250	2500	25,000	250,000
b	0.35	3.5	35	350	3500	35,000	350,000
d	0.40	4.0	40	400	4000	40,000	400,000
e	0.45	4.5	45	450	4500	45,000	450,000
f	0.50	5.0	50	500	5000	50,000	500,000
m	0.60	6.0	60	600	6000	60,000	600,000
n	0.70	7.0	70	700	7000	70,000	700,000
t	0.80	8.0	80	800	8000	80,000	800,000
y	0.90	9.0	90	900	9000	90,000	900,000

Laser marking is available as an extra-cost option for most KEMET ceramic chips. Such marking is two sided, and includes a \bar{K} to identify KEMET, followed by two characters (per EIA-198 - see table below) to identify the capacitance value. Note that marking is not available for size 0402 nor for any Y5V chip. In addition, the 0603 marking option is limited to the \bar{K} only.



Example shown is 1,000 pF capacitor.