

INTRODUCTION

Ceramic chips consist of formulated ceramic dielectric materials which have been fabricated into thin layers, interspersed with metal electrodes alternately exposed on opposite edges of the laminated structure. The entire structure is then fired at high temperature to produce a monolithic block which provides high capacitance values in a small physical volume. After firing, conductive terminations are applied to opposite ends of the chip to make contact with the exposed electrodes. Standard end terminations use a nickel barrier layer and a tin overplate to provide excellent solderability for the customer.

KEMET multilayer ceramic chip capacitors are produced in plants designed specifically for chip capacitor manufacture. The process features a high degree of mechanization as well as precise controls over raw materials and process conditions. Manufacturing is supplemented by extensive Technology, Engineering and Quality Assurance programs.

KEMET ceramic chip capacitors are offered in the five most popular temperature characteristics. These are designated by the Electronics Industries Association (EIA) as the ultra-stable C0G (also known as NP0, military version BP), the stable X7R (military BX or BR), the stable X5R, and the general purpose Z5U and Y5V. A wide range of sizes are available. KEMET multilayer ceramic chip capacitors are available in KEMET's tape and reel packaging, compatible with automatic placement equipment. Bulk cassette packaging is also available (0805,0603 and 0402 only) for those pick and place machines requiring its use.

ELECTRICAL CHARACTERISTICS

1. Working Voltage:

Refers to the maximum continuous DC working voltage permissible across the entire operating temperature range. The reliability of multilayer ceramic capacitors is not extremely sensitive to voltage, and brief applications of voltage above rated will not result in immediate failure. However, reliability will be degraded by sustained exposure to voltages above rated.

2. Temperature Characteristics:

Within the EIA classifications, various temperature characteristics are identified by a three-symbol code; for example: C0G, X7R, X5R, Z5U and Y5V.

For Class I temperature compensating dielectrics (includes C0G), the first symbol designates the significant figures of the temperature coefficient in PPM per degree Celsius, the second designates the multiplier to be applied, and the third designates the tolerance in PPM per degrees Celsius. EIA temperature characteristic codes for Class I dielectrics are shown in Table 1.

Table 1 – EIA Temperature Characteristic Codes for Class I Dielectrics

| Significant Figure of Temperature Coefficient | | Multiplier Applied to Temperature Coefficient | | Tolerance of Temperature Coefficient | |
|---|---------------|---|---------------|--------------------------------------|---------------|
| PPM per Degree C | Letter Symbol | Multiplier | Number Symbol | PPM per Degree C | Letter Symbol |
| 0.0 | C | -1 | 0 | ± 30 | G |
| 0.3 | B | -10 | 1 | ± 60 | H |
| 0.9 | A | -100 | 2 | ± 120 | J |
| 1.0 | M | -1000 | 3 | ± 250 | K |
| 1.5 | P | -10000 | 4 | ± 500 | L |

KEMET supplies the C0G characteristic.

For Class II and III dielectrics (including X7R, X5R, Z5U & Y5V), the first symbol indicates the lower limit of the operating temperature range, the second indicates the upper limit of the operating temperature range, and the third indicates the maximum capacitance change allowed over the operating temperature range. EIA type designation codes for Class II and III dielectrics are shown in Table 2.

Table 2 – EIA Temperature Characteristic Codes for Class II & III Dielectrics

| Low Temperature Rating | | High Temperature Rating | | Maximum Capacitance Shift | | |
|------------------------|---------------|-------------------------|---------------|---------------------------|---------------|-----------|
| Degree Celsius | Letter Symbol | Degree Celsius | Number Symbol | Percent | Letter Symbol | EIA Class |
| +10C | Z | +45C | 2 | ± 1.0% | A | II |
| -30C | Y | +65C | 4 | ± 1.5% | B | II |
| -55C | X | +85C | 5 | ± 2.2% | C | II |
| | | +105C | 6 | ± 3.3% | D | II |
| | | +125C | 7 | ± 4.7% | E | II |
| | | +150C | 8 | ± 7.5% | F | II |
| | | +200C | 9 | ± 10.0% | P | II |
| | | | | ± 15.0% | R | II |
| | | | | ± 22.0% | S | III |
| | | | | + 22/-33% | T | III |
| | | | | +22/-56% | U | III |
| | | | | +22/-82% | V | III |

KEMET supplies the X7R, X5R, Z5U and Y5V characteristics.

3. Capacitance Tolerance:

See tables on pages 73-76.

4. Capacitance:

Within specified tolerance when measured per Table 3.

The standard unit of capacitance is the farad. For practical capacitors, capacitance is usually expressed in microfarads (10^{-6} farad), nanofarads (10^{-9} farad), or picofarads (10^{-12} farad). Standard measurement conditions are listed in Table 3 - Specified Electrical Limits.

Like all other practical capacitors, multilayer ceramic capacitors also have resistance and inductance. A simplified schematic for the single frequency equivalent circuit is shown in Figure 1. At high frequency more complex models apply - see KEMET SPICE models at www.kemet.com for details.

Ceramic Surface Mount

Figure 1

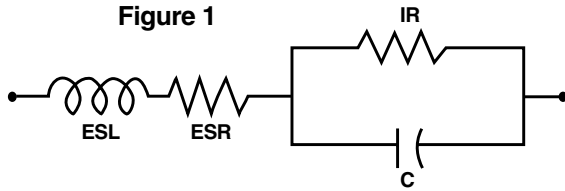

C = Capacitance
ESL = Equivalent Series Inductance
ESR = Equivalent Series Resistance
IR = Insulation Resistance

5. Dissipation Factor:
Measured under same conditions as capacitance. (See Table 3)

Dissipation factor (DF) is a measure of the losses in a capacitor under AC application. It is the ratio of the equivalent series resistance to the capacitive reactance, and is usually expressed in percent. It is normally measured simultaneously with capacitance, and under the same conditions. The vector diagram below illustrates the relationship between DF, ESR and impedance. The reciprocal of the dissipation factor is called the “Q” or quality factor. For convenience, the “Q” factor is often used for very low values of dissipation factor especially when measured at high frequencies. DF is sometimes called the “loss tangent” or “tangent δ”, as shown in Figure 2.

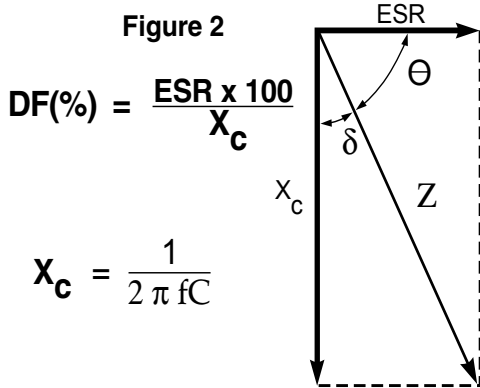

6. Impedance:

Since the parallel resistance (IR) is normally very high, the total impedance of the capacitor can be approximated by:

Figure 3

$$Z = \sqrt{ESR^2 + (X_L - X_C)^2}$$

Where: Z = Total Impedance

ESR = Equivalent Series Resistance

X_C = Capacitive Reactance = $1/(2 \pi f C)$

X_L = Inductive Reactance = $(2 \pi f) (ESL)$

The variation of a capacitor's impedance with frequency determines its effectiveness in many applications. At high frequency more detailed models apply - see KEMET SPICE models for such instances.

7. Insulation Resistance:

Measured after 2 minutes electrification at 25°C and rated voltage: Limits per Table 3.

Insulation Resistance is the measure of a capacitor to resist the flow of DC leakage current. It is sometimes referred to as “leakage resistance”. Insulation resistance (IR) is the DC resistance measured across the terminals of a capacitor, represented by the parallel resistance (IR) shown in Figure 1. For a given dielectric type, electrode area increases with capacitance, resulting in a decrease in the insulation resistance. Consequently, insulation resistance limits are usually specified as the “RC” (IR x C) product, in terms of ohm-farads or megohm-micro-farads. The insulation resistance for a specific capacitance value is determined by dividing this product by the capacitance. However, as the nominal capacitance values become small, the insulation resistance calculated from the RC product reaches values which are impractical. Consequently, IR specifications usually include both a minimum RC product and a maximum limit based on the IR calculated

Table 3 – Specified Electrical Limits

| Parameter | Temperature Characteristics | | | |
|--|--|---|--|---|
| | C0G | X7R/X5R | Z5U | Y5V |
| Capacitance & Dissipation Factor: Measured at following conditions: C0G – 1kHz and 1 vrms if capacitance >1000 pF 1MHz and 1 vrms if capacitance ≤1000 pF X7R/X5R/Y5V – 1kHz and 1 vrms* if capacitance ≤ 10 μF X7R/X5R/Y5V – 120Hz and 0.5 vrms if capacitance > 10 μF Z5U – 1kHz and 0.5 vrms | | | | |
| DF Limits: **X5R Cap DF 50 - 200 volts – <25V <564 5.0% 25 volts – <25V ≥564 10.0% 16 volts – 6.3/10 volts – | 0.10% 0.10% ----- ----- | 2.5% 2.5% 3.5% 5.0% 3.5% ** 5.0% ** | 4.0% 4.0% ----- | 5.0% 7.0% 7.0% 10.0% |
| Dielectric Strength: At 2.5 times rated DC voltage | Pass Subsequent IR Test | | | |
| Insulation Resistance (IR): At rated DC voltage, whichever of the two is smaller. To get IR limit, divide MΩ-μF value by the capacitance and compare to GΩ limit. Select the lower of the two limits. | 1,000 MΩ – μF or 100 GΩ (100,000 MΩ) | 1,000 MΩ – μF or 100 GΩ (100,000 MΩ) | 100 MΩ – μF or 10 GΩ (10,000 MΩ) | 100 MΩ – μF or 10 G (≥16 volt) 50 MΩ – μF or 10G (≤10v) (10,000 MΩ) |
| Temperature: Range, °C Capacitance Change (without DC voltage) | -55 to +125 0 ± 30 ppm/°C | X7R: -55 to +125 ±15% X5R: -55 to +85 ±15% | +10 to +85 +22% -56% | -30 to +85 +22% -82% |

*Note: Some values measured at ½ volt, see X7R Table for specific details on pages 74 and 75.

from that value. For example, a typical IR specification might read “1,000 megohm-microfarads or 100 gigohms, whichever is less”. The DC leakage current may be calculated by dividing the applied voltage by the insulation resistance (Ohm's Law).

8. Dielectric Withstanding Voltage:
250% of rated voltage for 5 seconds with current limited to 50mA at 25°C. Limits per Table 3.

Dielectric withstanding voltage (DWV) is the peak DC voltage which a capacitor is designed to withstand without damage for short periods of time. All KEMET multilayer ceramic surface mount capacitors will withstand a DC test voltage of 2.5 x the rated voltage for 60 seconds.

KEMET specification limits for all electrical characteristics at standard measurement conditions are shown in Table 3. Variations in these properties caused by changing conditions (temperature, voltage, frequency, and time) are covered in the following sections.

9. Aging Rate:
Maximum % Capacitance Loss/Decade Hour
C0G - 0%
X7R - 2.0%
X5R - 5.0%
Z5U - 7.0%
Y5V - 7.0%
Actual rates may be lower. Consult factory for details.

The capacitance of Class II and III dielectric changes with time as well as with temperature, voltage and frequency. The change with time is known as “aging”. It is caused by gradual realignment of the crystalline structure of the ceramic dielectric material as it is cooled below its Curie temperature, which produces a loss of capacitance with time. The aging process is predictable and follows a logarithmic decay.

The aging process is reversible. If the capacitor is heated to a temperature above its Curie point for some period of time, de-aging will occur and the capacitor will regain the capacitance lost during the aging process. The amount of de-aging depends on both the elevated temperature and the length of time at that temperature. Exposure to 150°C for one-half hour is sufficient to return the capacitor to its initial value.

Because the capacitance changes rapidly immediately after de-aging, capacitance measurements are usually delayed for at least 24-48 hours after the de-aging process, which is often referred to as the “last heat”. In addition, manufacturers utilize the aging rates to set factory test limits which will bring the capacitance within the specified tolerance at some future time, to allow for customer receipt and use.

10. Effect of Temperature:

Both capacitance and dissipation factor are affected by variations in temperature. The maximum capacitance change with temperature is defined by the temperature characteristic.

However, this only defines an “envelope” bounded by the upper and lower operating temperatures and the minimum and maximum capacitance values. Within this “envelope”, the variation with temperature depends upon the specific dielectric formulation.

Insulation resistance decreases with increasing temperature. Typically, the insulation resistance limit at maximum rated temperature is 10% of the 25°C value.

11. Effect of Voltage:

Certain high dielectric constant ceramic capacitors may show variation in values of capacitance and dissipation factor with various levels of applied AC and DC voltages. Such variation is a natural characteristic of ceramic capacitors, and should be considered by the circuit designer.

In general, ceramic capacitors with the lowest dielectric constant (C0G or NP0) are extremely stable, and show little or no variation in capacitance and/or dissipation factor. On the other hand, ceramic capacitors with the highest dielectric constant (Z5U & Y5V) may show significant variation, particularly in capacitance. Other dielectric formulations such as X7R and X5R will show less variation than Y5V, but more than C0G.

The application of AC voltages in the range of 10 to 20 VAC tends to increase the values of both the capacitance and dissipation factor, while higher AC voltages tend to produce decreases in both.

However, the variation of capacitance with applied DC is the parameter of most interest to design engineers. Figure 8 shows typical variation of capacitance with applied DC voltage for some standard dielectrics. As can be seen, the decrease in capacitance is greatest for the Y5V dielectric (the C0G is not plotted, since it would not have a perceptible capacitance nor dissipation factor change.)

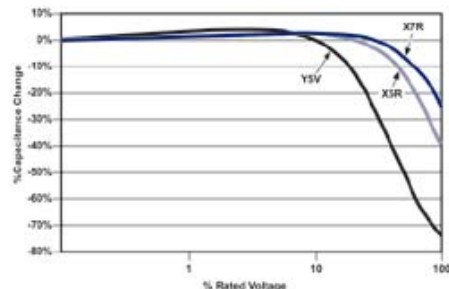

Figure 8 - Typical Variation of Capacitance with Applied DC Voltage (dissipation factor change.)

More detailed modelling information on the effect of various voltages on specific capacitor ratings can be obtained by use of the KEMET SPICE models, available for free downloading at our website (www.kemet.com).

12. Effect of Frequency:

Frequency affects both capacitance and dissipation factor. Typical curves for KEMET multilayer ceramic capacitors are shown in Figures 4, 5, 6 and 7.

The variation of impedance with frequency is an important consideration in the application of multilayer ceramic capacitors. Total impedance of the capacitor is

the vector summation of the capacitive reactance, the inductive reactance, and the ESR, as illustrated in Figure 2. As frequency increases, the capacitive reactance decreases. However, the series inductance (L) shown in Figure 1 produces some inductive reactance, which increases with frequency. At some frequency, the impedance ceases to be capacitive and becomes inductive. This point, at the bottom of the V-shaped impedance versus frequency curves, is the self-resonant frequency. At the self-resonant frequency, the reactance is zero, and the impedance consists of the ESR only. At high frequency more detailed models apply - See KEMET SPICE models for such instances.

Typical impedance versus frequency curves for KEMET multilayer ceramic capacitors are shown in Figures 4, 5, 6 and 7.

ENVIRONMENTAL AND PHYSICAL

- 13. **Thermal Shock:**
EIA-198, Method 202, Condition B (5 cycles -55° to + 125°C).
- 14. **Life Test:**
EIA-198, Method 201, 1000 hours at 200%* of rated voltage at 125°C. (Except 85°C for Z5U, Y5V & X5R).
See Table 4 on page 71 for limits.
*Note: 150% of rated voltage for selected high capacitance X5R values. Please contact factory.
- 15. **Humidity Test:**
EIA-198, Method 206, (Except 1000 hours,85°C, 85% RH, Rated Voltage).
See Table 4 on page 71 for limits.
- 16. **Moisture Resistance:**
EIA-198, Method 204, Condition B (20 cycles with 50 volts applied).
See Table 4 on page 71 for limits.
- 17. **Solderability:**
EIA-198, Method 301 (245°, 5 secs, Sn62 solder) 95% smooth solder on terminations. See page 14 for recommended profiles.
- 18. **Resistance to Soldering Heat:**
EIA-198, Method 302, Condition B (260°C, 10 seconds) no leaching of nickel barrier.
- 19. **Terminal Strength:**
EIA-198, Method 303, Condition D .

RELIABILITY

- 20. A well constructed multilayer ceramic capacitor chip is extremely reliable and, for all practical purposes, has no wearout mechanism when used within the maximum voltage and temperature ratings. Most failures occur as a result of mechanical or thermal damage during mounting on the board, or during subsequent testing. Capacitor failure may also be induced by sustained operation at voltages that exceed the rated DC voltage, voltage spikes or transients that exceed the dielectric's voltage capability, sustained operation at temperatures above the maximum rated temperature, internal defects, or excessive temperature rise due to power

dissipation. As with any practical device, multilayer ceramic capacitors also possess an inherent, although low, failure rate when operated within rated conditions. The primary failure mode is by short-circuit or low insulation resistance, resulting from cracks or from dielectric breakdown at a defect site. KEMET monitors reliability with a periodic sampling program for selected values. Results are available in our FIT (Failure in Time) report for commercial chips.

21. Storage and Handling:

Ceramic chip capacitors should be stored in normal working environments. While the chips themselves are quite robust in other environments, solderability will be degraded by exposure to high temperatures, high humidity, corrosive atmospheres, and long term storage. In addition, packaging materials will be degraded by high temperature – reels may soften or warp, and tape peel force may increase. KEMET recommends that maximum storage temperature not exceed 40 degrees C, and maximum storage humidity not exceed 70% relative humidity. In addition, temperature fluctuations should be minimized to avoid condensation on the parts, and atmospheres should be free of chlorine and sulfur bearing compounds. For optimized solderability, chip stock should be used promptly, preferably within 1.5 years of receipt.

MISAPPLICATION

- 22. Ceramic capacitors, like any other capacitors, may fail if they are misapplied. Some misapplications include mechanical damage, such as impact or excessive flexing of the circuit board. Others include severe mounting or rework cycles that may also introduce thermal shock. Still others include exposure to excessive voltage, current or temperature. If the dielectric layer of the capacitor is damaged by misapplication, the circuit may fail. The electrical energy of the circuit can be released as heat, which may damage the circuit board and other components as well.

ADDITIONAL INFORMATION

- 23. Detailed application information can be found in KEMET Engineering Bulletins.
 - F-2100 Surface Mount-Mounting Pad Dimensions and Considerations
 - F-2102 Reflow Soldering Process
 - F-2105 Wave Solder Process
 - F-2103 Surface Mount Repair
 - F-2110 Capacitance Monitoring while Flex Testing
 - F-2111 Ceramic Chip Capacitors "Flex Cracks" - Understanding and Solutions

For analysis of high frequency applications, KEMET has SPICE models of most chip capacitors. Models may be downloaded from KEMET's website www.kemet.com.

Additional information is also available - See your KEMET representative for details or post your questions to KEMET's homepage on the web <http://www.kemet.com>.

TABLE 4 – ENVIRONMENTAL LIMITS

| Body | Rated DC Voltage | Initial DF (%) | IR (GΩ or ΩF) whichever is less | DF (%) Post Life/ Hum/Moisture Resistance | Cap Shift (% or pf, whichever is greater) Post Life/ Hum/Moisture Resistance | IR (GΩ or ΩF) whichever is less Post Life/ Hum/Moisture Resistance |
|------|--------------------|----------------|---------------------------------|---|--|--|
| C0G | 200* | 0.1 | 100/1000 | 0.5 | 0.3% or ± 0.25 pf | 10/100 |
| | 100 | 0.1 | 100/1000 | 0.5 | 0.3% or ± 0.25 pf | 10/100 |
| | 50 | 0.1 | 100/1000 | 0.5 | 0.3% or ± 0.25 pf | 10/100 |
| | 25 | 0.1 | 100/1000 | 0.5 | 0.3% or ± 0.25 pf | 10/100 |
| | 16 | 0.1 | 100/1000 | 0.5 | 0.3% or ± 0.25 pf | 10/100 |
| X7R | 200* | 2.5 | 100/1000 | 3.0 | ± 20% | 10/100 |
| | 100 | 2.5 | 100/1000 | 3.0 | ± 20% | 10/100 |
| | 50 | 2.5 | 100/1000 | 3.0 | ± 20% | 10/100 |
| | 25 | 3.5 | 100/1000 | 5.0 | ± 20% | 10/100 |
| | 16 | 3.5 | 100/1000 | 5.0 | ± 20% | 10/100 |
| | 6.3/10 | 5.0 | 100/1000 | 7.5 | ± 20% | 10/100 |
| X5R | 50V all cap values | 2.5 | 100/1000 | 3.0 | ± 20% | 10/100 |
| | 25V all cap values | 5.0 | 100/1000 | 7.5 | ± 20% | 10/100 |
| | <25≤564 cap value | 5.0 | 100/1000 | 7.5 | ± 20% | 10/100 |
| | >564 cap value | 10.0 | 100/1000 | 12.0 | ± 20% | 10/100 |
| Z5U | 100 | 4.0 | 10/100 | 5.0 | ± 30% | 1/10 |
| | 50 | 4.0 | 10/100 | 5.0 | ± 30% | 1/10 |
| | 25 | 4.0 | 10/100 | 7.5 | ± 30% | 1/10 |
| Y5V | 100 | 5.0 | 10/100 | 7.5 | ± 30% | 1/10 |
| | 50 | 5.0 | 10/100 | 7.5 | ± 30% | 1/10 |
| | 25 | 7.0 | 10/100 | 10.0 | ± 30% | 1/10 |
| | 16 | 7.0 | 10/100 | 10.0 | ± 30% | 1/10 |
| | 6.3/10 | 10.0 | 10/50 | 15.0 | ± 30% | 1/5 |

*200 Volt limits not currently included in EIA-198.

PERFORMANCE CURVES EFFECT OF FREQUENCY (See SPICE models for specific ratings.)

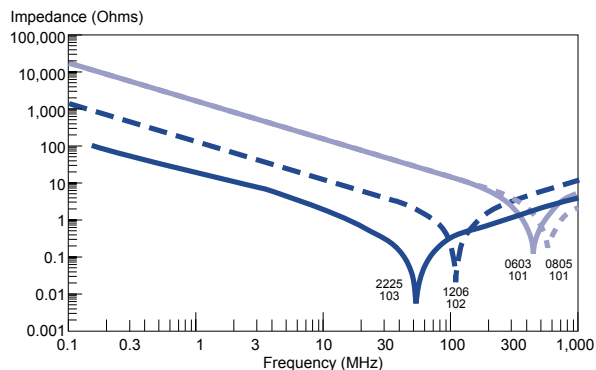

FIGURE 4. Impedance versus Frequency C0G Dielectric

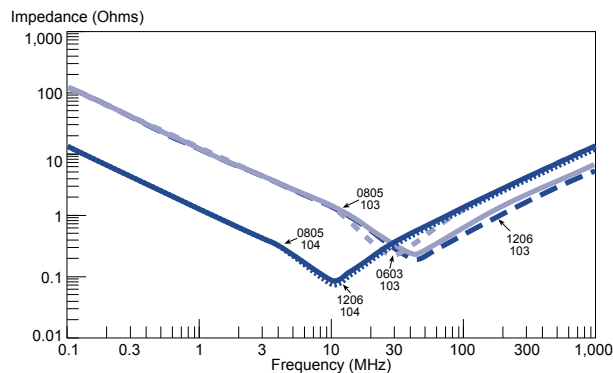

FIGURE 5. Impedance versus Frequency X7R Dielectric

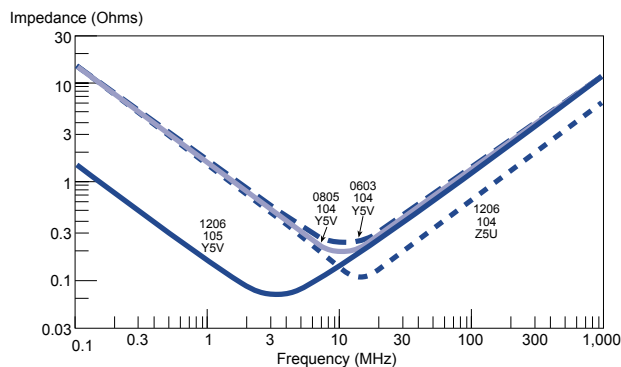

FIGURE 6. Impedance versus Frequency Z5U/Y5V Dielectric

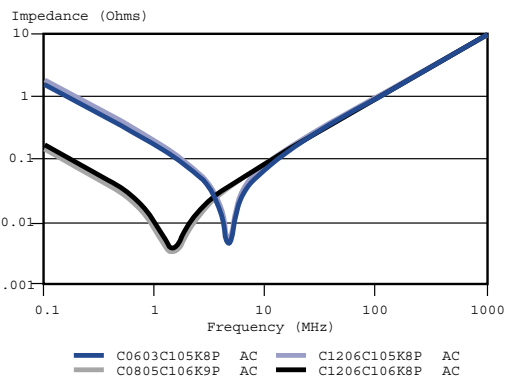

FIGURE 7. Impedance versus Frequency X5R Dielectric

Ceramic Surface Mount

FEATURES

- C0G (NP0), X7R, X5R, Z5U and Y5V Dielectrics
- 10, 16, 25, 50, 100 and 200 Volts
- Standard End Metallization: Tin-plate over nickel barrier
- Available Capacitance Tolerances: ± 0.10 pF; ± 0.25 pF; ± 0.5 pF; $\pm 1\%$; $\pm 2\%$; $\pm 5\%$; $\pm 10\%$; $\pm 20\%$; and $+80\%$ - 20%
- Tape and reel packaging per EIA481-1. (See page 92 for specific tape and reel information.) Bulk Cassette packaging (0402, 0603, 0805 only) per IEC60286-6 and EIAJ 7201.
- RoHS Compliant

CAPACITOR OUTLINE DRAWINGS

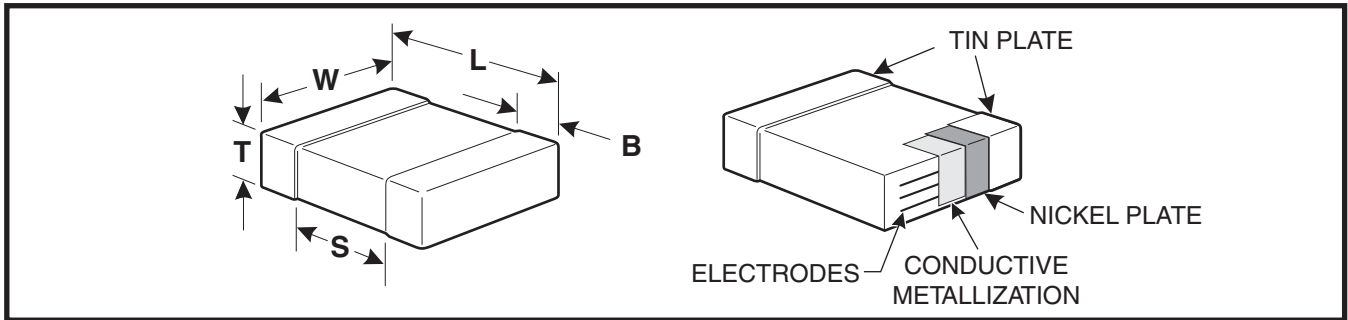

DIMENSIONS—MILLIMETERS AND (INCHES)

| EIA SIZE CODE | METRIC SIZE CODE | L - LENGTH | W - WIDTH | T THICKNESS | B - BANDWIDTH | S SEPARATION minimum | MOUNTING TECHNIQUE |
|---------------|------------------|-----------------------------|-----------------------------------|---------------------------------------|------------------------------|----------------------|--------------------------------------|
| 0201* | 0603 | 0.6 (.024) \pm .03 (.001) | 0.3 \pm (.012) \pm .03 (.001) | See page 78 for thickness dimensions. | 0.15 (.006) \pm .05 (.002) | N/A | Solder Reflow |
| 0402* | 1005 | 1.0 (.04) \pm .05 (.002) | 0.5 (.02) \pm .05 (.002) | | 0.20 (.008) - .40 (.016) | 0.3 (.012) | |
| 0603 | 1608 | 1.6 (.063) \pm .15 (.006) | 0.8 (.032) \pm .15 (.006) | | 0.35 (.014) \pm .15 (.006) | 0.7 (.028) | Solder Wave + or Solder Reflow |
| 0805* | 2012 | 2.0 (.079) \pm .20 (.008) | 1.25 (.049) \pm .20 (.008) | | 0.50 (.02) \pm .25 (.010) | 0.75 (.030) | |
| 1206* | 3216 | 3.2 (.126) \pm .20 (.008) | 1.6 (.063) \pm .20 (.008) | | 0.50 (.02) \pm .25 (.010) | N/A | |
| 1210* | 3225 | 3.2 (.126) \pm .20 (.008) | 2.5 (.098) \pm .20 (.008) | | 0.50 (.02) \pm .25 (.010) | N/A | Solder Reflow |
| 1812 | 4532 | 4.5 (.177) \pm .30 (.012) | 3.2 (.126) \pm .30 (.012) | | 0.60 (.024) \pm .35 (.014) | N/A | |
| 1825* | 4564 | 4.5 (.177) \pm .30 (.012) | 6.4 (.252) \pm .40 (.016) | | 0.60 (.024) \pm .35 (.014) | N/A | |
| 2220 | 5650 | 5.6 (.220) \pm .40 (.016) | 5.0 (.197) \pm .40 (.016) | | 0.60 (.024) \pm .35 (.014) | N/A | |
| 2225 | 5664 | 5.6 (.220) \pm .40 (.016) | 6.3 (.248) \pm .40 (.016) | | 0.60 (.024) \pm .35 (.014) | N/A | |

* Note: Indicates EIA Preferred Case Sizes (Tightened tolerances apply for 0402, 0603, and 0805 packaged in bulk cassette, see page 96.)

+ For extended value 1210 case size - solder reflow only.

CAPACITOR ORDERING INFORMATION (Standard Chips - For Military see page 87)

CERAMIC SIZE CODE SPECIFICATION
C - Standard

CAPACITANCE CODE
Expressed in Picofarads (pF)
First two digits represent significant figures.
Third digit specifies number of zeros. (Use 9 for 1.0 through 9.9pF. Use 8 for 0.5 through 0.99pF)
(Example: 2.2pF = 229 or 0.50 pF = 508)

CAPACITANCE TOLERANCE
B - ± 0.10 pF J - $\pm 5\%$
C - ± 0.25 pF K - $\pm 10\%$
D - ± 0.5 pF M - $\pm 20\%$
F - $\pm 1\%$ P - (GMV) - special order only
G - $\pm 2\%$ Z - $+80\%$, -20%

END METALLIZATION
C-Standard (Tin-plated nickel barrier)

FAILURE RATE LEVEL
A- Not Applicable

TEMPERATURE CHARACTERISTIC
Designated by Capacitance Change Over Temperature Range
G - C0G (NP0) (± 30 PPM/ $^{\circ}$ C)
R - X7R ($\pm 15\%$) (-55° C + 125° C)
P - X5R ($\pm 15\%$) (-55° C + 85° C)
U - Z5U ($+22\%$, -56%) ($+10^{\circ}$ C + 85° C)
V - Y5V ($+22\%$, -82%) (-30° C + 85° C)

VOLTAGE
1 - 100V 3 - 25V
2 - 200V 4 - 16V
5 - 50V 8 - 10V
7 - 4V 9 - 6.3V

* Part Number Example: C0805C103K5RAC (14 digits - no spaces)

C0G CAPACITANCE RANGE – 1210, 1812, 1825, 2220, 2225

| Cap pF | Cap Code | Cap Tolerance | C1210* | | | | C1812* | | | C1825* | | | C2220 | | | C2225 | | |
|-----------|-------------|------------------|--------|-----|------|------|--------|------|------|--------|------|------|-------|------|------|-------|------|------|
| | | | 25V | 50V | 100V | 200V | 50V | 100V | 200V | 50V | 100V | 200V | 50V | 100V | 200V | 50V | 100V | 200V |
| 10.0 | 100 | D J,K,M | FB | FB | FB | | | | | | | | | | | | | |
| 12.0 | 120 | D J,K,M | FB | FB | FB | | | | | | | | | | | | | |
| 15.0 | 150 | D G,J,K,M | FB | FB | FB | | | | | | | | | | | | | |
| 18.0 | 180 | D G,J,K,M | FB | FB | FB | | | | | | | | | | | | | |
| 22.0 | 220 | D G,J,K,M | FB | FB | FB | | | | | | | | | | | | | |
| 27.0 | 270 | D,F,G,J,K,M | FB | FB | FB | | | | | | | | | | | | | |
| 33.0 | 330 | D,F,G,J,K,M | FB | FB | FB | | | | | | | | | | | | | |
| 39.0 | 390 | D,F,G,J,K,M | FB | FB | FB | | | | | | | | | | | | | |
| 47.0 | 470 | D,F,G,J,K,M | FB | FB | FB | | | | | | | | | | | | | |
| 56.0 | 560 | F,G,J,K,M | FB | FB | FB | | | | | | | | | | | | | |
| 68.0 | 680 | F,G,J,K,M | FB | FB | FB | | | | | | | | | | | | | |
| 82.0 | 820 | F,G,J,K,M | FB | FB | FB | | | | | | | | | | | | | |
| 100.0 | 101 | F,G,J,K,M | FB | FB | FB | | | | | | | | | | | | | |
| 120.0 | 121 | F,G,J,K,M | FB | FB | FB | | | | | | | | | | | | | |
| 150.0 | 151 | F,G,J,K,M | FB | FB | FB | | | | | | | | | | | | | |
| 180.0 | 181 | F,G,J,K,M | FB | FB | FB | | | | | | | | | | | | | |
| 220.0 | 221 | F,G,J,K,M | FB | FB | FB | | | | | | | | | | | | | |
| 270.0 | 271 | F,G,J,K,M | FB | FB | FB | | | | | | | | | | | | | |
| 330.0 | 331 | F,G,J,K,M | FB | FB | FB | | | | | | | | | | | | | |
| 390.0 | 391 | F,G,J,K,M | FB | FB | FB | | | | | | | | | | | | | |
| 470.0 | 471 | F,G,J,K,M | FB | FB | FB | | | | GB | GB | GB | | | | | | | |
| 560.0 | 561 | F,G,J,K,M | FB | FB | FB | | | | GB | GB | GB | | | | | | | |
| 680.0 | 681 | F,G,J,K,M | FB | FB | FB | | | | GB | GB | GB | | | | | | | |
| 820.0 | 821 | F,G,J,K,M | FB | FB | FB | | | | GB | GB | GB | | | | | | | |
| 1,000.0 | 102 | F,G,J,K,M | FB | FB | FB | | | | GB | GB | GB | | | | | | | |
| 1,200.0 | 122 | F,G,J,K,M | FB | FB | FB | | | | GB | GB | GB | | | | | | | |
| 1,500.0 | 152 | F,G,J,K,M | FB | FB | FE | | | | GB | GB | GB | | | | | | | |
| 1,800.0 | 182 | F,G,J,K,M | FB | FB | FE | | | | GB | GB | GB | | | | | | | |
| 2,200.0 | 222 | F,G,J,K,M | FB | FC | FG | | | | GB | GB | GB | | | | | | | |
| 2,700.0 | 272 | F,G,J,K,M | FB | FC | FG | | | | GB | GB | GB | | | | | | | |
| 3,300.0 | 332 | F,G,J,K,M | FB | FF | FF | | | | GB | GB | GB | | | | | | | |
| 3,900.0 | 392 | F,G,J,K,M | FB | FF | FF | | | | GB | GB | GB | HB | HB | HB | | | | |
| 4,700.0 | 472 | F,G,J,K,M | FF | FG | GH | | | | GB | GB | GD | HB | HB | HB | | | | |
| 5,600.0 | 562 | F,G,J,K,M | FB | FG | GH | | | | GB | GB | GH | HB | HB | HB | | | | |
| 6,800.0 | 682 | F,G,J,K,M | FB | FG | GH | | | | GB | GB | GJ | HB | HB | HB | JB | JB | KB | |
| 8,200.0 | 822 | F,G,J,K,M | FC | FF | | | | | GB | GB | | HB | HB | HE | JB | JB | KB | |
| 10,000.0 | 103 | F,G,J,K,M | FF | | | | | | GB | GH | | HB | HB | HE | JB | JB | KB | |
| 12,000.0 | 123 | F,G,J,K,M | FG | | | | | | GB | GG | | HB | HB | HE | JB | JB | KB | |
| 15,000.0 | 153 | F,G,J,K,M | | | | | | | GB | | | HB | HB | HE | JB | JB | KB | |
| 18,000.0 | 183 | F,G,J,K,M | | | | | | | HB | HB | | HB | HB | HE | JB | JB | KB | |
| 22,000.0 | 223 | F,G,J,K,M | FB | | | | | | HB | HE | | JB | JB | | | | KB | |
| 27,000.0 | 273 | F,G,J,K,M | FB | | | | | | HB | HE | | JB | | | | | KB | |
| 33,000.0 | 333 | F,G,J,K,M | FB | | | | | | | | | | | | | | | |
| 47,000.0 | 473 | F,G,J,K,M | FB | | | | | | | | | | | | | | | |
| 68,000.0 | 683 | F,G,J,K,M | FB | | | | | | | | | | | | | | | |
| 100,000.0 | 104 | F,G,J,K,M | FE | | | | | | | | | | | | | | | |
| 220,000.0 | 224 | F,G,J,K,M | FK+ | | | | | | | | | | | | | | | |

X7R CAPACITANCE RANGE – 0402, 0603, 0805, 1206

| Cap pF | Cap Code | Cap Tolerance | C0402 | | | | | C0603 | | | | | C0805 | | | | | C1206 | | | | | | | | | | |
|-----------|-------------|------------------|-------|-----|-----|-----|-----|-------|-----|-----|-----|-----|-------|------|------|-----|-----|-------|-----|------|------|------|-----|-----|-----|-----|------|------|
| | | | 6.3V | 10V | 16V | 25V | 50V | 6.3V | 10V | 16V | 25V | 50V | 100V | 200V | 6.3V | 10V | 16V | 25V | 50V | 100V | 200V | 6.3V | 10V | 16V | 25V | 50V | 100V | 200V |
| 150 | 151 | K,M,J | BB | BB | BB | BB | BB | CB | CB | CB | CB | CB | CB | CB | DC | DC | DC | DC | DC | DC | DC | | | | | | | |
| 180 | 181 | K,M,J | BB | BB | BB | BB | BB | CB | CB | CB | CB | CB | CB | DC | DC | DC | DC | DC | DC | DC | DC | | | | | | | |
| 220 | 221 | K,M,J | BB | BB | BB | BB | BB | CB | CB | CB | CB | CB | CB | DC | DC | DC | DC | DC | DC | DC | DC | | | | | | | |
| 270 | 271 | K,M,J | BB | BB | BB | BB | BB | CB | CB | CB | CB | CB | CB | DC | DC | DC | DC | DC | DC | DC | DC | | | | | | | |
| 330 | 331 | K,M,J | BB | BB | BB | BB | BB | CB | CB | CB | CB | CB | CB | DC | DC | DC | DC | DC | DC | DC | DC | | | | | | | |
| 390 | 391 | K,M,J | BB | BB | BB | BB | BB | CB | CB | CB | CB | CB | CB | DC | DC | DC | DC | DC | DC | DC | DC | | | | | | | |
| 470 | 471 | K,M,J | BB | BB | BB | BB | BB | CB | CB | CB | CB | CB | CB | DC | DC | DC | DC | DC | DC | DC | DC | | | | | | | |
| 560 | 561 | K,M,J | BB | BB | BB | BB | BB | CB | CB | CB | CB | CB | CB | DC | DC | DC | DC | DC | DC | DC | DC | | | | | | | |
| 680 | 681 | K,M,J | BB | BB | BB | BB | BB | CB | CB | CB | CB | CB | CB | DC | DC | DC | DC | DC | DC | DC | DC | | | | | | | |
| 820 | 821 | K,M,J | BB | BB | BB | BB | BB | CB | CB | CB | CB | CB | CB | DC | DC | DC | DC | DC | DC | DC | DC | | | | | | | |
| 1,000 | 102 | K,M,J | BB | BB | BB | BB | BB | CB | CB | CB | CB | CB | CB | DC | DC | DC | DC | DC | DC | DC | DC | EB | EB | EB | EB | EB | EB | EB |
| 1,200 | 122 | K,M,J | BB | BB | BB | BB | BB | CB | CB | CB | CB | CB | CB | CC | DC | DC | DC | DC | DC | DC | DC | EB | EB | EB | EB | EB | EB | EB |
| 1,500 | 152 | K,M,J | BB | BB | BB | BB | BB | CB | CB | CB | CB | CB | CB | CC | DC | DC | DC | DC | DC | DC | DC | EB | EB | EB | EB | EB | EB | EB |
| 1,800 | 182 | K,M,J | BB | BB | BB | BB | BB | CB | CB | CB | CB | CB | CB | CC | DC | DC | DC | DC | DC | DC | DC | EB | EB | EB | EB | EB | EB | EB |
| 2,200 | 222 | K,M,J | BB | BB | BB | BB | BB | CB | CB | CB | CB | CB | CB | CC | DC | DC | DC | DC | DC | DC | DC | EB | EB | EB | EB | EB | EB | EB |
| 2,700 | 272 | K,M,J | BB | BB | BB | BB | BB | CB | CB | CB | CB | CB | CB | CC | DC | DC | DC | DC | DC | DC | DC | EB | EB | EB | EB | EB | EB | EB |
| 3,300 | 332 | K,M,J | BB | BB | BB | BB | BB | CB | CB | CB | CB | CB | CB | CC | DC | DC | DC | DC | DC | DC | DC | EB | EB | EB | EB | EB | EB | EB |
| 3,900 | 392 | K,M,J | BB | BB | BB | BB | BB | CB | CB | CB | CB | CB | CB | CC | DC | DC | DC | DC | DC | DC | DC | EB | EB | EB | EB | EB | EB | EB |
| 4,700 | 472 | K,M,J | BB | BB | BB | BB | BB | CB | CB | CB | CB | CB | CB | CC | DC | DC | DC | DC | DC | DC | DC | EB | EB | EB | EB | EB | EB | EB |
| 5,600 | 562 | K,M,J | BB | BB | BB | BB | BB | CB | CB | CB | CB | CB | CB | CC | DC | DC | DC | DC | DC | DC | DC | EB | EB | EB | EB | EB | EB | EB |
| 6,800 | 682 | K,M,J | BB | BB | BB | BB | BB | CB | CB | CB | CB | CB | CB | CC | DC | DC | DC | DC | DC | DC | DC | EB | EB | EB | EB | EB | EB | EB |
| 8,200 | 822 | K,M,J | BB | BB | BB | BB | BB | CB | CB | CB | CB | CB | CB | CC | DC | DC | DC | DC | DC | DC | DC | EB | EB | EB | EB | EB | EB | EB |
| 10,000 | 103 | K,M,J | BB | BB | BB | BB | BB | CB | CB | CB | CB | CB | CB | CC | DC | DC | DC | DC | DC | DC | DC | EB | EB | EB | EB | EB | EB | EB |
| 12,000 | 123 | K,M,J** | BB | BB | BB | BB | BB | CB | CB | CB | CB | CB | CB | CC | DC | DC | DC | DC | DC | DC | DC | EB | EB | EB | EB | EB | EB | EB |
| 15,000 | 153 | K,M,J** | BB | BB | BB | BB | BB | CB | CB | CB | CB | CB | CB | CC | DC | DC | DC | DC | DC | DC | DC | EB | EB | EB | EB | EB | EB | EB |
| 18,000 | 183 | K,M,J** | BB | BB | BB | BB | BB | CB | CB | CB | CB | CB | CB | CC | DC | DC | DC | DC | DC | DC | DC | EB | EB | EB | EB | EB | EB | EB |
| 22,000 | 223 | K,M,J** | BB | BB | BB | BB | BB | CB | CB | CB | CB | CB | CB | CC | DC | DC | DC | DC | DC | DC | DC | EB | EB | EB | EB | EB | EB | EB |
| 27,000 | 273 | K,M,J** | BB | BB | BB | BB | BB | CB | CB | CB | CB | CB | CB | CC | DC | DC | DC | DC | DC | DC | DC | EB | EB | EB | EB | EB | EB | EB |
| 33,000 | 333 | K,M,J** | BB | BB | BB | BB | BB | CB | CB | CB | CB | CB | CB | CC | DC | DC | DC | DC | DC | DC | DC | EB | EB | EB | EB | EB | EB | EB |
| 39,000 | 393 | K,M,J** | BB | BB | BB | BB | BB | CB | CB | CB | CB | CB | CB | CC | DC | DC | DC | DC | DC | DC | DC | EB | EB | EB | EB | EB | EB | EB |
| 47,000 | 473 | K,M,J** | BB | BB | BB | BB | BB | CB | CB | CB | CB | CB | CB | CC | DC | DC | DC | DC | DC | DC | DC | EB | EB | EB | EB | EB | EB | EB |
| 56,000 | 563 | K,M,J** | BB | BB | BB | BB | BB | CB | CB | CB | CB | CB | CB | CC | DC | DC | DC | DC | DC | DC | DC | EB | EB | EB | EB | EB | EB | EB |
| 68,000 | 683 | K,M,J** | BB | BB | BB | BB | BB | CB | CB | CB | CB | CB | CB | CC | DC | DC | DC | DC | DC | DC | DC | EB | EB | EB | EB | EB | EB | EB |
| 82,000 | 823 | K,M,J** | BB | BB | BB | BB | BB | CB | CB | CB | CB | CB | CB | CC | DC | DC | DC | DC | DC | DC | DC | EB | EB | EB | EB | EB | EB | EB |
| 100,000 | 104 | K,M,J** | BB | BB | BB | BB | BB | CB | CB | CB | CB | CB | CB | CC | DC | DC | DC | DC | DC | DC | DC | EB | EB | EB | EB | EB | EB | EB |
| 120,000 | 124 | K,M,J** | | | | | | CB | CB | CB | | | | | DD | DC | DC | DC | DC | DD | DG | EC | EC | EC | EC | EC | EC | EM |
| 150,000 | 154 | K,M,J** | </ | | | | | | | | | | | | | | | | | | | | | | | | | |

X5R CAPACITANCE RANGE

| Cap pF | Cap Code | Cap Tolerance | 0201 | | C0402* | | | C0603* | | | | C0805* | | | | C1206* | | | | C1210* | | | | | | | |
|-------------|----------|---------------|------|-----|--------|-----|-----|--------|-----|-----|-----|--------|------|------|-----|--------|------|-----|-----|--------|------|-----|-----|-----|-----|-----|------|
| | | | 6.3V | 16V | 6.3V | 10V | 16V | 6.3V | 10V | 16V | 25V | 4V | 6.3V | 10V | 16V | 25V | 6.3V | 10V | 16V | 25V | 6.3V | 10V | 16V | 25V | 50V | | |
| 10,000 | 103 | K,M | | AA~ | | | | | | | | | | | | | | | | | | | | | | | |
| 12,000 | 123 | K,M | | | BB | BB | BB | | | | | | | | | | | | | | | | | | | | |
| 15,000 | 153 | K,M | | | BB | BB | BB | | | | | | | | | | | | | | | | | | | | |
| 18,000 | 183 | K,M | | | BB | BB | BB | | | | | | | | | | | | | | | | | | | | |
| 22,000 | 223 | K,M | | | BB | BB | BB | | | | | | | | | | | | | | | | | | | | |
| 27,000 | 273 | K,M | | | BB | BB | BB | | | | | | | | | | | | | | | | | | | | |
| 33,000 | 333 | K,M | | | BB | BB | BB | | | | | | | | | | | | | | | | | | | | |
| 39,000 | 393 | K,M | | | BB | BB | BB | | | | | | | | | | | | | | | | | | | | |
| 47,000 | 473 | K,M | | | BB | BB | BB | | | | | | | | | | | | | | | | | | | | |
| 56,000 | 563 | K,M | | | BB | BB | BB | | | | | | | | | | | | | | | | | | | | |
| 68,000 | 683 | K,M | | | BB | BB | BB | | | | | | | | | | | | | | | | | | | | |
| 82,000 | 823 | K,M | | | BB | BB | BB | | | | | | | | | | | | | | | | | | | | |
| 100,000 | 104 | K,M | | AA~ | BB | BB | BB | | | | | | | | | | | | | | | | | | | | |
| 120,000 | 124 | K,M | | | | | | | | | | | | | | | | | | | | | | | | | |
| 150,000 | 154 | K,M | | | | | | | | | | | | | | | | | | | | | | | | | |
| 180,000 | 184 | K,M | | | | | | | | | | | | | | | | | | | | | | | | | |
| 220,000 | 224 | K,M | | | BB | | | | | | | | | | | | | | | | | | | | | | |
| 270,000 | 274 | K,M | | | | | | CC | CC | CC | CC | | | | | | | | | | | | EB | | | | |
| 330,000 | 334 | K,M | | | | | | CC | CC | CC | CC | | | | | | | | | | | | EB | | | | |
| 390,000 | 394 | K,M | | | | | | CC | CC | CC | CC | | | | | | | | | | | | EB | | | | |
| 470,000 | 474 | K,M | | | | | | CC | CC | CC | CC | | | | | | | | | | | | EB | | | | |
| 560,000 | 564 | K,M | | | | | | CC | CC | CC | CC | | | | | | | | | | | | ED | | | | |
| 680,000 | 684 | K,M | | | | | | CC | CC | CC | CC | | | | | | | | | | | | ED | | | | |
| 820,000 | 824 | K,M | | | | | | CC | CC | CC | CC | | | | | | | | | | | | EE | | | | |
| 1,000,000 | 105 | K,M | | | BB | BB | | CC | CC | CC | CC | | | | | | | | | | | | EF | | | | |
| 1,200,000 | 125 | K,M | | | | | | | | | CD | | | | | | | | | | | | EH | | | FH+ | |
| 1,500,000 | 155 | K,M | | | | | | | | | | | DG | DG | DG | DG | | | | | | | EH | | | FH+ | |
| 1,800,000 | 185 | K,M | | | | | | | | | | | DE | DE | DE | DE | | | | | | | EC | EC | EC | EC | FD+ |
| 2,200,000 | 225 | K,M | | | | | | | | | | | DH | DH | DH | DH | | | | | | | EC | EC | EC | EC | FD+ |
| 2,700,000 | 275 | K,M | | | BB° | | | CC+ | CC+ | CC+ | | | DD | DG | DD | | | | | | | | EE | EE | EE | EE | FD+ |
| 3,300,000 | 335 | K,M | | | | | | | | | | | DD | DG | DD | | | | | | | | EF | EF | EF | EF | FG+ |
| 4,700,000 | 475 | K,M | | | | | | CD+ | | | | | DE | DE | DH | | | | | | | | EH | EH | EH | EH | FG+ |
| 5,600,000 | 565 | K,M | | | | | | | | | | | DH | DH | DH | | | | | | | | EH | EH | EH | EH | FG+ |
| 6,800,000 | 685 | K,M | | | | | | | | | | | | | | | | | | | | | ED | ED | ED | ED | FK+ |
| 8,200,000 | 825 | K,M | | | | | | | | | | | | | | | | | | | | | ED | ED | ED | ED | FK+ |
| 10,000,000 | 106 | K,M | | | | | | CD°+ | | | | | DJ+ | DJ+ | DK+ | | | | | | | | EH | EH | EH | EH | FK+ |
| 12,000,000 | 126 | K,M | | | | | | | | | | | | | | | | | | | | | | | | | FK+ |
| 15,000,000 | 156 | K,M | | | | | | | | | | | | | | | | | | | | | | | | | FK+ |
| 18,000,000 | 186 | K,M | | | | | | | | | | | | | | | | | | | | | | | | | FK+ |
| 22,000,000 | 226 | K,M | | | | | | | | | | | | DH°+ | | | | | | | | | | | | | FK+ |
| 27,000,000 | 276 | K,M | | | | | | | | | | | | | | | | | | | | | | | | | FK+ |
| 33,000,000 | 336 | K,M | | | | | | | | | | | | | | | | | | | | | | | | | FK+ |
| 39,000,000 | 396 | K,M | | | | | | | | | | | | | | | | | | | | | | | | | FK+ |
| 47,000,000 | 476 | K,M | | | | | | | | | | | | | | | | | | | | | | | | | FK+ |
| 100,000,000 | 107 | K,M | | | | | | | | | | | | DJ°+ | | | | | | | | | | | | | FK°+ |
| | | | | | | | | | | | | | | | | | | | | | | | | | | | FK°+ |

NOTE: For non-standard capacitance values or voltages, contact your local KEMET sales representative.

+Reflow only ° Available M ±20% tolerance only

Improved product with higher ratings and tighter capacitance tolerance product may be substituted within the same size (length, width, and thickness) at KEMET's option. Reels with such substitutions will be marked with the improved KEMET part numbers.

Z5U CAPACITANCE RANGE

(KEMET's Z5U also meets Y5V Characteristics)

| Cap pF | Cap Code | Cap Tol. | C0805* | | C1206* | | C1210* | | C1812* | | C1825* | | C2225 | |
|-----------|----------|----------|--------|------|--------|------|--------|------|--------|------|--------|------|-------|------|
| | | | 50V | 100V | 50V | 100V | 50V | 100V | 50V | 100V | 50V | 100V | 50V | 100V |
| 6,800 | 682 | M,Z | DC | DC | | | | | | | | | | |
| 8,200 | 822 | M,Z | DC | DC | | | | | | | | | | |
| 10,000 | 103 | M,Z | DC | DC | EB | EB | | | | | | | | |
| 12,000 | 123 | M,Z | DC | DC | EB | EB | | | | | | | | |
| 15,000 | 153 | M,Z | DC | DC | EB | EB | | | | | | | | |
| 18,000 | 183 | M,Z | DC | DC | EB | EB | | | | | | | | |
| 22,000 | 223 | M,Z | DC | DC | EB | EB | | | | | | | | |
| 27,000 | 273 | M,Z | DC | DC | EB | EB | | | | | | | | |
| 33,000 | 333 | M,Z | DC | DC | EB | EB | | | | | | | | |
| 39,000 | 393 | M,Z | DD | DD | EB | EC | | | | | | | | |
| 47,000 | 473 | M,Z | DD | DD | EB | EC | FB | FB | | | | | | |
| 56,000 | 563 | M,Z | DD | DD | EB | EB | FB | FB | | | | | | |
| 68,000 | 683 | M,Z | DD | DD | EB | EB | FB | FB | | | | | | |
| 82,000 | 823 | M,Z | DD | DD | EB | EB | FB | FC | GB | GB | | | | |
| 100,000 | 104 | M,Z | DD | DD | EB | EB | FB | FD | GB | GB | | | | |
| 120,000 | 124 | M,Z | | | EC | FC | FB | FD | GB | GB | | | | |
| 150,000 | 154 | M,Z | | | EC | FC | FC | FD | GB | GB | | | | |
| 180,000 | 184 | M,Z | | | EC | FC | FC | | GB | | HB | HB | | |
| 220,000 | 224 | M,Z | | | EC | FC | FC | | GB | | HB | HB | | |
| 270,000 | 274 | M,Z | | | | FC | FC | | GB | | HB | HB | | |
| 330,000 | 334 | M,Z | | | | | FD | | GB | | HB | HB | KB | KC |
| 390,000 | 394 | M,Z | | | | | FD | | GB | | HB | HD | KB | KC |
| 470,000 | 474 | M,Z | | | | | FD | | GB | | HB | | KB | KC |
| 560,000 | 564 | M,Z | | | | | FD | | GC | | HB | | KB | |
| 680,000 | 684 | M,Z | | | | | FD | | GC | | HB | | KB | |
| 820,000 | 824 | M,Z | | | | | | FF | GE | | HB | | KB | |
| 1,000,000 | 105 | M,Z | | | | | | FH | GE | | HB | | KB | |
| 1,200,000 | 125 | M,Z | | | | | | | | | HB | | KB | |
| 1,500,000 | 155 | M,Z | | | | | | | | | HB | | KB | |
| 1,800,000 | 185 | M,Z | | | | | | | | | HB | | KD | |
| 2,200,000 | 225 | M,Z | | | | | | | | | HB | | KD | |
| 2,700,000 | 275 | M,Z | | | | | | | | | HB | | KD | |

NOTE: For non-standard capacitance values or voltages, contact your local KEMET sales representative. 50 Volt Ceramic Chips can be used for 63 volt applications.

* EIA preferred chip sizes

See page 78 for Thickness Code Reference Chart.

FEATURES

KEMET's line of Tin/Lead termination commercial MLCC surface mount capacitors are designed to meet the needs of the commercial, high reliability, and military customer applications where Tin/Lead plating is required. KEMET's Tin/Lead electroplating process is designed to meet a 5% minimum lead content in the termination of the component. As the bulk of the electronics industry marches to RoHS compliance it is important that KEMET provide the Tin/Lead terminated products for our valued high reliability and military customers.

KEMET Tin/Lead MLCC surface mount capacitors are available in standard EIA case sizes from 0402 to 2225 and standard capacitance values in X7R and C0G dielectrics. Voltage ratings range from 6.3V to 200V. To order the Tin/Lead terminations indicate an "L" in the 14th digit of the part number. To request the L Series termination for other surface mount product lines (Open Mode, High Voltage, Arrays, etc.) or for additional dielectrics and higher voltage ratings, please contact the factory or local Sales representative.

CAPACITOR OUTLINE DRAWINGS

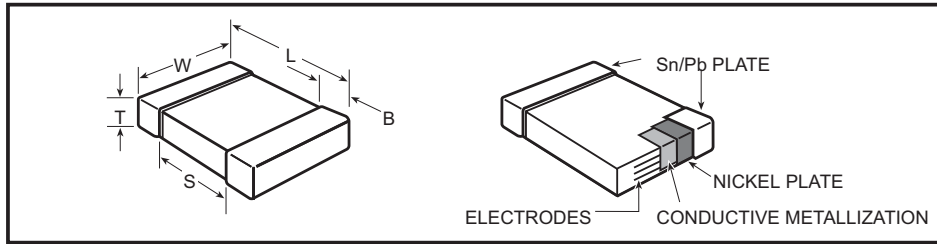

DIMENSIONS—MILLIMETERS AND (INCHES)

| EIA SIZE CODE | METRIC SIZE CODE (Ref only) | L # LENGTH | W # WIDTH | See page 78 for thickness dimensions. | B BANDWIDTH | | S MIN. SEPARATION | | MOUNTING TECHNIQUE |
|---------------|-----------------------------|--------------------------|--------------------------|---------------------------------------|---------------------------|------|-------------------|------|--------------------------------------|
| | | | | | MIN. | MAX. | MIN. | MAX. | |
| 0402* | 1005 | 1.0 (.04) ± .05 (.002) | 0.5 (.02) ± .05 (.002) | | 0.20 (0.008)-0.40 (0.016) | | 0.3 (.012) | | Solder Reflow |
| 0603* | 1608 | 1.6 (.063) ± 0.15 (.006) | 0.8 (.032) ± 0.15 (.006) | | 0.35 (.014) ± 0.15 (.006) | | 0.7 (.028) | | Solder Wave † or Solder Reflow |
| 0805* | 2012 | 2.0 (.079) ± 0.2 (.008) | 1.25 (.049) ± 0.2 (.008) | | 0.5 (.02) ± .25 (.010) | | 0.75 (.030) | | |
| 1206* | 3216 | 3.2 (.126) ± 0.2 (.008) | 1.6 (.063) ± 0.2 (.008) | | 0.5 (.02) ± .25 (.010) | | N/A | | |
| 1210* | 3225 | 3.2 (.126) ± 0.2 (.008) | 2.5 (.098) ± 0.2 (.008) | | 0.5 (.02) ± .25 (.010) | | N/A | | Solder Reflow |
| 1812 | 4532 | 4.5 (.177) ± 0.3 (.012) | 3.2 (.126) ± 0.3 (.012) | | 0.6 (.024) ± .35 (.014) | | N/A | | |
| 1825* | 4564 | 4.5 (.177) ± 0.3 (.012) | 6.4 (.252) ± 0.4 (.016) | | 0.6 (.024) ± .35 (.014) | | N/A | | |
| 2220 | 5650 | 5.6 (.220) ± 0.4 (.016) | 5.0 (.197) ± 0.4 (.016) | | 0.6 (.024) ± .35 (.014) | | N/A | | |
| 2225 | 5664 | 5.6 (.220) ± 0.4 (.016) | 6.3 (.248) ± 0.4 (.016) | 0.6 (.024) ± .35 (.014) | | N/A | | | |

* Note: Indicates EIA Preferred Case Sizes (Tightened tolerances apply for 0402, 0603, and 0805 packaged in bulk cassette, see page 96).
 † For extended value 1210 case size - solder reflow only.

CAPACITOR ORDERING INFORMATION (Standard Chips - For Military see page 87)

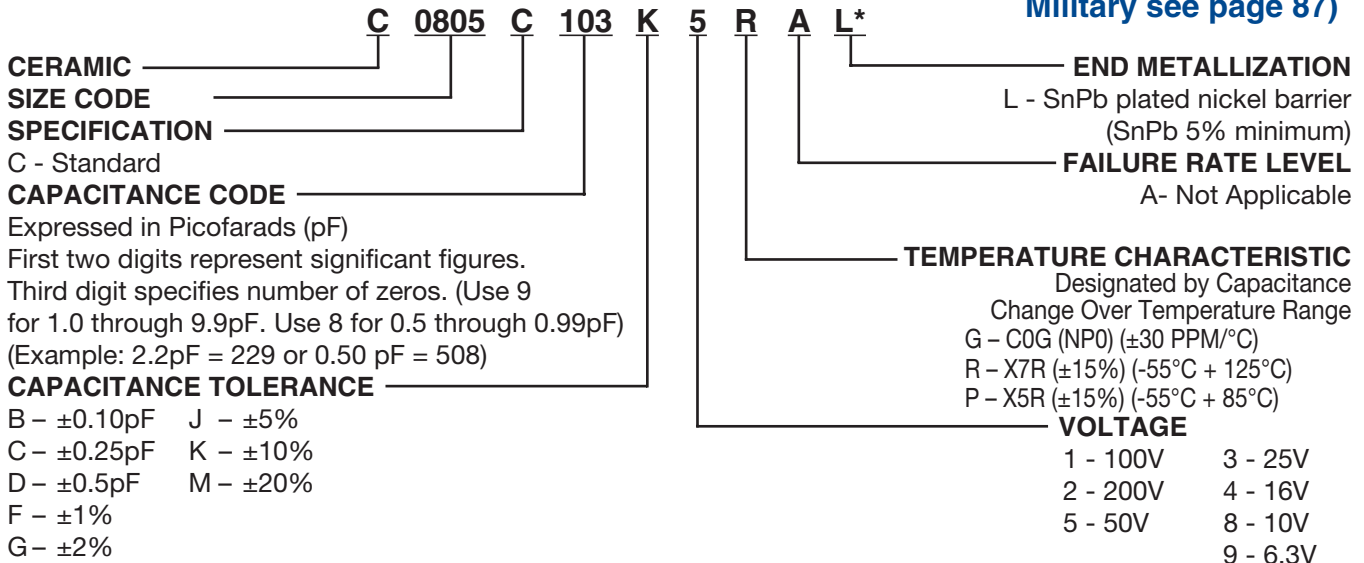

* Part Number Example: C0805C103K5RAL (14 digits - no spaces)

Refer to pages 73-76 for NP0/C0G, X7R and X5R dielectric capacitance ranges available.

©KEMET Electronics Corporation, P.O. Box 5928, Greenville, S.C. 29606, (864) 963-6300

Thickness Code Reference Chart Packaging Quantity Based on Finished Chip Thickness Specifications

| Thickness Code | Chip Size | Chip Thickness Range (mm) | Qty per Reel 7" Plastic | Qty per Reel 13" Plastic | Qty per Reel 7" Paper | Qty per Reel 13" Paper | Qty per Bulk Cassette |
|----------------|-----------|---------------------------|-------------------------|--------------------------|-----------------------|------------------------|-----------------------|
| AA | 0201 | .30 ± .03 | N/A | N/A | 15,000 | N/A | N/A |
| BB | 0402 | .50 ± .05 | N/A | N/A | 10,000 | 50,000 | 50,000 |
| CB | 0603 | .80 ± .07 | N/A | N/A | 4,000 | 10,000 | 15,000 |
| CC | 0603 | .80 ± .10 | N/A | N/A | 4,000 | 10,000 | N/A |
| CD | 0603 | .80 ± .15 | N/A | N/A | 4,000 | 10,000 | N/A |
| DB | 0805 | .60 ± .10 | N/A | N/A | N/A | N/A | 10,000 |
| DC | 0805 | .78 ± .10 | 4,000 | 10,000 | 4,000 | 10,000 | N/A |
| DD | 0805 | .90 ± .10 | 4,000 | 10,000 | N/A | N/A | N/A |
| DE | 0805 | 1.00 ± .10 | 2,500 | 10,000 | N/A | N/A | N/A |
| DF | 0805 | 1.10 ± .10 | 2,500 | 10,000 | N/A | N/A | N/A |
| DG | 0805 | 1.25 ± .15 | 2,500 | 10,000 | N/A | N/A | N/A |
| DH | 0805 | 1.25 ± .20 | 2,500 | 10,000 | N/A | N/A | N/A |
| DJ | 0805 | 1.25 ± .20 | 3,000 | 10,000 | N/A | N/A | N/A |
| DK | 0805 | 1.25 ± .15 | 3,000 | 10,000 | N/A | N/A | N/A |
| EB | 1206 | .78 ± .10 | 4,000 | 10,000 | 4,000 | 10,000 | N/A |
| EC | 1206 | .90 ± .10 | 4,000 | 10,000 | N/A | N/A | N/A |
| ED | 1206 | 1.00 ± .10 | 2,500 | 10,000 | N/A | N/A | N/A |
| EE | 1206 | 1.10 ± .10 | 2,500 | 10,000 | N/A | N/A | N/A |
| EF | 1206 | 1.20 ± .15 | 2,500 | 10,000 | N/A | N/A | N/A |
| EG | 1206 | 1.60 ± .15 | 2,000 | 8,000 | N/A | N/A | N/A |
| EH | 1206 | 1.60 ± .20 | 2,000 | 8,000 | N/A | N/A | N/A |
| EJ | 1206 | 1.70 ± .20 | 2,000 | 8,000 | N/A | N/A | N/A |
| EK | 1206 | .80 ± .10 | 2,000 | 8,000 | N/A | N/A | N/A |
| EL | 1206 | 1.15 ± .15 | 2,000 | 8,000 | N/A | N/A | N/A |
| EM | 1206 | 1.25 ± .15 | 2,500 | 10,000 | N/A | N/A | N/A |
| EN | 1206 | 0.95 ± .10 | 4,000 | 10,000 | N/A | N/A | N/A |
| FB | 1210 | .78 ± .10 | 4,000 | 10,000 | N/A | N/A | N/A |
| FC | 1210 | .90 ± .10 | 4,000 | 10,000 | N/A | N/A | N/A |
| FD | 1210 | .95 ± .10 | 4,000 | 10,000 | N/A | N/A | N/A |
| FE | 1210 | 1.00 ± .10 | 2,500 | 10,000 | N/A | N/A | N/A |
| FF | 1210 | 1.10 ± .10 | 2,500 | 10,000 | N/A | N/A | N/A |
| FG | 1210 | 1.25 ± .15 | 2,500 | 10,000 | N/A | N/A | N/A |
| FH | 1210 | 1.55 ± .15 | 2,000 | 8,000 | N/A | N/A | N/A |
| FJ | 1210 | 1.85 ± .20 | 2,000 | 8,000 | N/A | N/A | N/A |
| FK | 1210 | 2.10 ± .20 | 2,000 | 8,000 | N/A | N/A | N/A |
| FL | 1210 | 1.40 ± .15 | 2,000 | 8,000 | N/A | N/A | N/A |
| FM | 1210 | 1.70 ± .20 | 2,000 | 8,000 | N/A | N/A | N/A |
| FN | 1210 | 1.85 ± .20 | 2,000 | 8,000 | N/A | N/A | N/A |
| FO | 1210 | 1.50 ± .20 | 2,000 | 8,000 | N/A | N/A | N/A |
| FP | 1210 | 1.60 ± .20 | 2,000 | 8,000 | N/A | N/A | N/A |
| FQ | 1210 | 2.5 ± .20 | 1,500 | 8,000 | N/A | N/A | N/A |
| FR | 1210 | 2.25 ± .20 | 2,000 | 8,000 | N/A | N/A | N/A |
| FS | 1210 | 2.50 ± .20 | 1,000 | 4,000 | N/A | N/A | N/A |
| GB | 1812 | 1.00 ± .10 | 1,000 | 4,000 | N/A | N/A | N/A |
| GC | 1812 | 1.10 ± .10 | 1,000 | 4,000 | N/A | N/A | N/A |
| GD | 1812 | 1.25 ± .15 | 1,000 | 4,000 | N/A | N/A | N/A |
| GE | 1812 | 1.30 ± .10 | 1,000 | 4,000 | N/A | N/A | N/A |
| GF | 1812 | 1.50 ± .10 | 1,000 | 4,000 | N/A | N/A | N/A |
| GG | 1812 | 1.55 ± .10 | 1,000 | 4,000 | N/A | N/A | N/A |
| GH | 1812 | 1.40 ± .15 | 1,000 | 4,000 | N/A | N/A | N/A |
| GJ | 1812 | 1.70 ± .15 | 1,000 | 4,000 | N/A | N/A | N/A |
| GK | 1812 | 1.60 ± .20 | 1,000 | 4,000 | N/A | N/A | N/A |
| GL | 1812 | 1.90 ± .20 | 1,000 | 4,000 | N/A | N/A | N/A |
| GM | 1812 | 2.00 ± .20 | 1,000 | 4,000 | N/A | N/A | N/A |
| GN | 1812 | 1.70 ± .20 | 1,000 | 4,000 | N/A | N/A | N/A |
| HB | 1825 | 1.10 ± .15 | 1,000 | 4,000 | N/A | N/A | N/A |
| HC | 1825 | 1.15 ± .15 | 1,000 | 4,000 | N/A | N/A | N/A |
| HD | 1825 | 1.30 ± .15 | 1,000 | 4,000 | N/A | N/A | N/A |
| HE | 1825 | 1.40 ± .15 | 1,000 | 4,000 | N/A | N/A | N/A |
| HF | 1825 | 1.50 ± .15 | 1,000 | 4,000 | N/A | N/A | N/A |
| JB | 2220 | 1.00 ± .15 | 1,000 | 4,000 | N/A | N/A | N/A |
| JC | 2220 | 1.10 ± .15 | 1,000 | 4,000 | N/A | N/A | N/A |
| JD | 2220 | 1.30 ± .15 | 1,000 | 4,000 | N/A | N/A | N/A |
| JE | 2220 | 1.40 ± .15 | 1,000 | 4,000 | N/A | N/A | N/A |
| JF | 2220 | 1.50 ± .15 | 1,000 | 4,000 | N/A | N/A | N/A |
| KB | 2225 | 1.00 ± .15 | 1,000 | 4,000 | N/A | N/A | N/A |
| KC | 2225 | 1.10 ± .15 | 1,000 | 4,000 | N/A | N/A | N/A |
| KD | 2225 | 1.30 ± .15 | 1,000 | 4,000 | N/A | N/A | N/A |
| KE | 2225 | 1.40 ± .15 | 1,000 | 4,000 | N/A | N/A | N/A |

This chart refers to ceramic chip thickness codes on pages 73-76.

FEATURES

KEMET's Open Mode Ceramic Surface Mount Capacitor is designed to significantly minimize the probability of a low IR or Short Circuit Condition when forced to failure in a board flex situation. This reduces the potential for causing catastrophic failures. This product is RoHS Compliant.

Applications:

- Input side filtering (power plane/bus)
- High current applications (battery line)
- Circuits that cannot be fused to open when short circuits occur due to flex cracks

Markets:

- *Automotive*
 - All applications connected directly to the battery
 - Conversion to 42V power system
- *Power Conversion*
 - Raw power input side filtering

OUTLINE DRAWING

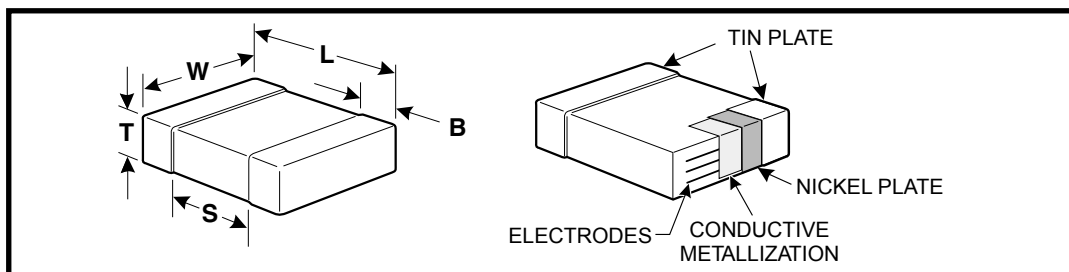
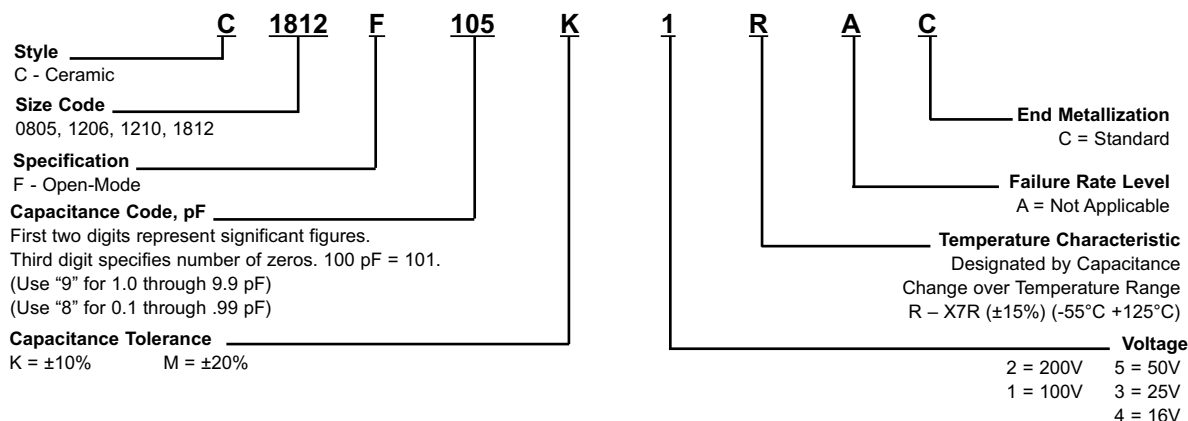

TABLE 1 - DIMENSIONS - MILLIMETERS (INCHES)

| Metric Size Code | EIA Size Code | L - Length | W - Width | B - Bandwidth | Separation |
|------------------|---------------|-------------------------|--------------------------|--------------------------|-------------|
| 2012 | 0805 | 2.0 (.079) ± .20 (.008) | 1.25 (.049) ± 0.2 (.008) | 0.50 (.02) ± .25 (.010) | 0.75 (.030) |
| 3216 | 1206 | 3.2 (.126) ± .20 (.008) | 1.6 (.063) ± 0.2 (.008) | 0.50 (.02) ± .25 (.010) | N/A |
| 3225 | 1210 | 3.2 (.126) ± .20 (.008) | 2.5 (.098) ± 0.2 (.008) | 0.50 (.02) ± .25 (.010) | N/A |
| 4532 | 1812 | 4.5 (.177) ± 0.3 (.012) | 3.2 (.126) ± 0.3 (.012) | 0.60 (.024) ± .35 (.014) | N/A |

Note: For thickness dimensions, see Table 2.

CAPACITOR ORDERING INFORMATION



OPEN-MODE INTERNAL DESIGN

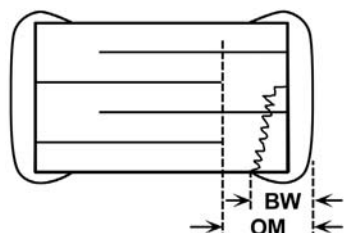

The open-mode dimension (OM) exceeds the termination bandwidth dimensions: OM > BW

Ceramic Surface Mount

TABLE 2

X7R DIELECTRIC CAPACITANCE RANGE AND THICKNESS TARGETS (mm)

| Cap Code | 0805 | | | | | 1206 | | | | | 1210 | | | | | 1812 | | | |
|----------|------|-----|-----|------|------|------|-----|-----|------|------|------|-----|-----|------|------|------|-----|------|------|
| | 16V | 25V | 50V | 100V | 200V | 16V | 25V | 50V | 100V | 200V | 16V | 25V | 50V | 100V | 200V | 25V | 50V | 100V | 200V |
| 102 | DD | DD | DD | DD | DD | | | | | | | | | | | | | | |
| 122 | DD | DD | DD | DD | DD | | | | | | | | | | | | | | |
| 152 | DD | DD | DD | DD | DD | | | | | | | | | | | | | | |
| 182 | DD | DD | DD | DD | DD | | | | | | | | | | | | | | |
| 222 | DD | DD | DD | DD | DD | | | | | | | | | | | | | | |
| 272 | DD | DD | DD | DD | DD | | | | | | | | | | | | | | |
| 332 | DD | DD | DD | DD | DD | | | | | | | | | | | | | | |
| 392 | DD | DD | DD | DD | DD | | | | | | | | | | | | | | |
| 472 | DD | DD | DD | DD | DD | | | | | | | | | | | | | | |
| 562 | DD | DD | DD | DD | DD | | | | | | | | | | | | | | |
| 682 | DD | DD | DD | DD | DD | | | | | | | | | | | | | | |
| 822 | DD | DD | DD | DD | DD | | | | | | | | | | | | | | |
| 103 | DD | DD | DD | DD | DD | | | | | | | | | | | | | | |
| 123 | DD | DD | DD | DD | DG | | | | | | | | | | | | | | |
| 153 | DD | DD | DD | DD | DG | | | | | | | | | | | | | | |
| 183 | DD | DD | DD | DD | | | | | | EC | | | | | | | | | |
| 223 | DD | DD | DD | DG | | | | | | EC | | | | | | | | | |
| 273 | DD | DD | DD | DG | | | | | | EC | | | | | | | | | |
| 333 | DD | DD | DD | DG | | | | | | EC | | | | | | | | | |
| 393 | DD | DD | DD | DG | | | | | | EC | | | | | | | | | |
| 473 | DD | DD | DD | DE | | EC | EC | EC | EC | EG | | | | | | | | | GB |
| 563 | DD | DD | DD | | | EC | EC | EC | EC | EG | | | | | | | | | GB |
| 683 | DD | DD | DG | DG | | EC | EC | EC | EC | EG | | | | FD | | | | | GB |
| 823 | DD | DD | DG | | | EC | EC | EC | EC | EG | | | | FD | | | | | GB |
| 104 | DG | DG | DG | | | EC | EC | EC | EC | EG | FD | FD | FD | FD | FG | GB | GB | GB | GB |
| 124 | DG | DG | | | | EC | EC | EC | EC | | FD | FD | FD | FD | FG | GB | GB | GB | GB |
| 154 | DG | DG | | | | EC | EC | EC | EG | | FD | FD | FD | FD | FH | GB | GB | GB | GB |
| 184 | DG | DG | | | | EC | EC | EC | EG | | FD | FD | FD | FD | FH | GB | GB | GB | GB |
| 224 | DG | DD | DG | | | EC | EC | EC | ED | | FD | FD | FD | FG | FJ | GB | GB | GB | GC |
| 274 | | | | | | EC | EC | EC | | | FD | FD | FD | FG | | GB | GB | GB | GF |
| 334 | | | | | | EG | EG | EG | EG | | FD | FD | FD | FH | | GB | GB | GB | GK |
| 394 | | | | | | EG | EG | | | | FD | FD | FG | FH | | GB | GB | GB | GL |
| 474 | DE | DG | | | | EG | EG | EC | | | FD | FD | FG | FJ | | GB | GB | GC | |
| 564 | | | | | | EG | | | | | FD | FD | FG | FR | | GB | GB | GD | |
| 684 | DG | | | | | EG | | | | | FD | FG | FH | FR | | GD | GD | GF | |
| 824 | | | | | | EG | | | | | FD | FG | FJ | | | GD | GD | GK | |
| 105 | | | | | | EG | EC | EH | | | FD | FH | FJ | FQ | | GN | GN | GM | |
| 125 | | | | | | | | | | | FG | | | | | | | | |
| 155 | | | | | | | | | | | FH | | | | | | | | |
| 185 | | | | | | | | | | | FH | | | | | | | | |
| 225 | | | | | | EC | EH | | | | FJ | | FM | | | | | | |
| 475 | | | | | | EH | | | | | FG | FM | | | | | | | |
| 685 | | | | | | | | | | | FQ | | | | | | | | |

THICKNESS AND PACKAGING INFORMATION

| Thickness Code | Series | Dimension | 7" Reel Qty. | 13" Reel Qty. |
|----------------|--------|------------|--------------|---------------|
| DD | 0805 | .90 ± .10 | 4000 | 10000 |
| DE | 0805 | 1.00 ± .10 | 2500 | 10000 |
| DG | 0805 | 1.25 ± .15 | 2500 | 10000 |
| EC | 1206 | .90 ± .10 | 4000 | 10000 |
| EG | 1206 | 1.60 ± .15 | 2000 | 8000 |
| EH | 1206 | 1.60 ± .20 | 2000 | 8000 |
| FD | 1210 | .95 ± .10 | 4000 | 10000 |
| FG | 1210 | 1.25 ± .15 | 2500 | 10000 |
| FH | 1210 | 1.55 ± .15 | 2000 | 8000 |
| FJ | 1210 | 1.85 ± .20 | 2000 | 8000 |
| FM | 1210 | 1.70 ± .20 | 2000 | 8000 |
| FR | 1210 | 2.25 ± .20 | 2000 | 8000 |
| FQ | 1210 | 2.5 ± .20 | 1500 | 8000 |
| GB | 1812 | 1.0 ± .10 | 1000 | 4000 |
| GC | 1812 | 1.1 ± .10 | 1000 | 4000 |
| GD | 1812 | 1.25 ± .15 | 1000 | 4000 |
| GF | 1812 | 1.50 ± .15 | 1000 | 4000 |
| GK | 1812 | 1.60 ± .20 | 1000 | 4000 |
| GL | 1812 | 1.90 ± .20 | 1000 | 4000 |
| GM | 1812 | 2.00 ± .20 | 1000 | 4000 |
| GN | 1812 | 1.70 ± .20 | 1000 | 4000 |

KEMET's High Voltage Surface Mount Capacitors are designed to withstand high voltage applications. They offer high capacitance with low leakage current and low ESR at high frequency. The capacitors have pure tin (Sn) plated external electrodes for good solderability. X7R dielectrics are not designed for AC line filtering applications. An insulating coating may be required to prevent surface arcing. These components are RoHS compliant.

APPLICATIONS

- Switch Mode Power Supply
 - Input Filter
 - Resonators
 - Tank Circuit
 - Snubber Circuit
 - Output Filter
- High Voltage Coupling
- High Voltage DC Blocking
- Lighting Ballast
- Voltage Multiplier Circuits
- Coupling Capacitor/CLK

MARKETS

- Power Supply
- High Voltage Power Supply
- DC-DC Converter
- LCD Fluorescent Backlight Ballast
- HID Lighting
- Telecommunications Equipment
- Industrial Equipment/Control
- Medical Equipment/Control
- Computer (LAN/WAN Interface)
- Analog and Digital Modems
- Automotive

OUTLINE DRAWING

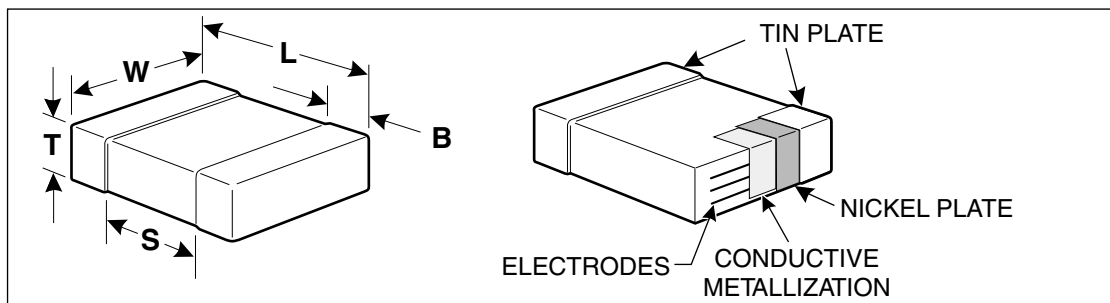

TABLE 1 - DIMENSIONS - MILLIMETERS (in.)

| Metric Code | EIA Size Code | L - Length | W - Width | B - Bandwidth | Band Separation |
|-------------|---------------|------------------------------|------------------------------|-------------------------------|-----------------|
| 2012 | 0805 | 2.0 (0.079) ± 0.2 (0.008) | 1.2 (0.049) ± 0.2 (0.008) | 0.5 (0.02) ±0.25 (0.010) | 0.75 (0.030) |
| 3216 | 1206 | 3.2 (0.126) ± 0.2 (0.008) | 1.6 (0.063) ± 0.2 (0.008) | 0.5 (0.02) ± 0.25 (0.010) | N/A |
| 3225 | 1210 | 3.2 (0.126) ± 0.2 (0.008) | 2.5 (0.098) ± 0.2 (0.008) | 0.5 (0.02) ± 0.25 (0.010) | N/A |
| 4520 | 1808 | 4.5 (0.177) ± 0.3 (0.012) | 2.0 (0.079) ± 0.2 (0.008) | 0.6 (0.024) ± 0.35 (0.014) | N/A |
| 4532 | 1812 | 4.5 (0.177) ± 0.3 (0.012) | 3.2 (0.126) ± 0.3 (0.012) | 0.6 (0.024) ± 0.35 (0.014) | N/A |
| 4564 | 1825 | 4.5 (0.177) ± 0.3 (0.012) | 6.4 (0.250) ± 0.4 (0.016) | 0.6 (0.024) ± 0.35 (0.014) | N/A |
| 5650 | 2220 | 5.6 (0.224) ± 0.4 (0.016) | 5.0 (0.197) ± 0.4 (0.016) | 0.6 (0.024) ± 0.35 (0.014) | N/A |
| 5664 | 2225 | 5.6 (0.224) ± 0.4 (0.016) | 6.4 (0.250) ± 0.4 (0.016) | 0.6 (0.024) ± 0.35 (0.014) | N/A |

Ceramic Surface Mount

C0G DIELECTRIC CAPACITANCE VALUES AND THICKNESS TARGETS (in.)

| Cap pF | Capacitance Tolerance * | Series | 0805 | | 1206 | | | 1210 | | | 1808 | | | 1812 | | | 1825 | | | 2220 | | | 2225 | | |
|-----------|-------------------------------|--------------------------|---------|-------|-------|-------|-------|-------|-------|-------|-------|-------|-------|-------|-------|-------|-------|-------|-------|-------|-------|-------|-------|------|--|
| | | Max Thickness (in) | 0.050 | 0.050 | 0.065 | 0.065 | 0.065 | 0.065 | 0.065 | 0.065 | 0.065 | 0.065 | 0.067 | 0.067 | 0.067 | 0.067 | 0.067 | 0.067 | 0.067 | 0.067 | 0.067 | 0.067 | 0.067 | | |
| | | Cap Code/ Voltage | 500 | 1000 | 500 | 1000 | 1500 | 2000 | 500 | 1000 | 1500 | 2000 | 500 | 1000 | 1500 | 2000 | 2500 | 3000 | 500 | 1000 | 1500 | 2000 | 2500 | 3000 | |
| 10-24 | C,D | | | | | | | | | | | | | | | | | | | | | | | | |
| 2.7-5.1 | C,D | K,M | 279-519 | | | | | | | | | | | | | | | | | | | | | | |
| 5.6-9.1 | C,D | J,K,M | 569-919 | | | | | | | | | | | | | | | | | | | | | | |
| 10 | C,D | J,K,M | 100 | | | | | | | | | | | | | | | | | | | | | | |
| 11 | C,D | J,K,M | 110 | | | | | | | | | | | | | | | | | | | | | | |
| 12 | C,D | J,K,M | 120 | | | | | | | | | | | | | | | | | | | | | | |
| 13 | C,D | J,K,M | 130 | | | | | | | | | | | | | | | | | | | | | | |
| 15 | C,D | G,J,K,M | 150 | | | | | | | | | | | | | | | | | | | | | | |
| 16 | C,D | G,J,K,M | 160 | | | | | | | | | | | | | | | | | | | | | | |
| 18 | C,D | G,J,K,M | 180 | | | | | | | | | | | | | | | | | | | | | | |
| 20 | C,D | G,J,K,M | 200 | | | | | | | | | | | | | | | | | | | | | | |
| 22 | C,D | G,J,K,M | 220 | | | | | | | | | | | | | | | | | | | | | | |
| 24 | C,D | G,J,K,M | 240 | | | | | | | | | | | | | | | | | | | | | | |
| 27 | D,F,G,J,K,M | | 270 | | | | | | | | | | | | | | | | | | | | | | |
| 30 | D,F,G,J,K,M | | 300 | | | | | | | | | | | | | | | | | | | | | | |
| 33 | D,F,G,J,K,M | | 330 | | | | | | | | | | | | | | | | | | | | | | |
| 36 | D,F,G,J,K,M | | 360 | | | | | | | | | | | | | | | | | | | | | | |
| 39 | D,F,G,J,K,M | | 390 | | | | | | | | | | | | | | | | | | | | | | |
| 43 | D,F,G,J,K,M | | 430 | | | | | | | | | | | | | | | | | | | | | | |
| 47 | D,F,G,J,K,M | | 470 | | | | | | | | | | | | | | | | | | | | | | |
| 51 | D,F,G,J,K,M | | 510 | | | | | | | | | | | | | | | | | | | | | | |
| 56 | F,G,J,K,M | | 560 | | | | | | | | | | | | | | | | | | | | | | |
| 62 | F,G,J,K,M | | 620 | | | | | | | | | | | | | | | | | | | | | | |
| 68 | F,G,J,K,M | | 680 | | | | | | | | | | | | | | | | | | | | | | |
| 75 | F,G,J,K,M | | 750 | | | | | | | | | | | | | | | | | | | | | | |
| 82 | F,G,J,K,M | | 820 | | | | | | | | | | | | | | | | | | | | | | |
| 91 | F,G,J,K,M | | 910 | | | | | | | | | | | | | | | | | | | | | | |
| 100 | F,G,J,K,M | | 101 | | | | | | | | | | | | | | | | | | | | | | |
| 110 | F,G,J,K,M | | 111 | | | | | | | | | | | | | | | | | | | | | | |
| 120 | F,G,J,K,M | | 121 | | | | | | | | | | | | | | | | | | | | | | |
| 130 | F,G,J,K,M | | 131 | | | | | | | | | | | | | | | | | | | | | | |
| 150 | F,G,J,K,M | | 151 | | | | | | | | | | | | | | | | | | | | | | |
| 160 | F,G,J,K,M | | 161 | | | | | | | | | | | | | | | | | | | | | | |
| 180 | F,G,J,K,M | | 181 | | | | | | | | | | | | | | | | | | | | | | |
| 200 | F,G,J,K,M | | 201 | | | | | | | | | | | | | | | | | | | | | | |
| 220 | F,G,J,K,M | | 221 | | | | | | | | | | | | | | | | | | | | | | |
| 240 | F,G,J,K,M | | 241 | | | | | | | | | | | | | | | | | | | | | | |
| 270 | F,G,J,K,M | | 271 | | | | | | | | | | | | | | | | | | | | | | |
| 300 | F,G,J,K,M | | 301 | | | | | | | | | | | | | | | | | | | | | | |
| 330 | F,G,J,K,M | | 331 | | | | | | | | | | | | | | | | | | | | | | |
| 360 | F,G,J,K,M | | 361 | | | | | | | | | | | | | | | | | | | | | | |
| 390 | F,G,J,K,M | | 391 | | | | | | | | | | | | | | | | | | | | | | |
| 430 | F,G,J,K,M | | 431 | | | | | | | | | | | | | | | | | | | | | | |
| 470 | F,G,J,K,M | | 471 | | | | | | | | | | | | | | | | | | | | | | |
| 510 | F,G,J,K,M | | 511 | | | | | | | | | | | | | | | | | | | | | | |
| 560 | F,G,J,K,M | | 561 | | | | | | | | | | | | | | | | | | | | | | |
| 620 | F,G,J,K,M | | 621 | | | | | | | | | | | | | | | | | | | | | | |
| 680 | F,G,J,K,M | | 681 | | | | | | | | | | | | | | | | | | | | | | |
| 750 | F,G,J,K,M | | 751 | | | | | | | | | | | | | | | | | | | | | | |
| 820 | F,G,J,K,M | | 821 | | | | | | | | | | | | | | | | | | | | | | |
| 910 | F,G,J,K,M | | 911 | | | | | | | | | | | | | | | | | | | | | | |
| 1000 | F,G,J,K,M | | 102 | | | | | | | | | | | | | | | | | | | | | | |
| 1100 | F,G,J,K,M | | 112 | | | | | | | | | | | | | | | | | | | | | | |
| 1200 | F,G,J,K,M | | 122 | | | | | | | | | | | | | | | | | | | | | | |
| 1300 | F,G,J,K,M | | 132 | | | | | | | | | | | | | | | | | | | | | | |
| 1500 | F,G,J,K,M | | 152 | | | | | | | | | | | | | | | | | | | | | | |
| 1600 | F,G,J,K,M | | 162 | | | | | | | | | | | | | | | | | | | | | | |
| 1800 | F,G,J,K,M | | 182 | | | | | | | | | | | | | | | | | | | | | | |
| 2000 | F,G,J,K,M | | 202 | | | | | | | | | | | | | | | | | | | | | | |
| 2200 | F,G,J,K,M | | 222 | | | | | | | | | | | | | | | | | | | | | | |
| 2400 | F,G,J,K,M | | 242 | | | | | | | | | | | | | | | | | | | | | | |
| 2700 | F,G,J,K,M | | 272 | | | | | | | | | | | | | | | | | | | | | | |
| 3000 | F,G,J,K,M | | 302 | | | | | | | | | | | | | | | | | | | | | | |
| 3300 | F,G,J,K,M | | 332 | | | | | | | | | | | | | | | | | | | | | | |
| 3600 | F,G,J,K,M | | 362 | | | | | | | | | | | | | | | | | | | | | | |
| 3900 | F,G,J,K,M | | 392 | | | | | | | | | | | | | | | | | | | | | | |
| 4300 | F,G,J,K,M | | 432 | | | | | | | | | | | | | | | | | | | | | | |
| 4700 | F,G,J,K,M | | 472 | | | | | | | | | | | | | | | | | | | | | | |
| 5100 | F,G,J,K,M | | 512 | | | | | | | | | | | | | | | | | | | | | | |
| 5600 | F,G,J,K,M | | 562 | | | | | | | | | | | | | | | | | | | | | | |
| 6200 | F,G,J,K,M | | 622 | | | | | | | | | | | | | | | | | | | | | | |
| 6800 | F,G,J,K,M | | 682 | | | | | | | | | | | | | | | | | | | | | | |
| 7500 | F,G,J,K,M | | 752 | | | | | | | | | | | | | | | | | | | | | | |
| 8200 | F,G,J,K,M | | 822 | | | | | | | | | | | | | | | | | | | | | | |
| 9100 | F,G,J,K,M | | 912 | | | | | | | | | | | | | | | | | | | | | | |
| 10,000 | F,G,J,K,M | | 103 | | | | | | | | | | | | | | | | | | | | | | |

* Contact KEMET Sales Representative for C, D, F & G Capacitance Tolerance availability.

Note: Actual thickness dimensions may be less than stated maximum. Check the KEMET website, www.kemet.com, for additional values and chip sizes available.

X7R DIELECTRIC CAPACITANCE VALUES AND THICKNESS TARGETS (in.)

| Cap pF | Capacitance Tolerance | Series | 0805 | | 1206 | | 1210 | | 1808 | | 1812 | | 1825 | | 2220 | | 2225 | | |
|---------|-----------------------|--------------------|-------|-------|-------|-------|-------|-------|-------|-------|-------|-------|-------|-------|-------|-------|-------|-------|-------|
| | | Max Thickness (in) | 0.050 | 0.050 | 0.065 | 0.065 | 0.080 | 0.080 | 0.080 | 0.080 | 0.080 | 0.087 | 0.087 | 0.087 | 0.087 | 0.087 | 0.087 | 0.087 | 0.087 |
| | | Cap Code/ Voltage | 500 | 1000 | 500 | 1000 | 1500 | 2000 | 500 | 1000 | 1500 | 2000 | 2500 | 3000 | 500 | 1000 | 1500 | 2000 | 2500 |
| 10 | J,K,M | 100 | | | | | | | | | | | | | | | | | |
| 11 | J,K,M | 110 | | | | | | | | | | | | | | | | | |
| 12 | J,K,M | 120 | | | | | | | | | | | | | | | | | |
| 13 | J,K,M | 130 | | | | | | | | | | | | | | | | | |
| 15 | J,K,M | 150 | | | | | | | | | | | | | | | | | |
| 16 | J,K,M | 160 | | | | | | | | | | | | | | | | | |
| 18 | J,K,M | 180 | | | | | | | | | | | | | | | | | |
| 20 | J,K,M | 200 | | | | | | | | | | | | | | | | | |
| 22 | J,K,M | 220 | | | | | | | | | | | | | | | | | |
| 24 | J,K,M | 240 | | | | | | | | | | | | | | | | | |
| 27 | J,K,M | 270 | | | | | | | | | | | | | | | | | |
| 30 | J,K,M | 300 | | | | | | | | | | | | | | | | | |
| 33 | J,K,M | 330 | | | | | | | | | | | | | | | | | |
| 36 | J,K,M | 360 | | | | | | | | | | | | | | | | | |
| 39 | J,K,M | 390 | | | | | | | | | | | | | | | | | |
| 43 | J,K,M | 430 | | | | | | | | | | | | | | | | | |
| 47 | J,K,M | 470 | | | | | | | | | | | | | | | | | |
| 51 | J,K,M | 510 | | | | | | | | | | | | | | | | | |
| 56 | J,K,M | 560 | | | | | | | | | | | | | | | | | |
| 62 | J,K,M | 620 | | | | | | | | | | | | | | | | | |
| 68 | J,K,M | 680 | | | | | | | | | | | | | | | | | |
| 75 | J,K,M | 750 | | | | | | | | | | | | | | | | | |
| 82 | J,K,M | 820 | | | | | | | | | | | | | | | | | |
| 91 | J,K,M | 910 | | | | | | | | | | | | | | | | | |
| 100 | J,K,M | 101 | | | | | | | | | | | | | | | | | |
| 110 | J,K,M | 111 | | | | | | | | | | | | | | | | | |
| 120 | J,K,M | 121 | | | | | | | | | | | | | | | | | |
| 130 | J,K,M | 131 | | | | | | | | | | | | | | | | | |
| 150 | J,K,M | 151 | | | | | | | | | | | | | | | | | |
| 180 | J,K,M | 181 | | | | | | | | | | | | | | | | | |
| 220 | J,K,M | 221 | | | | | | | | | | | | | | | | | |
| 270 | J,K,M | 271 | | | | | | | | | | | | | | | | | |
| 330 | J,K,M | 331 | | | | | | | | | | | | | | | | | |
| 390 | J,K,M | 391 | | | | | | | | | | | | | | | | | |
| 470 | J,K,M | 471 | | | | | | | | | | | | | | | | | |
| 560 | J,K,M | 561 | | | | | | | | | | | | | | | | | |
| 680 | J,K,M | 681 | | | | | | | | | | | | | | | | | |
| 820 | J,K,M | 821 | | | | | | | | | | | | | | | | | |
| 1000 | J,K,M | 102 | | | | | | | | | | | | | | | | | |
| 1200 | J,K,M | 122 | | | | | | | | | | | | | | | | | |
| 1500 | J,K,M | 152 | | | | | | | | | | | | | | | | | |
| 1800 | J,K,M | 182 | | | | | | | | | | | | | | | | | |
| 2000 | J,K,M | 202 | | | | | | | | | | | | | | | | | |
| 2200 | J,K,M | 222 | | | | | | | | | | | | | | | | | |
| 2700 | J,K,M | 272 | | | | | | | | | | | | | | | | | |
| 3300 | J,K,M | 332 | | | | | | | | | | | | | | | | | |
| 3900 | J,K,M | 392 | | | | | | | | | | | | | | | | | |
| 4700 | J,K,M | 472 | | | | | | | | | | | | | | | | | |
| 5600 | J,K,M | 562 | | | | | | | | | | | | | | | | | |
| 6800 | J,K,M | 682 | | | | | | | | | | | | | | | | | |
| 8200 | J,K,M | 822 | | | | | | | | | | | | | | | | | |
| 10,000 | J,K,M | 103 | | | | | | | | | | | | | | | | | |
| 12,000 | J,K,M | 123 | | | | | | | | | | | | | | | | | |
| 15,000 | J,K,M | 153 | | | | | | | | | | | | | | | | | |
| 18,000 | J,K,M | 183 | | | | | | | | | | | | | | | | | |
| 22,000 | J,K,M | 223 | | | | | | | | | | | | | | | | | |
| 27,000 | J,K,M | 273 | | | | | | | | | | | | | | | | | |
| 33,000 | J,K,M | 333 | | | | | | | | | | | | | | | | | |
| 39,000 | J,K,M | 393 | | | | | | | | | | | | | | | | | |
| 47,000 | J,K,M | 473 | | | | | | | | | | | | | | | | | |
| 56,000 | J,K,M | 563 | | | | | | | | | | | | | | | | | |
| 62,000 | J,K,M | 623 | | | | | | | | | | | | | | | | | |
| 68,000 | J,K,M | 683 | | | | | | | | | | | | | | | | | |
| 82,000 | J,K,M | 823 | | | | | | | | | | | | | | | | | |
| 100,000 | J,K,M | 104 | | | | | | | | | | | | | | | | | |
| 120,000 | J,K,M | 124 | | | | | | | | | | | | | | | | | |
| 150,000 | J,K,M | 154 | | | | | | | | | | | | | | | | | |
| 180,000 | J,K,M | 184 | | | | | | | | | | | | | | | | | |
| 220,000 | J,K,M | 224 | | | | | | | | | | | | | | | | | |

Note: Actual thickness dimensions may be less than stated maximum.
Check the KEMET website, www.kemet.com, for additional values and chip sizes available.

KEMET HIGH VOLTAGE SURFACE MOUNT CHIP (VOLTAGE CODES C,D,F,G,H, and Z) THICKNESS AND REELING QUANTITIES

| Chip size | | Max. Thickness (in) | Max. Thickness (mm) | Tape Width (mm) | Qty per Reel 7" Plastic | Qty per Reel 13" Plastic |
|-----------|--------|---------------------|---------------------|-----------------|-------------------------|--------------------------|
| EIA | Metric | | | | | |
| 0805 | 2012 | 0.055 | 1.27 | 8 | 2,500 | 10,000 |
| 1206 | 3216 | 0.065 | 1.65 | 8 | 2,000 | 8,000 |
| 1210 | 3225 | 0.101 | 2.57 | 8 | 2,000 | 8,000 |
| 1808 | 4520 | 0.080 | 2.03 | 12 | 1,000 | 4,000 |
| 1812/1813 | 4532 | 0.067 | 1.70 | 12 | 1,000 | 4,000 |
| 1825 | 4564 | 0.067 | 1.70 | 12 | 1,000 | 4,000 |
| 2220 | 5650 | 0.067 | 1.70 | 12 | 1,000 | 4,000 |
| 2225 | 5664 | 0.067 | 1.70 | 12 | 1,000 | 4,000 |

Ceramic Surface Mount

CAPACITOR ORDERING INFORMATION

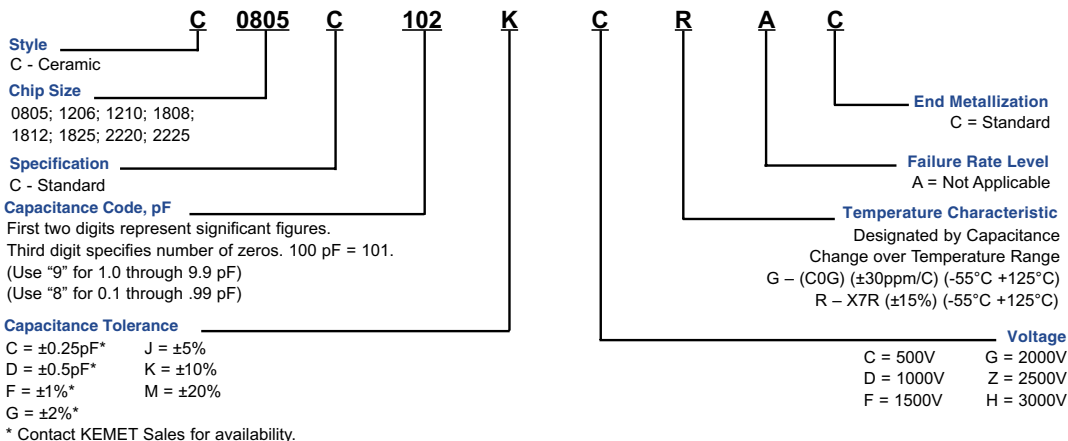

ELECTRICAL PARAMETERS

| Property | Specification |
|-----------------------------|--|
| Capacitance | C0G: 1 pF to 0.010 µF X7R: 10 pF to 0.22 µF 25°C, 1.0 ± 0.2 Vrms, 1 kHz (1 MHz for ≤ 1000 pF (C0G only)) |
| Cap Tolerance | C0G: C*, D*, F*, G*, J, K, M * Contact KEMET Sales for availability. X7R: J, K, M |
| DF | C0G: 0.1% Max X7R: 2.5% Max |
| Voltage Ratings | 500 V, 1000 V, 1500 V, 2000 V, 2500 V, 3000 V |
| Operating Temperature Range | From -55°C to +125°C |
| 25°C IR @ 500V | 100 GΩ or 1000 MΩ-µF, whichever is less |
| 125°C IR @ 500V | 10 GΩ or 100 MΩ-µF, whichever is less |
| -55°C TCC +125°C TCC | X7R: ± 15% C0G: ± 30 ppm / °C |
| Dielectric Strength | 150% of Rated Voltage for Rated Voltage <1000 V 120% of Rated Voltage for Rated Voltage ≥1000V |
| Ripple Current | Consult KEMET Sales Representative |

MARKING

These chips are supplied unmarked. If required, they can be supplied LASER-marked at an extra cost. Details on the marking format is located on page 97.

PACKAGING

KEMET High Voltage Surface Mount MLCC are available packaged in tape and reel configuration, or bulk bag as outlined on page 83. Please consult factory for waffle packaging options.

SOLDERING PROCESS

The 0805 and 1206 case sizes are suitable for either reflow or wave soldering processes. Sizes 1210 and larger should be limited to reflow soldering only. All sizes incorporate the standard KEMET barrier layer of pure nickel with an overplating of pure tin (Sn) for excellent solderability and resistance to solder leaching of the termination.

RECOMMENDED SOLDER PAD DIMENSIONS

| Chip Size | T (Total Length) | | S (Separation) | | W (Pad Width) | | L (Pad Length) | |
|-----------|------------------|-------|----------------|-------|---------------|-------|----------------|-------|
| | mm | in. | mm | in. | mm | in. | mm | in. |
| 0805 | 3.30 | 0.130 | 0.70 | 0.028 | 1.60 | 0.063 | 1.30 | 0.051 |
| 1206 | 4.50 | 0.177 | 1.50 | 0.059 | 2.00 | 0.079 | 1.50 | 0.059 |
| 1210 | 4.50 | 0.177 | 1.50 | 0.059 | 2.90 | 0.114 | 1.50 | 0.059 |
| 1808 | 5.90 | 0.232 | 2.30 | 0.091 | 2.40 | 0.094 | 1.80 | 0.071 |
| 1812 | 5.90 | 0.232 | 2.30 | 0.091 | 3.70 | 0.146 | 1.80 | 0.071 |
| 1825 | 5.90 | 0.232 | 2.30 | 0.091 | 6.90 | 0.272 | 1.80 | 0.071 |
| 2220 | 7.00 | 0.276 | 3.30 | 0.130 | 5.50 | 0.217 | 1.85 | 0.073 |
| 2225 | 7.00 | 0.276 | 3.30 | 0.130 | 6.80 | 0.268 | 1.85 | 0.073 |

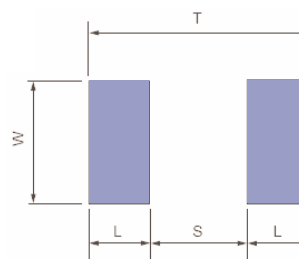

FEATURES

- Four individual capacitors inside one 1206 monolithic structure
- Saves board and inventory space
- One placement instead of four - less costly
- Easier to handle and solder than 4 smaller chips
- Tape and reel per EIA 481-1
- RoHS Compliant

CAPACITOR OUTLINE DRAWING

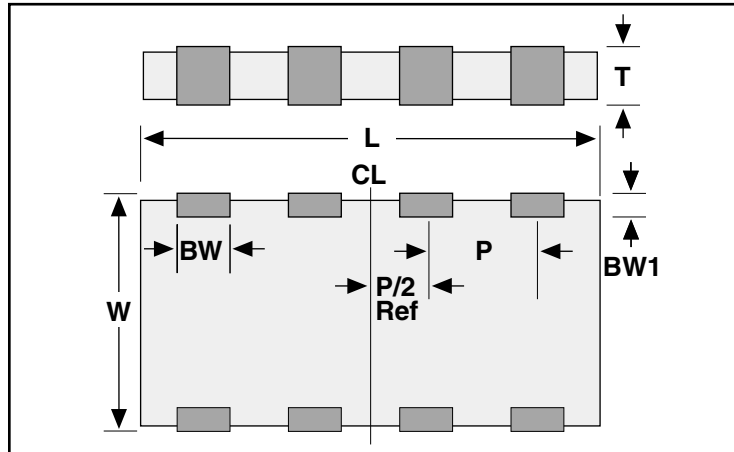

TABLE 1
EIA DIMENSIONS – MILLIMETERS (INCHES)

| Size Code | Length L | Width W | Thickness T (max.) | Bandwidth BW | Bandwidth BW1 | Pitch P |
|-----------|------------------------------|----------------------------|-------------------------------|-------------------------------|------------------------------|------------------------------|
| 1632 | 3.2 (0.126) ± 0.2 (0.008) | 1.6 (.063) ± 0.2 (.008) | 0.7 - 1.35 (0.027 - 0.053) | 0.40 (0.016) ± 0.2 (0.008) | 0.1 - 0.5 (0.004 - 0.020) | 0.8 (0.031) ± 0.1 (0.004) |

Notes:

1. Metric is controlling - English for reference only.
2. Pitch (P) tolerances are non-cumulative along the package.
3. Thickness (T) depends on capacitance.

CERAMIC ARRAY ORDERING INFORMATION

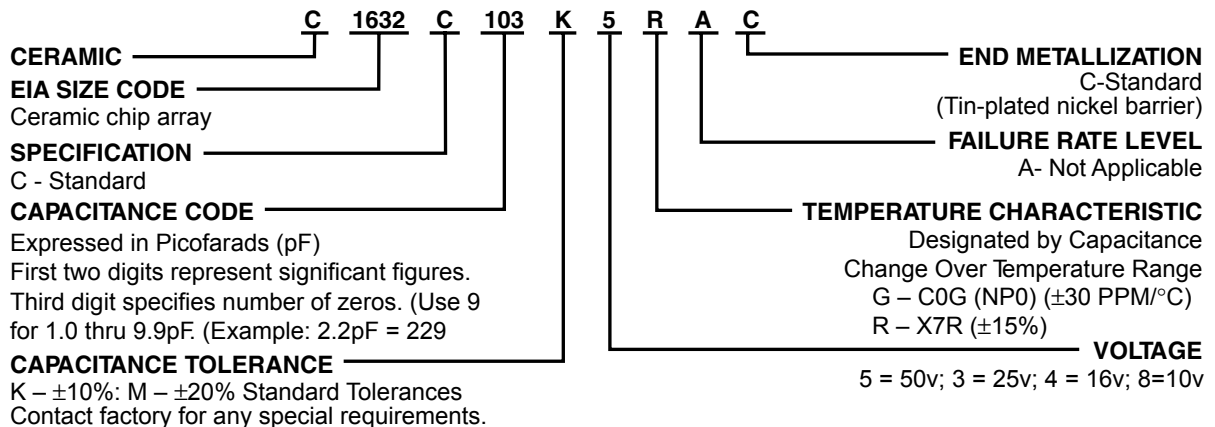

Ceramic Surface Mount

**TABLE 2A
COG DIELECTRIC – CAPACITANCE RANGE**

| Capacitance Values (pF) | KEMET Part Number | Capacitance Tolerance | 10V 16V | 25V | 50V | 100V | 200V |
|-------------------------|--------------------|-----------------------|---------|-----|-----|------|------|
| 10 | C1632C100(1)(2)GAC | K,M | 100 | 100 | 100 | 100 | 100 |
| 12 | C1632C120(1)(2)GAC | K,M | 120 | 120 | 120 | 120 | 120 |
| 15 | C1632C150(1)(2)GAC | K,M | 150 | 150 | 150 | 150 | 150 |
| 18 | C1632C180(1)(2)GAC | K,M | 180 | 180 | 180 | 180 | 180 |
| 22 | C1632C220(1)(2)GAC | K,M | 220 | 220 | 220 | 220 | 220 |
| 27 | C1632C270(1)(2)GAC | K,M | 270 | 270 | 270 | 270 | 270 |
| 33 | C1632C330(1)(2)GAC | K,M | 330 | 330 | 330 | 330 | 330 |
| 39 | C1632C390(1)(2)GAC | K,M | 390 | 390 | 390 | 390 | 390 |
| 47 | C1632C470(1)(2)GAC | K,M | 470 | 470 | 470 | 470 | 470 |
| 56 | C1632C560(1)(2)GAC | K,M | 560 | 560 | 560 | 560 | 560 |
| 68 | C1632C680(1)(2)GAC | K,M | 680 | 680 | 680 | 680 | 680 |
| 82 | C1632C820(1)(2)GAC | K,M | 820 | 820 | 820 | 820 | 820 |
| 100 | C1632C101(1)(2)GAC | K,M | 101 | 101 | 101 | 101 | 101 |
| 120 | C1632C121(1)(2)GAC | K,M | 121 | 121 | 121 | 121 | 121 |
| 150 | C1632C151(1)(2)GAC | K,M | 151 | 151 | 151 | 151 | 151 |
| 180 | C1632C181(1)(2)GAC | K,M | 181 | 181 | 181 | 181 | 181 |
| 220 | C1632C221(1)(2)GAC | K,M | 221 | 221 | 221 | 221 | 221 |
| 270 | C1632C271(1)(2)GAC | K,M | 271 | 271 | 271 | 271 | 271 |
| 330 | C1632C331(1)(2)GAC | K,M | 331 | 331 | 331 | 331 | 331 |
| 390 | C1632C391(1)(2)GAC | K,M | 391 | 391 | 391 | 391 | 391 |
| 470 | C1632C471(1)(2)GAC | K,M | 471 | 471 | 471 | 471 | 471 |

(1) To complete the KEMET part number, insert the alpha code for the tolerance desired.
K = ±10% and M = ±20% – standard tolerance. Contact factory for any special requirements.
(2) To complete the KEMET part number, insert appropriate number for voltage desired:
"5" = 50 volts, "3" = 25 volts, "4" = 16 volts, and "8" = 10 volts.

**TABLE 2B
X7R DIELECTRIC – CAPACITANCE RANGE**

| Capacitance Values (pF) | KEMET Part Number | Capacitance Tolerance | 10V 16V | 25V | 50V | 100V | 200V |
|-------------------------|--------------------|-----------------------|---------|-----|-----|------|------|
| 330 | C1632C331(1)(2)RAC | K,M | 331 | 331 | 331 | 331 | 331 |
| 390 | C1632C391(1)(2)RAC | K,M | 391 | 391 | 391 | 391 | 391 |
| 470 | C1632C471(1)(2)RAC | K,M | 471 | 471 | 471 | 471 | 471 |
| 560 | C1632C561(1)(2)RAC | K,M | 561 | 561 | 561 | 561 | 561 |
| 680 | C1632C681(1)(2)RAC | K,M | 681 | 681 | 681 | 681 | 681 |
| 820 | C1632C821(1)(2)RAC | K,M | 821 | 821 | 821 | 821 | 821 |
| 1000 | C1632C102(1)(2)RAC | K,M | 102 | 102 | 102 | 102 | 102 |
| 1200 | C1632C122(1)(2)RAC | K,M | 122 | 122 | 122 | 122 | 122 |
| 1500 | C1632C152(1)(2)RAC | K,M | 152 | 152 | 152 | 152 | 152 |
| 1800 | C1632C182(1)(2)RAC | K,M | 182 | 182 | 182 | 182 | 182 |
| 2200 | C1632C222(1)(2)RAC | K,M | 222 | 222 | 222 | 222 | 222 |
| 2700 | C1632C272(1)(2)RAC | K,M | 272 | 272 | 272 | 272 | 272 |
| 3300 | C1632C332(1)(2)RAC | K,M | 332 | 332 | 332 | 332 | 332 |
| 3900 | C1632C392(1)(2)RAC | K,M | 392 | 392 | 392 | 392 | 392 |
| 4700 | C1632C472(1)(2)RAC | K,M | 472 | 472 | 472 | 472 | 472 |
| 5600 | C1632C562(1)(2)RAC | K,M | 562 | 562 | 562 | 562 | 562 |
| 6800 | C1632C682(1)(2)RAC | K,M | 682 | 682 | 682 | 682 | 682 |
| 8200 | C1632C822(1)(2)RAC | K,M | 822 | 822 | 822 | 822 | 822 |
| 10,000 | C1632C103(1)(2)RAC | K,M | 103 | 103 | 103 | 103 | 103 |
| 12,000 | C1632C123(1)(2)RAC | K,M | 123 | 123 | 123 | 123 | 123 |
| 15,000 | C1632C153(1)(2)RAC | K,M | 153 | 153 | 153 | 153 | 153 |
| 18,000 | C1632C183(1)(2)RAC | K,M | 183 | 183 | 183 | 183 | 183 |
| 22,000 | C1632C223(1)(2)RAC | K,M | 223 | 223 | 223 | 223 | 223 |
| 27,000 | C1632C273(1)(2)RAC | K,M | 273 | 273 | 273 | 273 | 273 |
| 33,000 | C1632C333(1)(2)RAC | K,M | 333 | 333 | 333 | 333 | 333 |
| 39,000 | C1632C393(1)(2)RAC | K,M | 393 | 393 | 393 | 393 | 393 |
| 47,000 | C1632C473(1)(2)RAC | K,M | 473 | 473 | 473 | 473 | 473 |
| 56,000 | C1632C563(1)(2)RAC | K,M | 563 | 563 | 563 | 563 | 563 |
| 68,000 | C1632C683(1)(2)RAC | K,M | 683 | 683 | 683 | 683 | 683 |
| 82,000 | C1632C823(1)(2)RAC | K,M | 823 | 823 | 823 | 823 | 823 |
| 100,000 | C1632C104(1)(2)RAC | K,M | 104 | 104 | 104 | 104 | 104 |

(1) To complete the KEMET part number, insert the alpha code for the tolerance desired:
K = ±10% and M = ±20% – standard tolerances. Contact factory for any special requirements.
(2) To complete the KEMET part number, insert appropriate number for voltage desired:
"5" = 50 volts, "3" = 25 volts, "4" = 16 volts, and "8" = 10 volts.

**1632 CERAMIC ARRAY
LAND PATTERN LAYOUT**

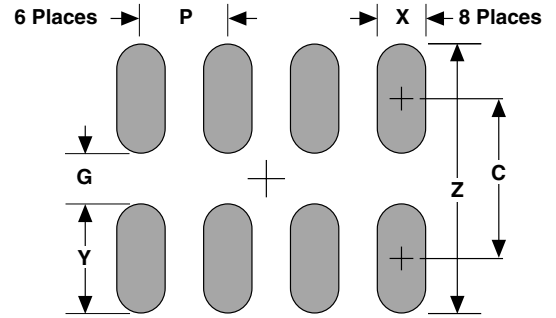

Additional pad dimension information is available in KEMET Technical Bulletin F-2100.

LAND PATTERN DIMENSIONS - CERAMIC CHIP CAPACITOR ARRAYS - MM

| Dimension | Reflow Solder | | | | | |
|-----------|---------------|------|------|--------|--------|--------|
| | Z | G | X | Y(ref) | C(ref) | P(ref) |
| 3216 | 2.80 | 0.40 | 0.52 | 1.20 | 1.60 | 0.80 |

Calculation Formula
 $Z = L_{min} + 2J_t + T_t$
 $G = S_{max} - 2J_h - T_h$
 $X = W_{min} + 2J_s + T_s$
 $T_t, T_h, T_s =$ Combined tolerances

CAPACITOR OUTLINE DRAWINGS

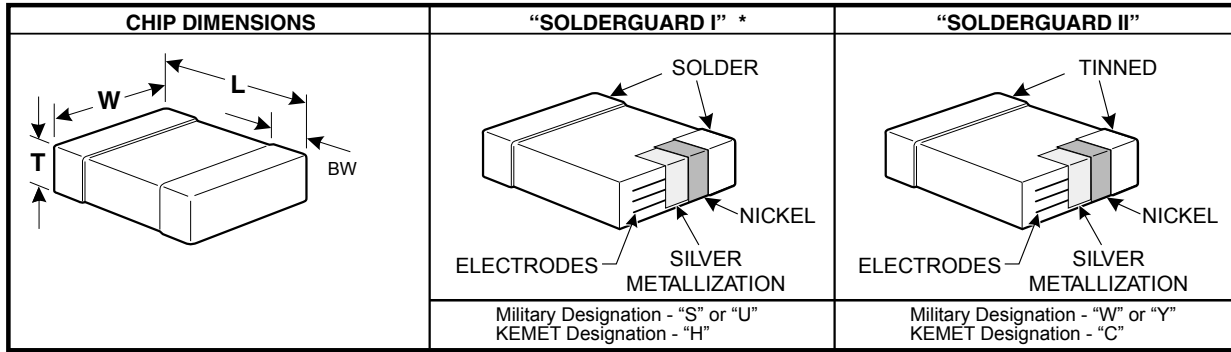

DIMENSIONS—MILLIMETERS AND (INCHES)

| STYLE | KEMET SIZE CODE | L | W | T | | BW |
|-------|-----------------|---|---|------------|-------------|-------------------------|
| | | | | MIN. | MAX. | |
| CDR01 | C0805 | 2.03 ±.38 (.080 ±.015) | 1.27 ±.38 (.050 ±.015) | .56 (.022) | 1.40 (.055) | .51 ± 0.25 (.020 ±.010) |
| CDR02 | C1805 | 4.57 ±.38 (.180 ±.015) | 1.27 ±.38 (.050 ±.015) | .56 (.022) | 1.40 (.055) | .51 ± 0.25 (.020 ±.010) |
| CDR03 | C1808 | 4.57 ±.38 (.180 ±.015) | 2.03 ±.38 (.080 ±.015) | .56 (.022) | 2.03 (.080) | .51 ± 0.25 (.020 ±.010) |
| CDR04 | C1812 | 4.57 ±.38 (.180 ±.015) | 3.18 ±.38 (.125 ±.015) | .56 (.022) | 2.03 (.080) | .51 ± 0.25 (.020 ±.010) |
| CDR05 | C1825 | 4.57 $\begin{pmatrix} +.51 & +.020 \\ .180 & \\ -.38 & -.015 \end{pmatrix}$ | 6.35 $\begin{pmatrix} +.51 & +.020 \\ .250 & \\ -.38 & -.015 \end{pmatrix}$ | .51 (.020) | 2.03 (.080) | .51 ± 0.25 (.020 ±.010) |
| CDR06 | C2225 | 5.72 ±.51 (.225 ±.020) | 6.35 ±.51 (.250 ±.020) | .51 (.020) | 2.03 (.080) | .51 ± 0.25 (.020 ±.010) |
| CDR31 | C0805 | 2.00 ±.20 (.078 ±.008) | 1.25 ±.20 (.049 ±.008) | | 1.30 (.051) | .50 ± 0.20 (.020 ±.008) |
| CDR32 | C1206 | 3.20 ±.20 (.125 ±.008) | 1.60 ±.20 (.062 ±.008) | | 1.30 (.051) | .50 ± 0.20 (.020 ±.008) |
| CDR33 | C1210 | 3.20 ±.25 (.125 ±.010) | 2.50 ±.25 (.098 ±.010) | | 1.50 (.059) | .50 ± 0.25 (.020 ±.010) |
| CDR34 | C1812 | 4.50 ±.25 (.176 ±.010) | 3.20 ±.25 (.125 ±.010) | | 1.50 (.059) | .50 ± 0.25 (.020 ±.010) |
| CDR35 | C1825 | 4.50 ±.30 (.176 ±.012) | 6.40 ±.30 (.250 ±.012) | | 1.50 (.059) | .50 ± 0.30 (.020 ±.012) |

Note: For SolderGuard I (MIL-C55681 "S" or "U" Endmets), the length, width and thickness positive tolerances (including bandwidth) cited above are allowed to increase by the following amounts:

| | Length | Width/Thickness |
|----------|---------------|-----------------|
| CDR01 | 0.51MM (.020) | 0.38MM (.015) |
| CDR02-06 | 0.64MM (.025) | 0.38MM (.015) |
| CDR31-35 | 0.60MM (.023) | 0.30MM (.012) |

MIL-PRF-55681 PART NUMBER ORDERING INFORMATION

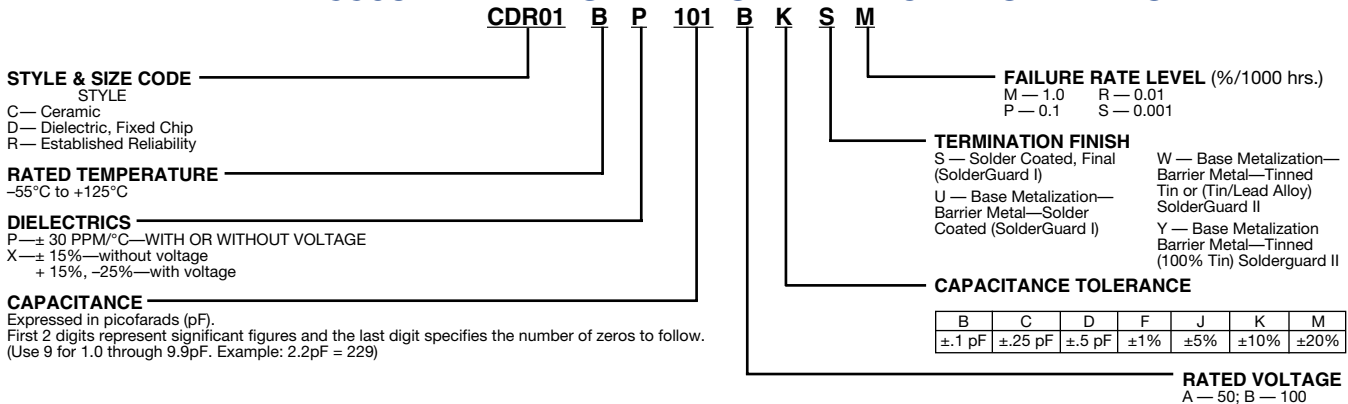

KEMET/MIL-PRF-55681 PART NUMBER EQUIVALENTS

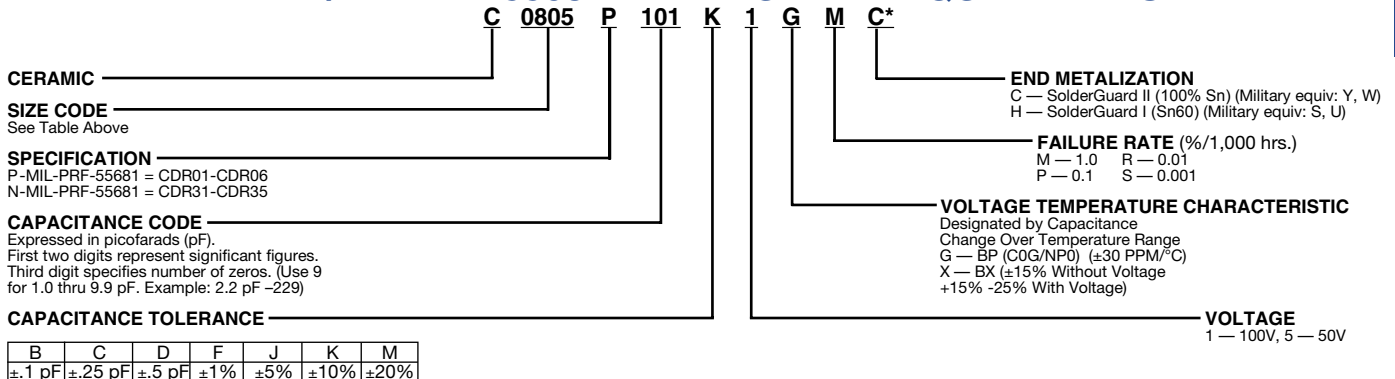

Ceramic Surface Mount

* Part Number Example: C0805P101K1GMC (14 digits - no spaces)

RATINGS & PART NUMBER REFERENCE

| CHARACTERISTIC | CAP. pF | AVAIL. TOL. | KEMET CAPACITORS | MIL-PRF-55681 PART NUMBER |
|---|--|--------------------|----------------------|---------------------------|
| 100 Volt — C0805 SIZE (MILITARY CDR01) | | | | |
| BP | 10 | J,K | C0805P100(3)1G(4)C | CDR01BP100B(3)W(4) |
| | 12 | J | C0805P120J1G(4)C | CDR01BP120BJW(4) |
| | 15 | J,K | C0805P150(3)1G(4)C | CDR01BP150B(3)W(4) |
| | 18 | J | C0805P180J1G(4)C | CDR01BP180BJW(4) |
| | 22 | J,K | C0805P220(3)1G(4)C | CDR01BP220B(3)W(4) |
| | 27 | J | C0805P270J1G(4)C | CDR01BP270BJW(4) |
| | 33 | J,K | C0805P330(3)1G(4)C | CDR01BP330B(3)W(4) |
| | 39 | J | C0805P390J1G(4)C | CDR01BP390BJW(4) |
| | 47 | J,K | C0805P470(3)1G(4)C | CDR01BP470B(3)W(4) |
| | 56 | J | C0805P560J1G(4)C | CDR01BP560BJW(4) |
| | 68 | J,K | C0805P680(3)1G(4)C | CDR01BP680B(3)W(4) |
| | 82 | J | C0805P820J1G(4)C | CDR01BP820BJW(4) |
| | 100 | J,K | C0805P101(3)1G(4)C | CDR01BP101B(3)W(4) |
| | BP or BX | 120 | J,K | C0805P121(3)1(2)(4)C |
| 150 | | J,K | C0805P151(3)1(2)(4)C | CDR01B(1)151B(3)W(4) |
| 180 | | J,K | C0805P181(3)1(2)(4)C | CDR01B(1)181B(3)W(4) |
| BX | 220 | K,M | C0805P221(3)1X(4)C | CDR01BX221B(3)W(4) |
| | 270 | K | C0805P271K1X(4)C | CDR01BX271BKW(4) |
| | 330 | K,M | C0805P331(3)1X(4)C | CDR01BX331B(3)W(4) |
| | 390 | K | C0805P391K1X(4)C | CDR01BX391BKW(4) |
| | 470 | K,M | C0805P471(3)1X(4)C | CDR01BX471B(3)W(4) |
| | 560 | K | C0805P561K1X(4)C | CDR01BX561BKW(4) |
| | 680 | K,M | C0805P681(3)1X(4)C | CDR01BX681B(3)W(4) |
| | 820 | K | C0805P821K1X(4)C | CDR01BX821BKW(4) |
| | 1,000 | K,M | C0805P102(3)1X(4)C | CDR01BX102B(3)W(4) |
| | 1,200 | K | C0805P122K1X(4)C | CDR01BX122BKW(4) |
| | 1,500 | K,M | C0805P152(3)1X(4)C | CDR01BX152B(3)W(4) |
| | 1,800 | K | C0805P182K1X(4)C | CDR01BX182BKW(4) |
| | 2,200 | K,M | C0805P222(3)1X(4)C | CDR01BX222B(3)W(4) |
| | 2,700 | K | C0805P272K1X(4)C | CDR01BX272BKW(4) |
| 3,300 | K,M | C0805P332(3)1X(4)C | CDR01BX332B(3)W(4) | |
| 50 Volt — C0805 SIZE (MILITARY CDR01) | | | | |
| BX | 3,900 | K | C0805P392K5X(4)C | CDR01BX392AKW(4) |
| | 4,700 | K,M | C0805P472(3)5X(4)C | CDR01BX472A(3)W(4) |
| 100 Volt — C1805 SIZE (MILITARY CDR02) | | | | |
| BP | 220 | J,K | C1805P221(3)1G(4)C | CDR02BP221B(3)W(4) |
| | 270 | J | C1805P271J1G(4)C | CDR02BP271BJW(4) |
| BX | 3,900 | K | C1805P392K1X(4)C | CDR02BX392BKW(4) |
| | 4,700 | K,M | C1805P472(3)1X(4)C | CDR02BX472B(3)W(4) |
| | 5,600 | K | C1805P562K1X(4)C | CDR02BX562BKW(4) |
| | 6,800 | K,M | C1805P682(3)1X(4)C | CDR02BX682B(3)W(4) |
| | 8,200 | K | C1805P822K1X(4)C | CDR02BX822BKW(4) |
| | 10,000 | K,M | C1805P103(3)1X(4)C | CDR02BX103B(3)W(4) |
| | 50 Volt — C1805 SIZE (MILITARY CDR02) | | | |
| BX | 12,000 | K | C1805P123K5X(4)C | CDR02BX123AKW(4) |
| | 15,000 | K,M | C1805P153(3)5X(4)C | CDR02BX153A(3)W(4) |
| | 18,000 | K | C1805P183K5X(4)C | CDR02BX183AKW(4) |
| | 22,000 | K,M | C1805P223(3)5X(4)C | CDR02BX223A(3)W(4) |
| 100 Volt — C1808 SIZE (MILITARY CDR03) | | | | |
| BP | 330 | J,K | C1808P331(3)1G(4)C | CDR03BP331B(3)W(4) |
| | 390 | J | C1808P391J1G(4)C | CDR03BP391BJW(4) |
| | 470 | J,K | C1808P471(3)1G(4)C | CDR03BP471B(3)W(4) |

| CHARACTERISTIC | CAP. pF | AVAIL. TOL. | KEMET CAPACITORS | MIL-PRF-55681 PART NUMBER |
|--|---------|--------------------|--------------------|---------------------------|
| 100 Volt — C1808 SIZE (MILITARY CDR03) (Cont'd) | | | | |
| BP | 560 | J | C1808P561J1G(4)C | CDR03BP561BJW(4) |
| | 680 | J,K | C1808P681(3)1G(4)C | CDR03BP681B(3)W(4) |
| | 820 | J | C1808P821J1G(4)C | CDR03BP821BJW(4) |
| BX | 1,000 | J,K | C1808P102(3)1G(4)C | CDR03BP102B(3)W(4) |
| | 12,000 | K | C1808P123K1X(4)C | CDR03BX123BKW(4) |
| | 15,000 | K,M | C1808P153(3)1X(4)C | CDR03BX153B(3)W(4) |
| | 18,000 | K | C1808P183K1X(4)C | CDR03BX183BKW(4) |
| | 22,000 | K,M | C1808P223(3)1X(4)C | CDR03BX223B(3)W(4) |
| | 27,000 | K | C1808P273K1X(4)C | CDR03BX273BKW(4) |
| 33,000 | K,M | C1808P333(3)1X(4)C | CDR03BX333B(3)W(4) | |
| 50 Volt — C1808 SIZE (MILITARY CDR03) | | | | |
| BX | 39,000 | K | C1808P393K5X(4)C | CDR03BX393AKW(4) |
| | 47,000 | K,M | C1808P473(3)5X(4)C | CDR03BX473A(3)W(4) |
| | 56,000 | K | C1808P563K5X(4)C | CDR03BX563AKW(4) |
| 68,000 | K,M | C1808P683(3)5X(4)C | CDR03BX683A(3)W(4) | |
| 100 Volt — C1812 SIZE (MILITARY CDR04) | | | | |
| BP | 1,200 | J | C1812P122J1G(4)C | CDR04BP122BJW(4) |
| | 1,500 | J,K | C1812P152(3)1G(4)C | CDR04BP152B(3)W(4) |
| | 1,800 | J | C1812P182J1G(4)C | CDR04BP182BJW(4) |
| | 2,200 | J,K | C1812P222(3)1G(4)C | CDR04BP222B(3)W(4) |
| | 2,700 | J | C1812P272J1G(4)C | CDR04BP272BJW(4) |
| | 3,300 | J,K | C1812P332(3)1G(4)C | CDR04BP332B(3)W(4) |
| BX | 39,000 | K | C1812P393K1X(4)C | CDR04BX393BKW(4) |
| | 47,000 | K,M | C1812P473(3)1X(4)C | CDR04BX473B(3)W(4) |
| | 56,000 | K | C1812P563K1X(4)C | CDR04BX563BKW(4) |
| 50 Volt — C1812 SIZE (MILITARY CDR04) | | | | |
| BX | 82,000 | K | C1812P823K5X(4)C | CDR04BX823AKW(4) |
| | 100,000 | K,M | C1812P104(3)5X(4)C | CDR04BX104A(3)W(4) |
| | 120,000 | K | C1812P124K5X(4)C | CDR04BX124AKW(4) |
| | 150,000 | K,M | C1812P154(3)5X(4)C | CDR04BX154A(3)W(4) |
| | 180,000 | K | C1812P184K5X(4)C | CDR04BX184AKW(4) |
| 100 Volt — C1825 SIZE (MILITARY CDR05) | | | | |
| BP | 3,900 | J,K | C1825P392(3)1G(4)C | CDR05BP392B(3)W(4) |
| | 4,700 | J,K | C1825P472(3)1G(4)C | CDR05BP472B(3)W(4) |
| | 5,600 | J,K | C1825P562(3)1G(4)C | CDR05BP562B(3)W(4) |
| BX | 68,000 | K,M | C1825P683(3)1X(4)C | CDR05BX683B(3)W(4) |
| | 82,000 | K | C1825P823K1X(4)C | CDR05BX823BKW(4) |
| | 100,000 | K,M | C1825P104(3)1X(4)C | CDR05BX104B(3)W(4) |
| | 120,000 | K | C1825P124K1X(4)C | CDR05BX124BKW(4) |
| | 150,000 | K,M | C1825P154(3)1X(4)C | CDR05BX154B(3)W(4) |
| 50 Volt — C1825 SIZE (MILITARY CDR05) | | | | |
| BX | 220,000 | K,M | C1825P224(3)5X(4)C | CDR05BX224A(3)W(4) |
| | 270,000 | K | C1825P274K5X(4)C | CDR05BX274AKW(4) |
| | 330,000 | K,M | C1825P334(3)5X(4)C | CDR05BX334A(3)W(4) |
| 100 Volt — C2225 SIZE (MILITARY CDR06) | | | | |
| BP | 6,800 | J,K | C2225P682(3)1G(4)C | CDR06BP682B(3)W(4) |
| | 8,200 | J,K | C2225P822(3)1G(4)C | CDR06BP822B(3)W(4) |
| | 10,000 | J,K | C2225P103(3)1G(4)C | CDR06BP103B(3)W(4) |
| 50 Volt — C2225 SIZE (MILITARY CDR06) | | | | |
| BX | 390,000 | K | C2225P394K5X(4)C | CDR06BX394AKW(4) |
| | 470,000 | K,M | C2225P474(3)5X(4)C | CDR06BX474A(3)W(4) |

- To complete Part Number for Dielectric, insert P or X symbol – as defined by Military specification.
- To complete Part Number for Dielectric, insert G or X symbol. (“G” for Military “BP,” or “X” for Military “BX.”)
- To complete Part Number, insert Capacitance Tolerance Symbol (when applicable) as available in MIL-PRF-55681: B – ±0.1 pF, C – ±0.25 pF, D – ±0.5pF, F – ±1%, J – ±5%, K – ±10%, M – ±20%. **NOTE: Available tolerances are listed in columns above.**
- To complete Part Number, insert Failure Rate Symbol: M –1.0%; P –0.1%; R –0.01%; S –.001%.

Note: All MIL-PRF-55681 and KEMET Part Numbers tabulated above assume use of Solderguard II (MIL-PRF-55681 “W”; KEMET “C”) end metalization. If MIL-PRF-55681 “U” or “S” (KEMET “H”) or MIL-PRF-55681 “Y” (KEMET “C”) is required, please change designators accordingly.

RATINGS & PART NUMBER REFERENCE

| CAP. pF | AVAIL. TOL. | KEMET CAPACITORS | MIL-PRF-55681 PART NUMBER |
|--|-------------|--------------------|---------------------------|
| 100 Volt — BP — C0805 SIZE (MILITARY CDR31) | | | |
| 1.0 | B,C | C0805N109(3)1G(4)C | CDR31BP1R0B(3)W(4) |
| 1.1 | B,C | C0805N119(3)1G(4)C | CDR31BP1R1B(3)W(4) |
| 1.2 | B,C | C0805N129(3)1G(4)C | CDR31BP1R2B(3)W(4) |
| 1.3 | B,C | C0805N139(3)1G(4)C | CDR31BP1R3B(3)W(4) |
| 1.5 | B,C | C0805N159(3)1G(4)C | CDR31BP1R5B(3)W(4) |
| 1.6 | B,C | C0805N169(3)1G(4)C | CDR31BP1R6B(3)W(4) |
| 1.8 | B,C | C0805N189(3)1G(4)C | CDR31BP1R8B(3)W(4) |
| 2.0 | B,C | C0805N209(3)1G(4)C | CDR31BP2R0B(3)W(4) |
| 2.2 | B,C | C0805N229(3)1G(4)C | CDR31BP2R2B(3)W(4) |
| 2.4 | B,C | C0805N249(3)1G(4)C | CDR31BP2R4B(3)W(4) |
| 2.7 | B,C,D | C0805N279(3)1G(4)C | CDR31BP2R7B(3)W(4) |
| 3.0 | B,C,D | C0805N309(3)1G(4)C | CDR31BP3R0B(3)W(4) |
| 3.3 | B,C,D | C0805N339(3)1G(4)C | CDR31BP3R3B(3)W(4) |
| 3.6 | B,C,D | C0805N369(3)1G(4)C | CDR31BP3R6B(3)W(4) |
| 3.9 | B,C,D | C0805N399(3)1G(4)C | CDR31BP3R9B(3)W(4) |
| 4.3 | B,C,D | C0805N439(3)1G(4)C | CDR31BP4R3B(3)W(4) |
| 4.7 | B,C,D | C0805N479(3)1G(4)C | CDR31BP4R7B(3)W(4) |
| 5.1 | B,C,D | C0805N519(3)1G(4)C | CDR31BP5R1B(3)W(4) |
| 5.6 | B,C,D | C0805N569(3)1G(4)C | CDR31BP5R6B(3)W(4) |
| 6.2 | B,C,D | C0805N629(3)1G(4)C | CDR31BP6R2B(3)W(4) |
| 6.8 | B,C,D | C0805N689(3)1G(4)C | CDR31BP6R8B(3)W(4) |
| 7.5 | B,C,D | C0805N759(3)1G(4)C | CDR31BP7R5B(3)W(4) |
| 8.2 | B,C,D | C0805N829(3)1G(4)C | CDR31BP8R2B(3)W(4) |
| 9.1 | B,C,D | C0805N919(3)1G(4)C | CDR31BP9R1B(3)W(4) |
| 10 | F,J,K | C0805N100(3)1G(4)C | CDR31BP100B(3)W(4) |
| 11 | F,J,K | C0805N110(3)1G(4)C | CDR31BP110B(3)W(4) |
| 12 | F,J,K | C0805N120(3)1G(4)C | CDR31BP120B(3)W(4) |
| 13 | F,J,K | C0805N130(3)1G(4)C | CDR31BP130B(3)W(4) |
| 15 | F,J,K | C0805N150(3)1G(4)C | CDR31BP150B(3)W(4) |
| 16 | F,J,K | C0805N160(3)1G(4)C | CDR31BP160B(3)W(4) |
| 18 | F,J,K | C0805N180(3)1G(4)C | CDR31BP180B(3)W(4) |
| 20 | F,J,K | C0805N200(3)1G(4)C | CDR31BP200B(3)W(4) |
| 22 | F,J,K | C0805N220(3)1G(4)C | CDR31BP220B(3)W(4) |
| 24 | F,J,K | C0805N240(3)1G(4)C | CDR31BP240B(3)W(4) |
| 27 | F,J,K | C0805N270(3)1G(4)C | CDR31BP270B(3)W(4) |
| 30 | F,J,K | C0805N300(3)1G(4)C | CDR31BP300B(3)W(4) |
| 33 | F,J,K | C0805N330(3)1G(4)C | CDR31BP330B(3)W(4) |
| 36 | F,J,K | C0805N360(3)1G(4)C | CDR31BP360B(3)W(4) |
| 39 | F,J,K | C0805N390(3)1G(4)C | CDR31BP390B(3)W(4) |
| 43 | F,J,K | C0805N430(3)1G(4)C | CDR31BP430B(3)W(4) |
| 47 | F,J,K | C0805N470(3)1G(4)C | CDR31BP470B(3)W(4) |
| 51 | F,J,K | C0805N510(3)1G(4)C | CDR31BP510B(3)W(4) |
| 56 | F,J,K | C0805N560(3)1G(4)C | CDR31BP560B(3)W(4) |
| 62 | F,J,K | C0805N620(3)1G(4)C | CDR31BP620B(3)W(4) |
| 68 | F,J,K | C0805N680(3)1G(4)C | CDR31BP680B(3)W(4) |
| 75 | F,J,K | C0805N750(3)1G(4)C | CDR31BP750B(3)W(4) |
| 82 | F,J,K | C0805N820(3)1G(4)C | CDR31BP820B(3)W(4) |

| CAP. pF | AVAIL. TOL. | KEMET CAPACITORS | MIL-PRF-55681 PART NUMBER |
|--|-------------|--------------------|---------------------------|
| 100 Volt — BP — C0805 SIZE (MILITARY CDR31) | | | |
| 91 | F,J,K | C0805N910(3)1G(4)C | CDR31BP910B(3)W(4) |
| 100 | F,J,K | C0805N101(3)1G(4)C | CDR31BP101B(3)W(4) |
| 110 | F,J,K | C0805N111(3)1G(4)C | CDR31BP111B(3)W(4) |
| 120 | F,J,K | C0805N121(3)1G(4)C | CDR31BP121B(3)W(4) |
| 130 | F,J,K | C0805N131(3)1G(4)C | CDR31BP131B(3)W(4) |
| 150 | F,J,K | C0805N151(3)1G(4)C | CDR31BP151B(3)W(4) |
| 160 | F,J,K | C0805N161(3)1G(4)C | CDR31BP161B(3)W(4) |
| 180 | F,J,K | C0805N181(3)1G(4)C | CDR31BP181B(3)W(4) |
| 200 | F,J,K | C0805N201(3)1G(4)C | CDR31BP201B(3)W(4) |
| 220 | F,J,K | C0805N221(3)1G(4)C | CDR31BP221B(3)W(4) |
| 240 | F,J,K | C0805N241(3)1G(4)C | CDR31BP241B(3)W(4) |
| 270 | F,J,K | C0805N271(3)1G(4)C | CDR31BP271B(3)W(4) |
| 300 | F,J,K | C0805N301(3)1G(4)C | CDR31BP301B(3)W(4) |
| 330 | F,J,K | C0805N331(3)1G(4)C | CDR31BP331B(3)W(4) |
| 360 | F,J,K | C0805N361(3)1G(4)C | CDR31BP361B(3)W(4) |
| 390 | F,J,K | C0805N391(3)1G(4)C | CDR31BP391B(3)W(4) |
| 430 | F,J,K | C0805N431(3)1G(4)C | CDR31BP431B(3)W(4) |
| 470 | F,J,K | C0805N471(3)1G(4)C | CDR31BP471B(3)W(4) |
| 50 Volt — BP — C0805 SIZE (MILITARY CDR31) | | | |
| 510 | F,J,K | C0805N511(3)5G(4)C | CDR31BP511A(3)W(4) |
| 560 | F,J,K | C0805N561(3)5G(4)C | CDR31BP561A(3)W(4) |
| 620 | F,J,K | C0805N621(3)5G(4)C | CDR31BP621A(3)W(4) |
| 680 | F,J,K | C0805N681(3)5G(4)C | CDR31BP681A(3)W(4) |
| 100 Volt — BX — C0805 SIZE (MILITARY CDR31) | | | |
| 470 | K,M | C0805N471(3)1X(4)C | CDR31BX471B(3)W(4) |
| 560 | K,M | C0805N561(3)1X(4)C | CDR31BX561B(3)W(4) |
| 680 | K,M | C0805N681(3)1X(4)C | CDR31BX681B(3)W(4) |
| 820 | K,M | C0805N821(3)1X(4)C | CDR31BX821B(3)W(4) |
| 1,000 | K,M | C0805N102(3)1X(4)C | CDR31BX102B(3)W(4) |
| 1,200 | K,M | C0805N122(3)1X(4)C | CDR31BX122B(3)W(4) |
| 1,500 | K,M | C0805N152(3)1X(4)C | CDR31BX152B(3)W(4) |
| 1,800 | K,M | C0805N182(3)1X(4)C | CDR31BX182B(3)W(4) |
| 2,200 | K,M | C0805N222(3)1X(4)C | CDR31BX222B(3)W(4) |
| 2,700 | K,M | C0805N272(3)1X(4)C | CDR31BX272B(3)W(4) |
| 3,300 | K,M | C0805N332(3)1X(4)C | CDR31BX332B(3)W(4) |
| 3,900 | K,M | C0805N392(3)1X(4)C | CDR31BX392B(3)W(4) |
| 4,700 | K,M | C0805N472(3)1X(4)C | CDR31BX472B(3)W(4) |
| 50 Volt — BX — C0805 SIZE (MILITARY CDR31) | | | |
| 5,600 | K,M | C0805N562(3)5X(4)C | CDR31BX562A(3)W(4) |
| 6,800 | K,M | C0805N682(3)5X(4)C | CDR31BX682A(3)W(4) |
| 8,200 | K,M | C0805N822(3)5X(4)C | CDR31BX822A(3)W(4) |
| 10,000 | K,M | C0805N103(3)5X(4)C | CDR31BX103A(3)W(4) |
| 12,000 | K,M | C0805N123(3)5X(4)C | CDR31BX123A(3)W(4) |
| 15,000 | K,M | C0805N153(3)5X(4)C | CDR31BX153A(3)W(4) |
| 18,000 | K,M | C0805N183(3)5X(4)C | CDR31BX183A(3)W(4) |

- (1) To complete Part Number for Dielectric, insert P or X symbol – as defined by Military specification.
- (2) To complete Part Number for Dielectric, insert G or X symbol. (“G” for Military “BP,” or “X” for Military “BX.”)
- (3) To complete Part Number, insert Capacitance Tolerance Symbol (when applicable) as available in MIL-PRF-55681: B – ±0.1 pF, C – ±0.25 pF, D – ±0.5pF, F – ±1%, J – ±5%, K – ±10%, M – ±20%. **NOTE: Available tolerances are listed in columns above.**
- (4) To complete Part Number, insert Failure Rate Symbol: M – 1.0%; P – 0.1%; R – 0.01%; S – .001%.

Note: All MIL-PRF-55681 and KEMET Part Numbers tabulated above assume use of Solderguard II (MIL-PRF-55681 “W”; KEMET “C”) end metal-ization. If MIL-PRF-55681 “U” or “S” (KEMET “H”) or MIL-PRF-55681 “Y” (KEMET “C”) is required, please change designators accordingly.

MARKING

See page 97 for MIL-PRF-55681 Marking

Ceramic Surface Mount

RATINGS & PART NUMBER REFERENCE

| CAP. pF | AVAIL. TOL. | KEMET CAPACITORS | MIL-PRF-55681 PART NUMBER |
|--|-------------|--------------------|---------------------------|
| 100 Volt — BP — C1206 SIZE (MILITARY CDR32) | | | |
| 1.0 | B,C | C1206N109(3)1G(4)C | CDR32BP1R0B(3)W(4) |
| 1.1 | B,C | C1206N119(3)1G(4)C | CDR32BP1R1B(3)W(4) |
| 1.2 | B,C | C1206N129(3)1G(4)C | CDR32BP1R2B(3)W(4) |
| 1.3 | B,C | C1206N139(3)1G(4)C | CDR32BP1R3B(3)W(4) |
| 1.5 | B,C | C1206N159(3)1G(4)C | CDR32BP1R5B(3)W(4) |
| 1.6 | B,C | C1206N169(3)1G(4)C | CDR32BP1R6B(3)W(4) |
| 1.8 | B,C | C1206N189(3)1G(4)C | CDR32BP1R8B(3)W(4) |
| 2.0 | B,C | C1206N209(3)1G(4)C | CDR32BP2R0B(3)W(4) |
| 2.2 | B,C | C1206N229(3)1G(4)C | CDR32BP2R2B(3)W(4) |
| 2.4 | B,C | C1206N249(3)1G(4)C | CDR32BP2R4B(3)W(4) |
| 2.7 | B,C,D | C1206N279(3)1G(4)C | CDR32BP2R7B(3)W(4) |
| 3.0 | B,C,D | C1206N309(3)1G(4)C | CDR32BP3R0B(3)W(4) |
| 3.3 | B,C,D | C1206N339(3)1G(4)C | CDR32BP3R3B(3)W(4) |
| 3.6 | B,C,D | C1206N369(3)1G(4)C | CDR32BP3R6B(3)W(4) |
| 3.9 | B,C,D | C1206N399(3)1G(4)C | CDR32BP3R9B(3)W(4) |
| 4.3 | B,C,D | C1206N439(3)1G(4)C | CDR32BP4R3B(3)W(4) |
| 4.7 | B,C,D | C1206N479(3)1G(4)C | CDR32BP4R7B(3)W(4) |
| 5.1 | B,C,D | C1206N519(3)1G(4)C | CDR32BP5R1B(3)W(4) |
| 5.6 | B,C,D | C1206N569(3)1G(4)C | CDR32BP5R6B(3)W(4) |
| 6.2 | B,C,D | C1206N629(3)1G(4)C | CDR32BP6R2B(3)W(4) |
| 6.8 | B,C,D | C1206N689(3)1G(4)C | CDR32BP6R8B(3)W(4) |
| 7.5 | B,C,D | C1206N759(3)1G(4)C | CDR32BP7R5B(3)W(4) |
| 8.2 | B,C,D | C1206N829(3)1G(4)C | CDR32BP8R2B(3)W(4) |
| 9.1 | B,C,D | C1206N919(3)1G(4)C | CDR32BP9R1B(3)W(4) |
| 10 | F,J,K | C1206N100(3)1G(4)C | CDR32BP100B(3)W(4) |
| 11 | F,J,K | C1206N110(3)1G(4)C | CDR32BP110B(3)W(4) |
| 12 | F,J,K | C1206N120(3)1G(4)C | CDR32BP120B(3)W(4) |
| 13 | F,J,K | C1206N130(3)1G(4)C | CDR32BP130B(3)W(4) |
| 15 | F,J,K | C1206N150(3)1G(4)C | CDR32BP150B(3)W(4) |
| 16 | F,J,K | C1206N160(3)1G(4)C | CDR32BP160B(3)W(4) |
| 18 | F,J,K | C1206N180(3)1G(4)C | CDR32BP180B(3)W(4) |
| 20 | F,J,K | C1206N200(3)1G(4)C | CDR32BP200B(3)W(4) |
| 22 | F,J,K | C1206N220(3)1G(4)C | CDR32BP220B(3)W(4) |
| 24 | F,J,K | C1206N240(3)1G(4)C | CDR32BP240B(3)W(4) |
| 27 | F,J,K | C1206N270(3)1G(4)C | CDR32BP270B(3)W(4) |
| 30 | F,J,K | C1206N300(3)1G(4)C | CDR32BP300B(3)W(4) |
| 33 | F,J,K | C1206N330(3)1G(4)C | CDR32BP330B(3)W(4) |
| 36 | F,J,K | C1206N360(3)1G(4)C | CDR32BP360B(3)W(4) |
| 39 | F,J,K | C1206N390(3)1G(4)C | CDR32BP390B(3)W(4) |
| 43 | F,J,K | C1206N430(3)1G(4)C | CDR32BP430B(3)W(4) |
| 47 | F,J,K | C1206N470(3)1G(4)C | CDR32BP470B(3)W(4) |
| 51 | F,J,K | C1206N510(3)1G(4)C | CDR32BP510B(3)W(4) |
| 56 | F,J,K | C1206N560(3)1G(4)C | CDR32BP560B(3)W(4) |
| 62 | F,J,K | C1206N620(3)1G(4)C | CDR32BP620B(3)W(4) |
| 68 | F,J,K | C1206N680(3)1G(4)C | CDR32BP680B(3)W(4) |
| 75 | F,J,K | C1206N750(3)1G(4)C | CDR32BP750B(3)W(4) |
| 82 | F,J,K | C1206N820(3)1G(4)C | CDR32BP820B(3)W(4) |
| 91 | F,J,K | C1206N910(3)1G(4)C | CDR32BP910B(3)W(4) |
| 100 | F,J,K | C1206N101(3)1G(4)C | CDR32BP101B(3)W(4) |

| CAP. pF | AVAIL. TOL. | KEMET CAPACITORS | MIL-PRF-55681 PART NUMBER |
|--|-------------|--------------------|---------------------------|
| 100 Volt — BP — C1206 SIZE (MILITARY CDR32) | | | |
| 110 | F,J,K | C1206N111(3)1G(4)C | CDR32BP111B(3)W(4) |
| 120 | F,J,K | C1206N121(3)1G(4)C | CDR32BP121B(3)W(4) |
| 130 | F,J,K | C1206N131(3)1G(4)C | CDR32BP131B(3)W(4) |
| 150 | F,J,K | C1206N151(3)1G(4)C | CDR32BP151B(3)W(4) |
| 160 | F,J,K | C1206N161(3)1G(4)C | CDR32BP161B(3)W(4) |
| 180 | F,J,K | C1206N181(3)1G(4)C | CDR32BP181B(3)W(4) |
| 200 | F,J,K | C1206N201(3)1G(4)C | CDR32BP201B(3)W(4) |
| 220 | F,J,K | C1206N221(3)1G(4)C | CDR32BP221B(3)W(4) |
| 240 | F,J,K | C1206N241(3)1G(4)C | CDR32BP241B(3)W(4) |
| 270 | F,J,K | C1206N271(3)1G(4)C | CDR32BP271B(3)W(4) |
| 300 | F,J,K | C1206N301(3)1G(4)C | CDR32BP301B(3)W(4) |
| 330 | F,J,K | C1206N331(3)1G(4)C | CDR32BP331B(3)W(4) |
| 360 | F,J,K | C1206N361(3)1G(4)C | CDR32BP361B(3)W(4) |
| 390 | F,J,K | C1206N391(3)1G(4)C | CDR32BP391B(3)W(4) |
| 430 | F,J,K | C1206N431(3)1G(4)C | CDR32BP431B(3)W(4) |
| 470 | F,J,K | C1206N471(3)1G(4)C | CDR32BP471B(3)W(4) |
| 510 | F,J,K | C1206N511(3)1G(4)C | CDR32BP511B(3)W(4) |
| 560 | F,J,K | C1206N561(3)1G(4)C | CDR32BP561B(3)W(4) |
| 620 | F,J,K | C1206N621(3)1G(4)C | CDR32BP621B(3)W(4) |
| 680 | F,J,K | C1206N681(3)1G(4)C | CDR32BP681B(3)W(4) |
| 750 | F,J,K | C1206N751(3)1G(4)C | CDR32BP751B(3)W(4) |
| 820 | F,J,K | C1206N821(3)1G(4)C | CDR32BP821B(3)W(4) |
| 910 | F,J,K | C1206N911(3)1G(4)C | CDR32BP911B(3)W(4) |
| 1,000 | F,J,K | C1206N102(3)1G(4)C | CDR32BP102B(3)W(4) |
| 50 Volt — BP — C1206 SIZE (MILITARY CDR32) | | | |
| 1,100 | F,J,K | C1206N112(3)5G(4)C | CDR32BP112A(3)W(4) |
| 1,200 | F,J,K | C1206N122(3)5G(4)C | CDR32BP122A(3)W(4) |
| 1,300 | F,J,K | C1206N132(3)5G(4)C | CDR32BP132A(3)W(4) |
| 1,500 | F,J,K | C1206N152(3)5G(4)C | CDR32BP152A(3)W(4) |
| 1,600 | F,J,K | C1206N162(3)5G(4)C | CDR32BP162A(3)W(4) |
| 1,800 | F,J,K | C1206N182(3)5G(4)C | CDR32BP182A(3)W(4) |
| 2,000 | F,J,K | C1206N202(3)5G(4)C | CDR32BP202A(3)W(4) |
| 2,200 | F,J,K | C1206N222(3)5G(4)C | CDR32BP222A(3)W(4) |
| 100 Volt — BX — C1206 SIZE (MILITARY CDR32) | | | |
| 4,700 | K,M | C1206N472(3)1X(4)C | CDR32BX472B(3)W(4) |
| 5,600 | K,M | C1206N562(3)1X(4)C | CDR32BX562B(3)W(4) |
| 6,800 | K,M | C1206N682(3)1X(4)C | CDR32BX682B(3)W(4) |
| 8,200 | K,M | C1206N822(3)1X(4)C | CDR32BX822B(3)W(4) |
| 10,000 | K,M | C1206N103(3)1X(4)C | CDR32BX103B(3)W(4) |
| 12,000 | K,M | C1206N123(3)1X(4)C | CDR32BX123B(3)W(4) |
| 15,000 | K,M | C1206N153(3)1X(4)C | CDR32BX153B(3)W(4) |
| 50 Volt — BX — C1206 SIZE (MILITARY CDR32) | | | |
| 18,000 | K,M | C1206N183(3)5X(4)C | CDR32BX183A(3)W(4) |
| 22,000 | K,M | C1206N223(3)5X(4)C | CDR32BX223A(3)W(4) |
| 27,000 | K,M | C1206N273(3)5X(4)C | CDR32BX273A(3)W(4) |
| 33,000 | K,M | C1206N333(3)5X(4)C | CDR32BX333A(3)W(4) |
| 39,000 | K,M | C1206N393(3)5X(4)C | CDR32BX393A(3)W(4) |

- To complete Part Number for Dielectric, insert P or X symbol – as defined by Military specification.
- To complete Part Number for Dielectric, insert G or X symbol. (“G” for Military “BP,” or “X” for Military “BX.”)
- To complete Part Number, insert Capacitance Tolerance Symbol (when applicable) as available in MIL-PRF-55681: B – ±0.1 pF, C – ±0.25 pF, D – ±0.5pF, F – ±1%, J – ±5%, K – ±10%, M – ±20%. **NOTE: Available tolerances are listed in columns above.**
- To complete Part Number, insert Failure Rate Symbol: M –1.0%; P –0.1%; R –0.01%; S –.001%.

Note: All MIL-PRF-55681 and KEMET Part Numbers tabulated above assume use of Solderguard II (MIL-PRF-55681 “W”; KEMET “C”) end metalization. If MIL-PRF-55681 “U” or “S” (KEMET “H”) or MIL-PRF-55681 “Y” (KEMET “C”) is required, please change designators accordingly.

RATINGS & PART NUMBER REFERENCE

| CAP. pF | AVAIL. TOL. | KEMET CAPACITORS | MIL-PRF-55681 PART NUMBER |
|--|-------------|--------------------|---------------------------|
| 100 Volt — BP — C1210 SIZE (MILITARY CDR33) | | | |
| 1,000 | F,J,K | C1210N102(3)1G(4)C | CDR33BP102B(3)W(4) |
| 1,100 | F,J,K | C1210N112(3)1G(4)C | CDR33BP112B(3)W(4) |
| 1,200 | F,J,K | C1210N122(3)1G(4)C | CDR33BP122B(3)W(4) |
| 1,300 | F,J,K | C1210N132(3)1G(4)C | CDR33BP132B(3)W(4) |
| 1,500 | F,J,K | C1210N152(3)1G(4)C | CDR33BP152B(3)W(4) |
| 1,600 | F,J,K | C1210N162(3)1G(4)C | CDR33BP162B(3)W(4) |
| 1,800 | F,J,K | C1210N182(3)1G(4)C | CDR33BP182B(3)W(4) |
| 2,000 | F,J,K | C1210N202(3)1G(4)C | CDR33BP202B(3)W(4) |
| 2,200 | F,J,K | C1210N222(3)1G(4)C | CDR33BP222B(3)W(4) |
| 50 Volt — BP — C1210 SIZE (MILITARY CDR33) | | | |
| 2,400 | F,J,K | C1210N242(3)5G(4)C | CDR33BP242A(3)W(4) |
| 2,700 | F,J,K | C1210N272(3)5G(4)C | CDR33BP272A(3)W(4) |
| 3,000 | F,J,K | C1210N302(3)5G(4)C | CDR33BP302A(3)W(4) |
| 3,300 | F,J,K | C1210N332(3)5G(4)C | CDR33BP332A(3)W(4) |
| 100 Volt — BX — C1210 SIZE (MILITARY CDR33) | | | |
| 15,000 | K,M | C1210N153(3)1X(4)C | CDR33BX153B(3)W(4) |
| 18,000 | K,M | C1210N183(3)1X(4)C | CDR33BX183B(3)W(4) |
| 22,000 | K,M | C1210N223(3)1X(4)C | CDR33BX223B(3)W(4) |
| 27,000 | K,M | C1210N273(3)1X(4)C | CDR33BX273B(3)W(4) |
| 50 Volt — BX — C1210 SIZE (MILITARY CDR33) | | | |
| 39,000 | K,M | C1210N393(3)5X(4)C | CDR33BX393A(3)W(4) |
| 47,000 | K,M | C1210N473(3)5X(4)C | CDR33BX473A(3)W(4) |
| 56,000 | K,M | C1210N563(3)5X(4)C | CDR33BX563A(3)W(4) |
| 68,000 | K,M | C1210N683(3)5X(4)C | CDR33BX683A(3)W(4) |
| 82,000 | K,M | C1210N823(3)5X(4)C | CDR33BX823A(3)W(4) |
| 100,000 | K,M | C1210N104(3)5X(4)C | CDR33BX104A(3)W(4) |
| 100 Volt — BP — C1812 SIZE (MILITARY CDR34) | | | |
| 2,200 | F,J,K | C1812N222(3)1G(4)C | CDR34BP222B(3)W(4) |
| 2,400 | F,J,K | C1812N242(3)1G(4)C | CDR34BP242B(3)W(4) |
| 2,700 | F,J,K | C1812N272(3)1G(4)C | CDR34BP272B(3)W(4) |
| 3,000 | F,J,K | C1812N302(3)1G(4)C | CDR34BP302B(3)W(4) |
| 3,300 | F,J,K | C1812N332(3)1G(4)C | CDR34BP332B(3)W(4) |
| 3,600 | F,J,K | C1812N362(3)1G(4)C | CDR34BP362B(3)W(4) |
| 3,900 | F,J,K | C1812N392(3)1G(4)C | CDR34BP392B(3)W(4) |
| 4,300 | F,J,K | C1812N432(3)1G(4)C | CDR34BP432B(3)W(4) |
| 4,700 | F,J,K | C1812N472(3)1G(4)C | CDR34BP472B(3)W(4) |
| 50 Volt — BP — C1812 SIZE (MILITARY CDR34) | | | |
| 5,100 | F,J,K | C1812N512(3)5G(4)C | CDR34BP512A(3)W(4) |
| 5,600 | F,J,K | C1812N562(3)5G(4)C | CDR34BP562A(3)W(4) |
| 6,200 | F,J,K | C1812N622(3)5G(4)C | CDR34BP622A(3)W(4) |
| 6,800 | F,J,K | C1812N682(3)5G(4)C | CDR34BP682A(3)W(4) |
| 7,500 | F,J,K | C1812N752(3)5G(4)C | CDR34BP752A(3)W(4) |
| 8,200 | F,J,K | C1812N822(3)5G(4)C | CDR34BP822A(3)W(4) |
| 9,100 | F,J,K | C1812N912(3)5G(4)C | CDR34BP912A(3)W(4) |
| 10,000 | F,J,K | C1812N103(3)5G(4)C | CDR34BP103A(3)W(4) |

| CAP. pF | AVAIL. TOL. | KEMET CAPACITORS | MIL-PRF-55681 PART NUMBER |
|--|-------------|--------------------|---------------------------|
| 100 Volt — BX — C1812 SIZE (MILITARY CDR34) | | | |
| 27,000 | K,M | C1812N273(3)1X(4)C | CDR34BX273B(3)W(4) |
| 33,000 | K,M | C1812N333(3)1X(4)C | CDR34BX333B(3)W(4) |
| 39,000 | K,M | C1812N393(3)1X(4)C | CDR34BX393B(3)W(4) |
| 47,000 | K,M | C1812N473(3)1X(4)C | CDR34BX473B(3)W(4) |
| 56,000 | K,M | C1812N563(3)1X(4)C | CDR34BX563B(3)W(4) |
| 50 Volt — BX — C1812 SIZE (MILITARY CDR34) | | | |
| 100,000 | K,M | C1812N104(3)5X(4)C | CDR34BX104A(3)W(4) |
| 120,000 | K,M | C1812N124(3)5X(4)C | CDR34BX124A(3)W(4) |
| 150,000 | K,M | C1812N154(3)5X(4)C | CDR34BX154A(3)W(4) |
| 180,000 | K,M | C1812N184(3)5X(4)C | CDR34BX184A(3)W(4) |
| 100 Volt — BP — C1825 SIZE (MILITARY CDR35) | | | |
| 4,700 | F,J,K | C1825N472(3)1G(4)C | CDR35BP472B(3)W(4) |
| 5,100 | F,J,K | C1825N512(3)1G(4)C | CDR35BP512B(3)W(4) |
| 5,600 | F,J,K | C1825N562(3)1G(4)C | CDR35BP562B(3)W(4) |
| 6,200 | F,J,K | C1825N622(3)1G(4)C | CDR35BP622B(3)W(4) |
| 6,800 | F,J,K | C1825N682(3)1G(4)C | CDR35BP682B(3)W(4) |
| 7,500 | F,J,K | C1825N752(3)1G(4)C | CDR35BP752B(3)W(4) |
| 8,200 | F,J,K | C1825N822(3)1G(4)C | CDR35BP822B(3)W(4) |
| 9,100 | F,J,K | C1825N912(3)1G(4)C | CDR35BP912B(3)W(4) |
| 10,000 | F,J,K | C1825N103(3)1G(4)C | CDR35BP103B(3)W(4) |
| 50 Volt — BP — C1825 SIZE (MILITARY CDR35) | | | |
| 11,000 | F,J,K | C1825N113(3)5G(4)C | CDR35BP113A(3)W(4) |
| 12,000 | F,J,K | C1825N123(3)5G(4)C | CDR35BP123A(3)W(4) |
| 13,000 | F,J,K | C1825N133(3)5G(4)C | CDR35BP133A(3)W(4) |
| 15,000 | F,J,K | C1825N153(3)5G(4)C | CDR35BP153A(3)W(4) |
| 16,000 | F,J,K | C1825N163(3)5G(4)C | CDR35BP163A(3)W(4) |
| 18,000 | F,J,K | C1825N183(3)5G(4)C | CDR35BP183A(3)W(4) |
| 20,000 | F,J,K | C1825N203(3)5G(4)C | CDR35BP203A(3)W(4) |
| 22,000 | F,J,K | C1825N223(3)5G(4)C | CDR35BP223A(3)W(4) |
| 100 Volt — BX — C1825 SIZE (MILITARY CDR35) | | | |
| 56,000 | K,M | C1825N563(3)1X(4)C | CDR35BX563B(3)W(4) |
| 68,000 | K,M | C1825N683(3)1X(4)C | CDR35BX683B(3)W(4) |
| 82,000 | K,M | C1825N823(3)1X(4)C | CDR35BX823B(3)W(4) |
| 100,000 | K,M | C1825N104(3)1X(4)C | CDR35BX104B(3)W(4) |
| 120,000 | K,M | C1825N124(3)1X(4)C | CDR35BX124B(3)W(4) |
| 150,000 | K,M | C1825N154(3)1X(4)C | CDR35BX154B(3)W(4) |
| 50 Volt — BX — C1825 SIZE (MILITARY CDR35) | | | |
| 180,000 | K,M | C1825N184(3)5X(4)C | CDR35BX184A(3)W(4) |
| 220,000 | K,M | C1825N224(3)5X(4)C | CDR35BX224A(3)W(4) |
| 270,000 | K,M | C1825N274(3)5X(4)C | CDR35BX274A(3)W(4) |
| 330,000 | K,M | C1825N334(3)5X(4)C | CDR35BX334A(3)W(4) |
| 390,000 | K,M | C1825N394(3)5X(4)C | CDR35BX394A(3)W(4) |
| 470,000 | K,M | C1825N474(3)5X(4)C | CDR35BX474A(3)W(4) |

- To complete Part Number for Dielectric, insert P or X symbol – as defined by Military specification.
- To complete Part Number for Dielectric, insert G or X symbol. (“G” for Military “BP,” or “X” for Military “BX.”)
- To complete Part Number, insert Capacitance Tolerance Symbol (when applicable) as available in MIL-PRF-55681: B – ±0.1 pF, C – ±0.25 pF, D – ±0.5pF, F – ±1%, J – ±5%, K – ±10%, M – ±20%. **NOTE: Available tolerances are listed in columns above.**
- To complete Part Number, insert Failure Rate Symbol: M –1.0%; P –0.1%; R –0.01%; S –.001%.

Note: All MIL-PRF-55681 and KEMET Part Numbers tabulated above assume use of Solderguard II (MIL-PRF-55681 “W”; KEMET “C”) end metal-ization. If MIL-PRF-55681 “U” or “S” (KEMET “H”) or MIL-PRF-55681 “Y” (KEMET “C”) is required, please change designators accordingly.

MIL-PRF-55681 MAXIMUM INDIVIDUAL PACKAGING QUANTITIES

| CHIP SIZE | BULK - | | | CHIP SIZE | BULK - | | |
|-----------|--------|---------|-----------------|-----------|--------|---------|-----------------|
| | REELED | STD BAG | ANTI-STATIC BAG | | REELED | STD BAG | ANTI-STATIC BAG |
| C0805 | 2,500 | 25,000 | 10,000 | C1808 | 2,500 | 7,500 | 3,000 |
| C1206 | 2,500 | 25,000 | 10,000 | C1812 | 1,100 | 7,500 | 3,000 |
| C1210 | 2,500 | 25,000 | 10,000 | C1825 | 1,100 | 7,500 | 1,000 |
| C1805 | 2,500 | 7,500 | 3,000 | C2225 | 1,100 | 5,000 | 1,000 |

MIL-PRF-55681 chips available in 7" reels only.

Tape & Reel Packaging

KEMET offers Multilayer Ceramic Chip Capacitors packaged in 8mm and 12mm plastic tape on 7" and 13" reels in accordance with EIA standard 481-1: Taping of surface mount components for automatic handling. This packaging system is compatible with all tape fed automatic pick and place systems. See page 78 for details on reeling quantities for commercial chips and page 87 for MIL-PRF-55681 chips.

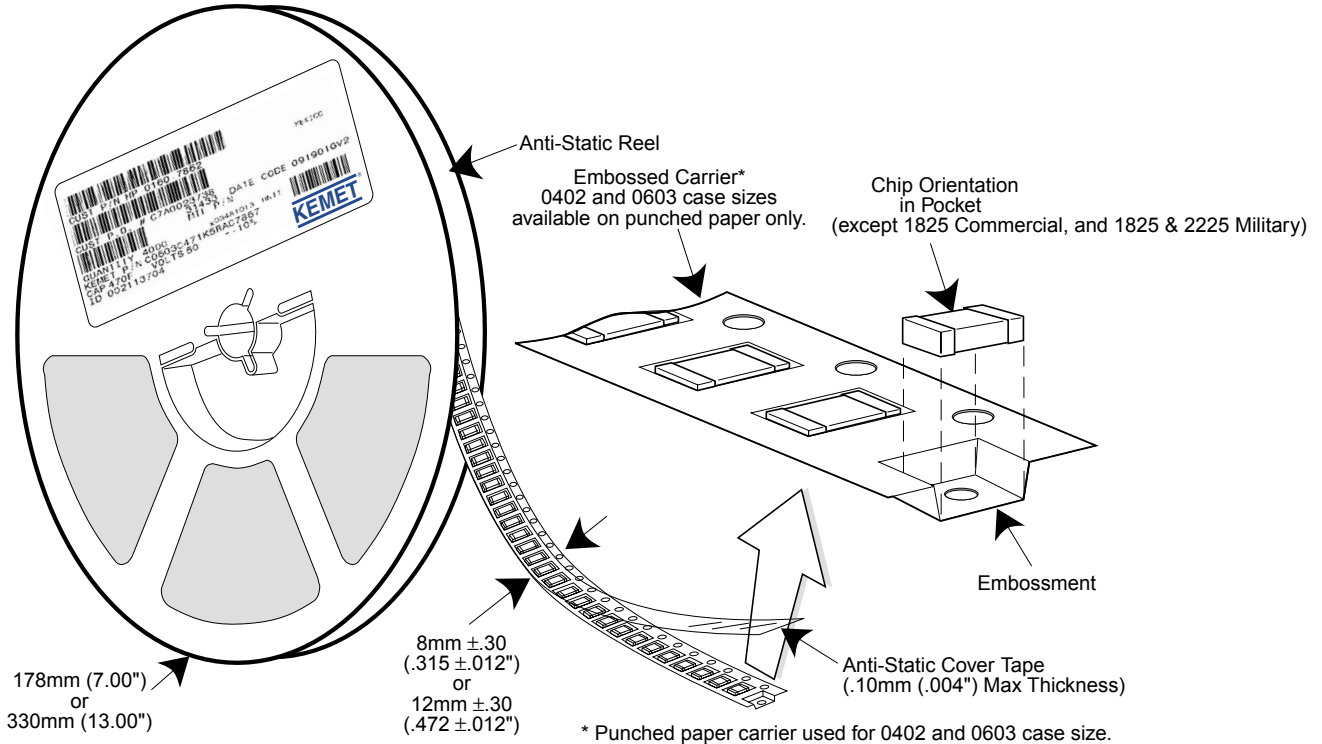

SURFACE MOUNT LAND DIMENSIONS - CERAMIC CHIP CAPACITORS - MM

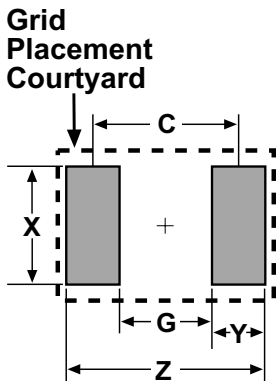

| Dimension | Reflow Solder | | | | | Wave Solder | | | | |
|-----------|---------------|------|------|--------|--------|-----------------|------|------|--------|------|
| | Z | G | X | Y(ref) | C(ref) | Z | G | X | Y(ref) | Smin |
| 0402 | 2.14 | 0.28 | 0.74 | 0.93 | 1.21 | Not Recommended | | | | |
| 0603 | 2.78 | 0.68 | 1.08 | 1.05 | 1.73 | 3.18 | 0.68 | 0.80 | 1.25 | 1.93 |
| 0805 | 3.30 | 0.70 | 1.60 | 1.30 | 2.00 | 3.70 | 0.70 | 1.10 | 1.50 | 2.20 |
| 1206 | 4.50 | 1.50 | 2.00 | 1.50 | 3.00 | 4.90 | 1.50 | 1.40 | 1.70 | 3.20 |
| 1210 | 4.50 | 1.50 | 2.90 | 1.50 | 3.00 | 4.90 | 1.50 | 2.00 | 1.70 | 3.20 |
| 1812 | 5.90 | 2.30 | 3.70 | 1.80 | 4.10 | Not Recommended | | | | |
| 1825 | 5.90 | 2.30 | 6.90 | 1.80 | 4.10 | | | | | |
| 2220 | 7.00 | 3.30 | 5.50 | 1.85 | 5.15 | | | | | |
| 2225 | 7.00 | 3.30 | 6.80 | 1.85 | 5.15 | | | | | |

Calculation Formula
 $Z = Lmin + 2Jt + Tt$
 $G = Smax - 2Jh - Th$
 $X = Wmin + 2Js + Ts$
 Tt, Th, Ts = Combined tolerances

TANTALUM, CERAMIC AND ALUMINUM CHIP CAPACITORS

Packaging Information

Performance Notes

- Cover Tape Break Force:** 1.0 Kg Minimum.
- Cover Tape Peel Strength:** The total peel strength of the cover tape from the carrier tape shall be:

| Tape Width | Peel Strength |
|------------|--|
| 8 mm | 0.1 Newton to 1.0 Newton (10g to 100g) |
| 12 mm | 0.1 Newton to 1.3 Newton (10g to 130g) |

The direction of the pull shall be opposite the direction of the carrier tape travel. The pull angle of the carrier tape shall be 165° to 180° from the plane of the carrier tape. During peeling, the carrier and/or cover tape shall be pulled at a velocity of 300 ±10 mm/minute.

- Reel Sizes:** Molded tantalum capacitors are available on either 180 mm (7") reels (standard) or 330 mm (13") reels (with C-7280). Note that 13" reels are preferred.
- Labeling:** Bar code labeling (standard or custom) shall be on the side of the reel opposite the sprocket holes. Refer to EIA-556.

Embossed Carrier Tape Configuration: Figure 1

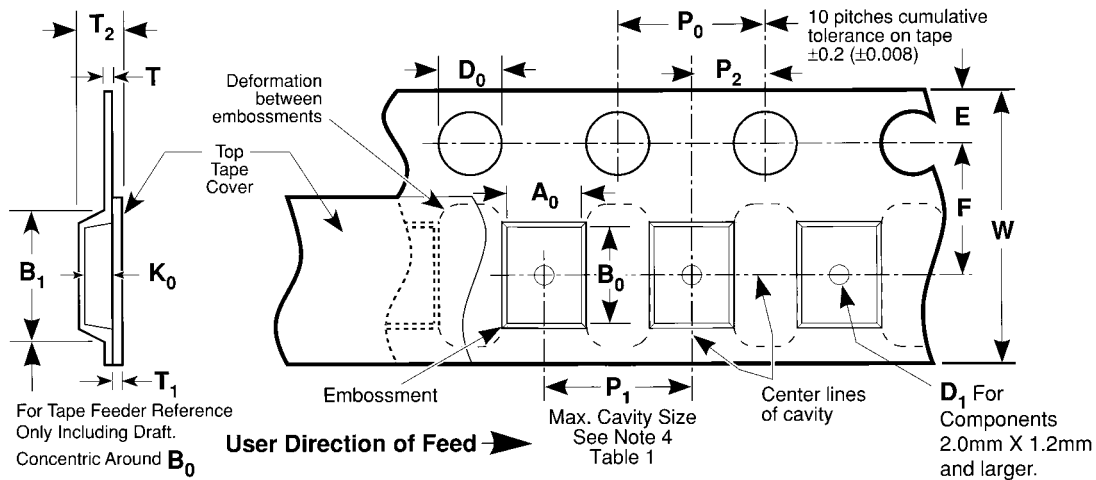

Table 1 — EMBOSSED TAPE DIMENSIONS (Metric will govern)

| Constant Dimensions — Millimeters (Inches) | | | | | | | | | |
|--|--|-------------------------------|-------------------------------|-----------------------------|-----------------------------|--------------------|--------------------|------------------------------|--|
| Tape Size | D ₀ | E | P ₀ | P ₂ | T Max | T ₁ Max | | | |
| 8 mm and 12 mm | 1.5 +0.10 -0.0 (0.059 +0.004, -0.0) | 1.75 ±0.10 (0.069 ±0.004) | 4.0 ±0.10 (0.157 ±0.004) | 2.0 ±0.05 (0.079 ±0.002) | 0.600 (0.024) | 0.100 (0.004) | | | |
| Variable Dimensions — Millimeters (Inches) | | | | | | | | | |
| Tape Size | Pitch | B ₁ Max. Note 1 | D ₁ Min. Note 2 | F | P ₁ | R Min. Note 3 | T ₂ Max | W | A ₀ B ₀ K ₀ Note 4 |
| 8 mm | Single (4 mm) | 4.4 (0.173) | 1.0 (0.039) | 3.5 ±0.05 (0.138 ±0.002) | 4.0 ±0.10 (0.157 ±0.004) | 25.0 (0.984) | 2.5 (0.098) | 8.0 ±0.30 (.315 ±0.012) | |
| 12 mm | Double (8 mm) | 8.2 (0.323) | 1.5 (0.059) | 5.5 ±0.05 (0.217 ±0.002) | 8.0 ±0.10 (0.315 ±0.004) | 30.0 (1.181) | 4.6 (0.181) | 12.0 ±0.30 (0.472 ±0.012) | |

NOTES

- B₁ dimension is a reference dimension for tape feeder clearance only.
- The embossment hole location shall be measured from the sprocket hole controlling the location of the embossment. Dimensions of embossment location and hole location shall be applied independent of each other.
- Tape with components shall pass around radius "R" without damage (see sketch A). The minimum trailer length (Fig. 2) may require additional length to provide R min. for 12 mm embossed tape for reels with hub diameters approaching N min. (Table 2)
- The cavity defined by A₀, B₀, and K₀ shall be configured to surround the part with sufficient clearance such that the chip does not protrude beyond the sealing plane of the cover tape, the chip can be removed from the cavity in a vertical direction without mechanical restriction, rotation of the chip is limited to 20 degrees maximum in all 3 planes, and lateral movement of the chip is restricted to 0.5 mm maximum in the pocket (not applicable to vertical clearance.)

Packaging Information

Embossed Carrier Tape Configuration (cont.)

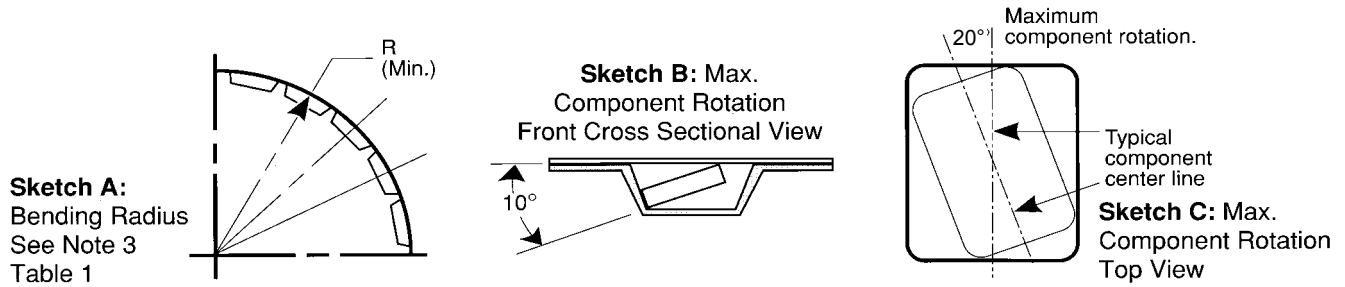

Sketch D: Tape Camber (Top View)

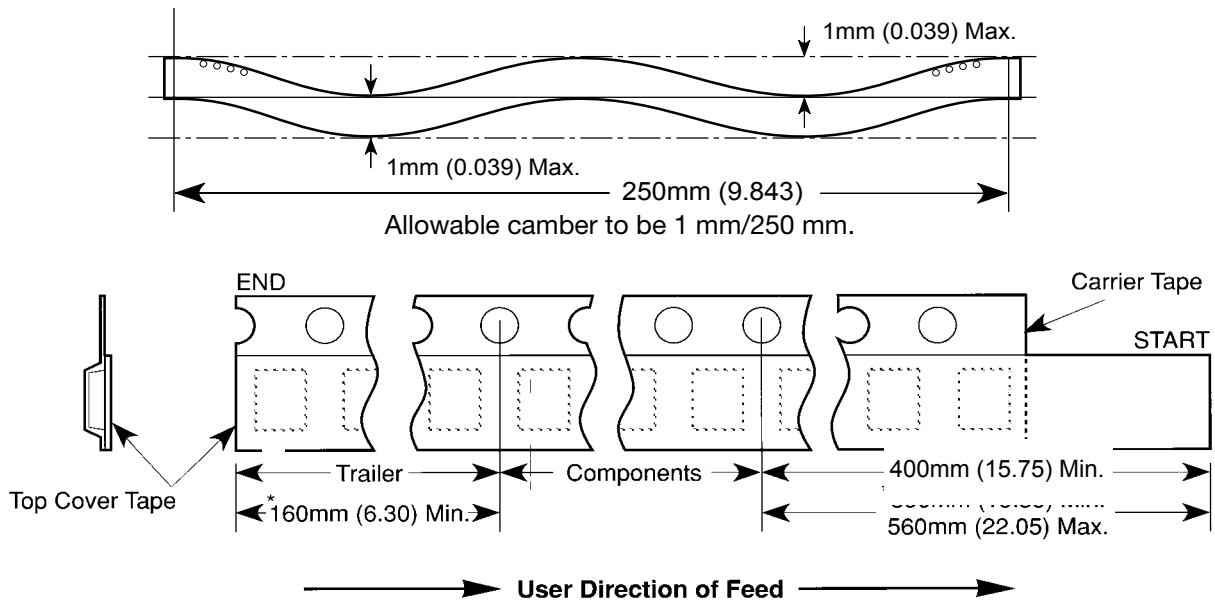

Figure 2: Tape Leader & Trailer Dimensions (Metric Dimensions Will Govern)

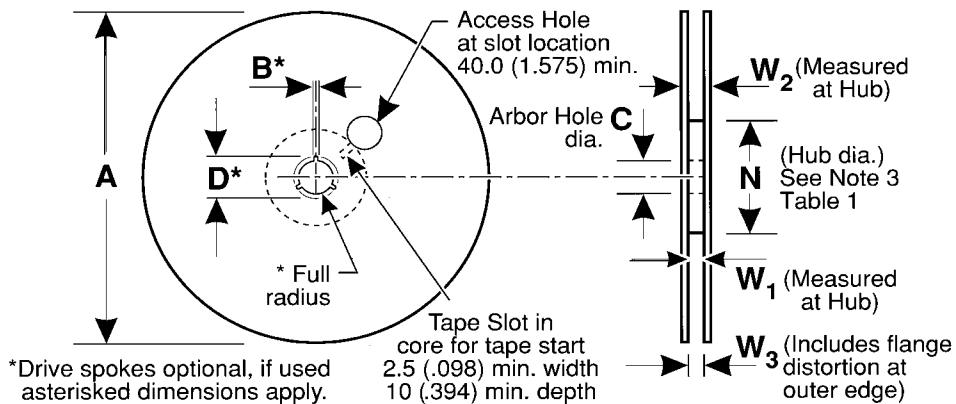

Figure 3: Reel Dimensions (Metric Dimensions will govern)

Table 2 – REEL DIMENSIONS (Metric will govern)

| Tape Size | A Max | B* Min | C | D* Min | N Min | W_1 | W_2 Max | W_3 |
|-----------|-------------------|----------------|--------------------------------|-----------------|----------------------------------|---|-----------------|--|
| 8 mm | 330.0 (12.992) | 1.5 (0.059) | 13.0 ± 0.20 (0.512 ± 0.008) | 20.2 (0.795) | 50.0 (1.969) See Note 3 | 8.4 +1.5, -0.0 (0.331 +0.059, -0.0) | 14.4 (0.567) | 7.9 Min (0.311) 10.9 Max (0.429) |
| 12 mm | 330.0 (12.992) | 1.5 (0.059) | 13.0 ± 0.20 (0.512 ± 0.008) | 20.2 (0.795) | Table 1 | 12.4 +2.0, -0.0 (0.488 +0.078, -0.0) | 18.4 (0.724) | 11.9 Min (0.469) 15.4 Max (0.606) |

Punched Carrier (Paper Tape) Configuration (Ceramic Chips Only):

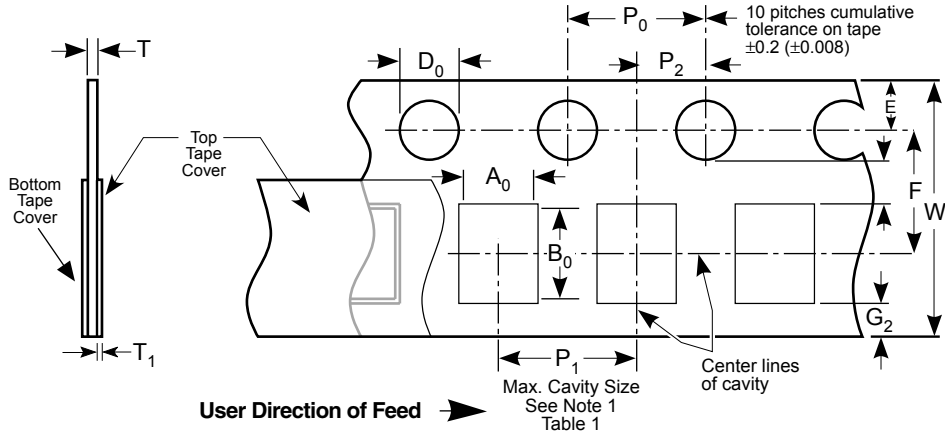

Table 1: 8 & 12mm Punched Tape
(Metric Dimensions Will Govern)

Constant Dimensions - Millimeters (Inches)

| Tape Size | D ₀ | E | P ₀ | P ₂ | T ₁ | G ₁ | G ₂ | R Min. |
|--------------|--|-----------------------------|------------------------------|------------------------------|------------------------|------------------------|------------------------|------------------------------------|
| 8mm and 12mm | 1.5 +0.10, -0.0 (.059 +0.004, -0.0) | 1.75 ±0.10 (.069 ±0.004) | 4.0 ± 0.10 (.157 ± 0.004) | 2.0 ± 0.05 (.079 ± 0.002) | 0.10 (.004) Max. | 0.75 (.030) Min. | 0.75 (.030) Min. | 25 (.984) See Note 2 Table 1 |

Table 1: 8 & 12mm Punched Tape
(Metric Dimensions Will Govern)

Variable Dimensions - Millimeters (Inches)

| Tape Size | P ₁ | F | W | A ₀ B ₀ | T |
|-------------------------|--|-----------------------------|-----------------------------|-------------------------------|--|
| 8mm 1/2 Pitch | 2.0 ± 0.10 (.079 ± .004) See Requirements Section 3.3 (d) | 3.5 ± 0.05 (.138 ± .002) | 8.0 ± 0.3 (.315 ± 0.012) | See Note 1 Table 1 | 1.1mm (.043) Max. for Paper Base Tape and 1.6mm (.063) Max. for Non- Paper Base Compositions. See Note 3. |
| 8mm | 4.0 ± 0.10 (0.157 ± .004) | | | | |
| 12mm | 4.0 ± 0.10 (0.157 ± .004) | 5.5 ± 0.05 (.217 ± .002) | 12.0 ± 0.3 (.472 ± .012) | | |
| 12mm Double Pitch | 8.0 ± 0.10 (0.315 ± .004) | | | | |

Note:

- A₀, B₀ and T determined by the maximum dimensions to the ends of the terminals extending from the body and/or the body dimensions of the component. The clearance between the ends of the terminals or body of the component to the sides and depth of the cavity (A₀, B₀ and T) must be within 0.05mm (.002) minimum and 0.50mm (.020) maximum. The clearance allowed must also prevent rotation of the component within the cavity of not more than 20 degrees (see sketches A and B).
- Tape with components shall pass around radius "R" without damage.
- KEMET nominal thicknesses are: 0402 = 0.6mm and all others 0.95mm minimum.

Sketch A:
Bending Radius
See Note 2
Table 1

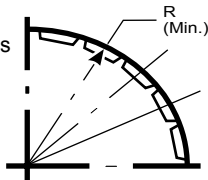

Sketch B:
Max. Component
Rotation - Front
Cross Sectional View

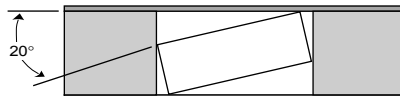

Sketch C:
Component Rotation - Top View

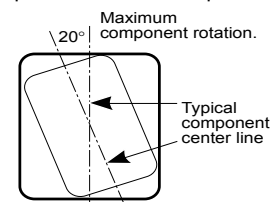

Bulk Cassette Packaging (Ceramic Chips only) (Meets Dimensional Requirements IEC-286-6 and EIAJ 7201)

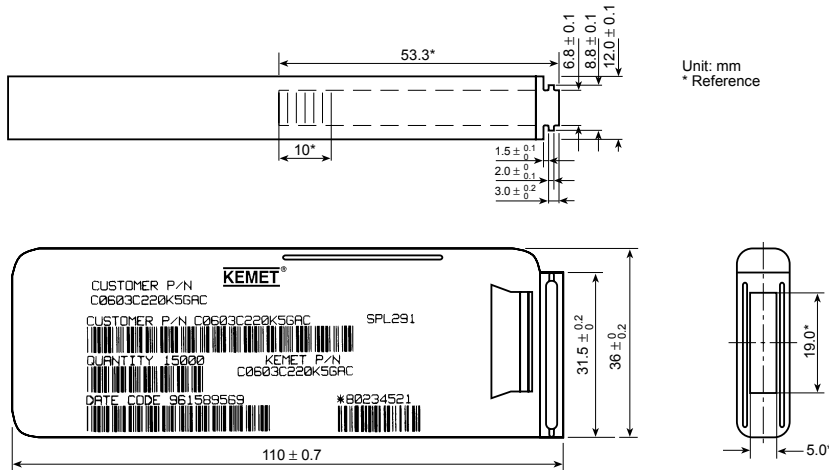

Table 2 – Capacitance Values Available In Bulk Cassette Packaging

| Case Size | Dielectric | Voltage | Min. Cap Value | Max. Cap Value |
|-----------|------------|---------|----------------|----------------|
| 0402 | All | All | All | All |
| 0603 | All | All | All | All |
| 0805 | C0G | All | 109 | 181 |
| | | 100 | 109 | 331 |
| | | 50 | 109 | 102 |
| | X7R | 200 | 221 | 392 |
| | | 100 | 221 | 103 |
| | | 50 | 221 | 273 |
| | | 25 | 221 | 104 |
| | | 16 | 221 | 104 |
| | Y5V | 25 | 104 | 224 |
| 16 | | 104 | 224 | |

Table 1 – Capacitor Dimensions for Bulk Cassette Packaging – Millimeters

| Metric Size Code | EIA Size Code | Length L | Width W | Thickness T | Bandwidth B | Minimum Separation S | Number of Pcs/Cassette |
|------------------|---------------|------------|-------------|-------------|-------------|----------------------|------------------------|
| 1005 | 0402 | 1.0 ± 0.05 | 0.5 ± 0.05 | 0.5 ± .05 | 0.2 to 0.4 | 0.3 | 50,000 |
| 1608 | 0603 | 1.6 ± 0.07 | 0.8 ± 0.07 | 0.8 ± .07 | 0.2 to 0.5 | 0.7 | 15,000 |
| 2012 | 0805 | 2.0 ± 0.10 | 1.25 ± 0.10 | 0.6 ± .10 | 0.5 to 0.75 | 0.75 | 10,000 |

Terminations: KEMET nickel barrier layer with a tin overplate.

CAPACITOR MARKING TABLE (Marking Optional - Not Available for 0402 Size or Y5V Dielectric)

| Alpha Character | Capacitance (pF) For Various Numerical Identifiers | | | | | | |
|-----------------|--|-----|----|-----|------|--------|---------|
| | 9 | 0 | 1 | 2 | 3 | 4 | 5 |
| A | 0.10 | 1.0 | 10 | 100 | 1000 | 10,000 | 100,000 |
| B | 0.11 | 1.1 | 11 | 110 | 1100 | 11,000 | 110,000 |
| C | 0.12 | 1.2 | 12 | 120 | 1200 | 12,000 | 120,000 |
| D | 0.13 | 1.3 | 13 | 130 | 1300 | 13,000 | 130,000 |
| E | 0.15 | 1.5 | 15 | 150 | 1500 | 15,000 | 150,000 |
| F | 0.16 | 1.6 | 16 | 160 | 1600 | 16,000 | 160,000 |
| G | 0.18 | 1.8 | 18 | 180 | 1800 | 18,000 | 180,000 |
| H | 0.20 | 2.0 | 20 | 200 | 2000 | 20,000 | 200,000 |
| J | 0.22 | 2.2 | 22 | 220 | 2200 | 22,000 | 220,000 |
| K | 0.24 | 2.4 | 24 | 240 | 2400 | 24,000 | 240,000 |
| L | 0.27 | 2.7 | 27 | 270 | 2700 | 27,000 | 270,000 |
| M | 0.30 | 3.0 | 30 | 300 | 3000 | 30,000 | 300,000 |
| N | 0.33 | 3.3 | 33 | 330 | 3300 | 33,000 | 330,000 |
| P | 0.36 | 3.6 | 36 | 360 | 3600 | 36,000 | 360,000 |
| Q | 0.39 | 3.9 | 39 | 390 | 3900 | 39,000 | 390,000 |
| R | 0.43 | 4.3 | 43 | 430 | 4300 | 43,000 | 430,000 |
| S | 0.47 | 4.7 | 47 | 470 | 4700 | 47,000 | 470,000 |
| T | 0.51 | 5.1 | 51 | 510 | 5100 | 51,000 | 510,000 |
| U | 0.56 | 5.6 | 56 | 560 | 5600 | 56,000 | 560,000 |
| V | 0.62 | 6.2 | 62 | 620 | 6200 | 62,000 | 620,000 |
| W | 0.68 | 6.8 | 68 | 680 | 6800 | 68,000 | 680,000 |
| X | 0.75 | 7.5 | 75 | 750 | 7500 | 75,000 | 750,000 |
| Y | 0.82 | 8.2 | 82 | 820 | 8200 | 82,000 | 820,000 |
| Z | 0.91 | 9.1 | 91 | 910 | 9100 | 91,000 | 910,000 |
| a | 0.25 | 2.5 | 25 | 250 | 2500 | 25,000 | 250,000 |
| b | 0.35 | 3.5 | 35 | 350 | 3500 | 35,000 | 350,000 |
| d | 0.40 | 4.0 | 40 | 400 | 4000 | 40,000 | 400,000 |
| e | 0.45 | 4.5 | 45 | 450 | 4500 | 45,000 | 450,000 |
| f | 0.50 | 5.0 | 50 | 500 | 5000 | 50,000 | 500,000 |
| m | 0.60 | 6.0 | 60 | 600 | 6000 | 60,000 | 600,000 |
| n | 0.70 | 7.0 | 70 | 700 | 7000 | 70,000 | 700,000 |
| t | 0.80 | 8.0 | 80 | 800 | 8000 | 80,000 | 800,000 |
| y | 0.90 | 9.0 | 90 | 900 | 9000 | 90,000 | 900,000 |

Laser marking is available as an extra-cost option for most KEMET ceramic chips. Such marking is two sided, and includes a \bar{K} to identify KEMET, followed by two characters (per EIA-198 - see table below) to identify the capacitance value. Note that marking is not available for size 0402 nor for any Y5V chip. In addition, the 0603 marking option is limited to the \bar{K} only.



Example shown is 1,000 pF capacitor.