

mm inch

FEATURES

- 40 A rating at 85°C 185°F
- ISO type terminals
- High shock resistance for drop test requirements (2 meters 6.6 feet)
- Low temperature rise — all current carrying material is copper.
- Quick connect and PC board type

SPECIFICATIONS

Contact

(1) Standard type (12V coil voltage)

Arrangement		1 Form A	1 Form C	High contact capacity (1 Form A)
Rating	Nominal switching capacity	40 A 14 V DC	N.O.: 40 A 14 V DC N.C.: 30 A 14 V DC	70 A 14 V DC (at 20°C 68°F) 50 A 14 V DC (at 85°C 185°F)
	Max. switching current (at 85°C 185°F)	40 A 14 V DC	N.O.: 40 A 14 V DC N.C.: 30 A 14 V DC	40 A 14 V DC
Initial contact resistance, max.		15mΩ		
Contact material		Silver alloy		
Expected life	Mechanical (at 120 cpm)	Min. 10 ⁶		
	Electrical (at rated load)	Flux-resistant type: Min. 10 ^{5*1} Sealed type: Min. 5 × 10 ⁴		

(2) Standard type (24V coil voltage)

Arrangement		1 Form A	1 Form C
Rating	Nominal switching capacity	20 A 28V DC	N.O.: 20 A 28 V DC N.C.: 10 A 28 V DC
	Max. switching current (at 85°C 185°F)	20 A 28 V DC	N.O.: 20 A 28 V DC N.C.: 10 A 28 V DC

*1 All other specifications are the same as those of standard type (12V coil voltage)

(3) Heat resistant type (12V, 24V coil voltage)

Type		12V coil voltage		24V coil voltage	
Arrangement		1 Form A	1 Form C	1 Form A	1 Form C
Rating	Nominal switching capacity	35 A 14V DC	N.O.: 35 A 14 V DC N.C.: 30 A 14 V DC	20 A 28 V DC	N.O.: 20 A 28 V DC N.C.: 10 A 28 V DC
	Max. switching current (at 85°C 185°F)	35 A 14 V DC	N.O.: 35 A 14 V DC N.C.: 30 A 14 V DC	20 A 28V DC	N.O.: 20 A 28 V DC N.C.: 10 A 28 V DC

*1 All other specifications are the same as those of standard type (12V coil voltage)

Coil

Arrangement	Coil voltage	Nominal operating power
1 Form A, 1 Form C	12V DC	1.4W
	24V DC	1.8W
High contact capacity	12V DC	1.8W

Characteristics

Max. operating speed (at rated load)	15 cpm	
Initial insulation resistance*2	Min. 20 MΩ (at 500 V DC)	
Initial breakdown voltage*3	Between open contacts	500 Vrms for 1 min.
	Between contacts and coil	500 Vrms for 1 min.
Operate time*4 (at nominal voltage)	Max. 15 ms	
Release time (without diode)*4 (at nominal voltage)	Max. 15 ms	
Shock resistance	Functional*5	Min. 200 m/s ² {20 G}
	Destructive*6	Min. 1,000 m/s ² {100 G}
Vibration resistance	Functional*7	10 to 500Hz, Min. 44.1m/s ² {4.5G}
	Functional*8	10 to 2,000Hz, Min. 44.1m/s ² {4.5G}
Conditions for operation, transport and storage*9 (Not freezing and condensing at low temperature)	Ambient temp.	-40°C to +85°C -40°F to +185°F (Heat resistant type: -40°C to +125°C -40°F to +257°F)
	Humidity	5 to 85% R.H.
Unit weight	Approx. 33 g 1.16 oz	

Remarks

- * Specifications will vary with foreign standards certification ratings.
- *1 All other specifications are the same as those of standard type (12V coil voltage)
- *2 Measurement at same location as "Initial breakdown voltage" section
- *3 Detection current: 10 mA
- *4 Wave is standard shock voltage of $\pm 1.2 \times 50\mu\text{s}$ according to JEC-212-1981
- *5 Excluding contact bounce time

- *6 Half-wave pulse of sine wave: 11ms; detection time: 10μs
- *7 Half-wave pulse of sine wave: 6ms
- *8 Detection time: 10μs
- *9 Refer to 5. Conditions for operation, transport and storage mentioned in AMBIENT ENVIRONMENT (Page 61)

TYPICAL APPLICATIONS

- Automotive system
- ABS, Head Lamp, Air conditioner
- Tracter, Combine

ORDERING INFORMATION

CB	1	F	—	T	—	R	—	M	—	12 V
Contact arrangement	Protective construction	Heat resistant of types		Type classification		Mounting classification		Coil voltage (DC)		
1a: 1 Form A 1: 1 Form C 1aH: High contact capacity*1 (1 Form A)	Nil: Sealed type F: Flux-resistant type	Nil: Standard type T: Heat resistant type*2		Nil: Standard type D: with diode inside R: with resistor inside		Nil: Quick connect type P: PC board type M: Bracket type		12, 24 V		

Note: Bulk package: 50 pcs.; Case: 200 pcs.

- *1 High contact capacity type is available only for "Quick connect" and 12 V.
(See "1. Standard type in TYPES" Page 380)
- *2 Heat resistant type with high contact capacity is not available.
(See "2. Heat resistant type in TYPES" Page 381)

TYPES

1. Standard type

Contact arrangement	Mounting classification	Coil voltage, V DC	Part No.	
			Sealed type	Flux-resistant type
1 Form A	PC board type	12V	CB1a-P-12V	CB1aF-P-12V
		24V	CB1a-P-24V	CB1aF-P-24V
	Quick connect type	12V	CB1a-12V	CB1aF-12V
		24V	CB1a-24V	CB1aF-24V
	Bracket type	12V	CB1a-M-12V	CB1aF-M-12V
		24V	CB1a-M-24V	CB1aF-M-24V
1 Form C	PC board type	12V	CB1-P-12V	CB1F-P-12V
		24V	CB1-P-24V	CB1F-P-24V
	Quick connect type	12V	CB1-12V	CB1F-12V
		24V	CB1-24V	CB1F-24V
	Bracket type	12V	CB1-M-12V	CB1F-M-12V
		24V	CB1-M-24V	CB1F-M-24V
High contact capacity (1 Form A)	Quick connect type	12V	CB1aH-12V	CB1aHF-12V

2. Heat resistant type

Contact arrangement	Mounting classification	Coil voltage, V DC	Part No.	
			Sealed type	Flux-resistant type
1 Form A	PC board type	12V	CB1a-T-P-12V	CB1aF-T-P-12V
		24V	CB1a-T-P-24V	CB1aF-T-P-24V
	Quick connect type	12V	CB1a-T-12V	CB1aF-T-12V
		24V	CB1a-T-24V	CB1aF-T-24V
	Bracket type	12V	CB1a-T-M-12V	CB1aF-T-M-12V
		24V	CB1a-T-M-24V	CB1aF-T-M-24V
1 Form C	PC board type	12V	CB1-T-P-12V	CB1F-T-P-12V
		24V	CB1-T-P-24V	CB1F-T-P-24V
	Quick connect type	12V	CB1-T-12V	CB1F-T-12V
		24V	CB1-T-24V	CB1F-T-24V
	Bracket type	12V	CB1-T-M-12V	CB1F-T-M-12V
		24V	CB1-T-M-24V	CB1F-T-M-24V

COIL DATA (at 20°C 68°F)

Contact arrangement	Nominal voltage, V DC	Pick-up voltage, V DC (max.)	Drop-out voltage, V DC (mim.)	Nominal current, mA (±10%)	Coil resistance, Ω (±10%)	Nominal operating power, W	Usable voltage range, V DC
1 Form A	12	3 to 7	1.2 to 4.2	117	103	1.4	10 to 16
1 Form C	24	6 to 14	2.4 to 8.4	75	320	1.8	20 to 32
High contact capacity (1 Form A)	12	3 to 7	1.2 to 4.2	150	80	1.8	10 to 16

DIMENSIONS

mm inch

1. PC board type

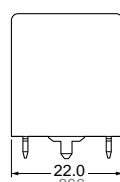
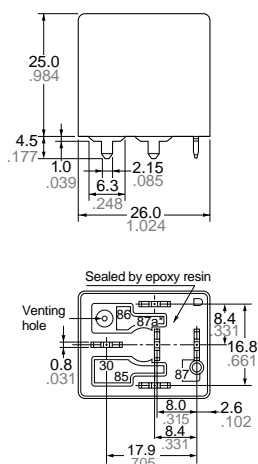

Schematic (Bottom view)

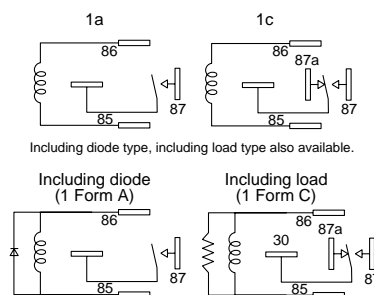

Dimension:
 Max. 1mm .039 inch:
 1 to 3mm .039 to .118 inch:
 Min. 3mm .118 inch:

General tolerance
 ±0.1 ±.004
 ±0.2 ±.008
 ±0.3 ±.012

2. Quick connect type

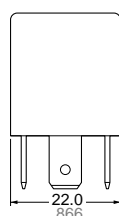
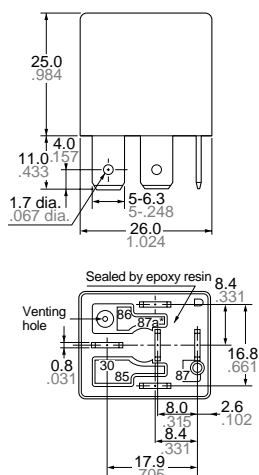

Schematic (Bottom view)

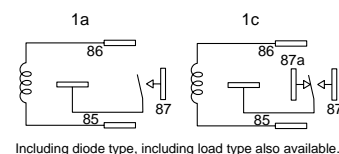

Dimension:
 Max. 1mm .039 inch:
 1 to 3mm .039 to .118 inch:
 Min. 3mm .118 inch:

General tolerance
 ±0.1 ±.004
 ±0.2 ±.008
 ±0.3 ±.012

3. Bracket type

mm inch

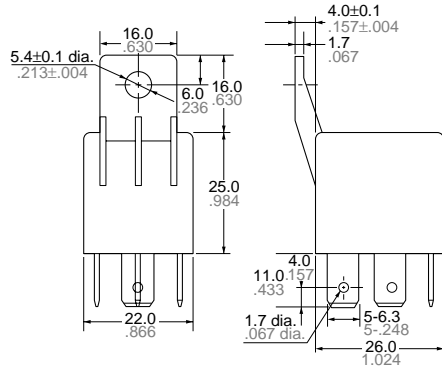

Schematic (Bottom view)

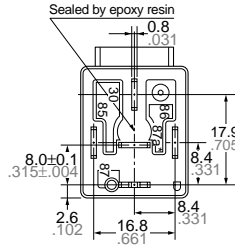
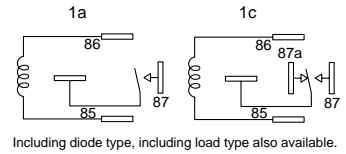

Dimension:	General tolerance
Max. 1mm .039 inch:	±0.1 ±.004
1 to 3mm .039 to .118 inch:	±0.2 ±.008
Min. 3mm .118 inch:	±0.3 ±.012

4. High contact capacity type

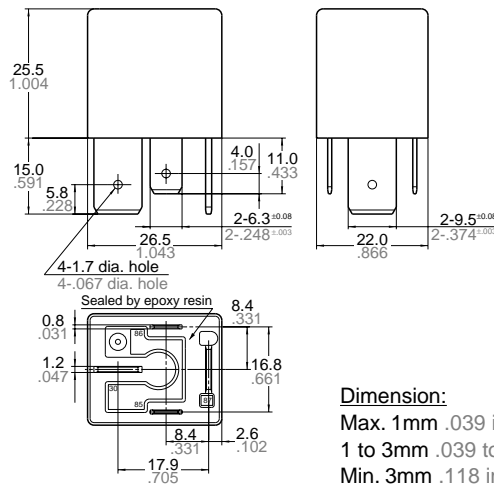

Schematic (Bottom view)

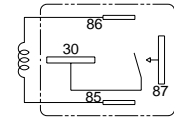

Dimension:	General tolerance
Max. 1mm .039 inch:	±0.1 ±.004
1 to 3mm .039 to .118 inch:	±0.2 ±.008
Min. 3mm .118 inch:	±0.3 ±.012

REFERENCE DATA

1. Coil temperature rise

Tested sample: CB1aF-P-12V, 3pcs.
Ambient temperature: 85°C 185°F
Contact carrying current: 40A

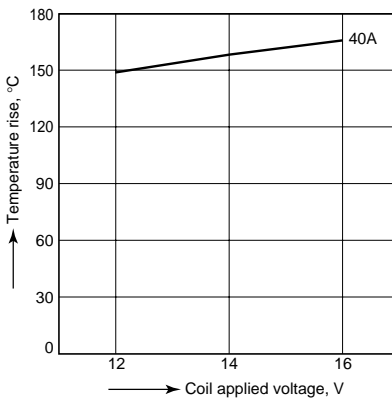

2. Electrical life test (Motor load)

Tested sample: CB1a-12V, 3pcs.
Load: 18A steady, Inrush 82A
Operating frequency: ON 2s, OFF 6s

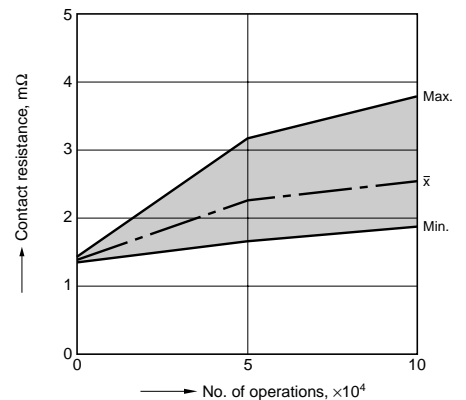
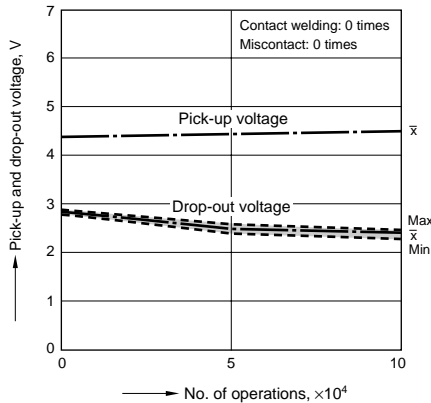

For Cautions for use, see Relay Technical Information (Page 48 to 76).