



# MULTILAYER CERAMIC CHIP CAPACITORS



## CGA Series Automotive Grade Capacitors

Type: CGA2 [EIA CC0402]  
CGA3 [EIA CC0603]  
CGA4 [EIA CC0805]  
CGA5 [EIA CC1206]  
CGA6 [EIA CC1210]

Issue date: April 2011

TDK MLCC  
US Catalog

Version B11

## REMINDERS

Please read before using this product

### SAFETY REMINDERS



### REMINDERS

1. If you intend to use a product listed in this catalog for a purpose that may cause loss of life or other damage, you must contact our company's sales window.
2. We may modify products or discontinue production of a product listed in this catalog without prior notification.
3. We provide "Delivery Specification" that explain precautions for the specifications and safety of each product listed in this catalog. We strongly recommend that you exchange these delivery specifications with customers that use one of these products.
4. If you plan to export a product listed in this catalog, keep in mind that it may be a restricted item according to the "Foreign Exchange and Foreign Trade Control Law". In such cases, it is necessary to acquire export permission in harmony with this law.
5. Any reproduction or transferring of the contents of this catalog is prohibited without prior permission from our company.
6. We are not responsible for problems that occur related to the intellectual property rights or other rights of our company or a third party when you use a product listed in this catalog. We do not grant license of these rights.
7. This catalog only applies to products purchased through our company or one of our company's official agencies. This catalog does not apply to products that are purchased through other third parties.

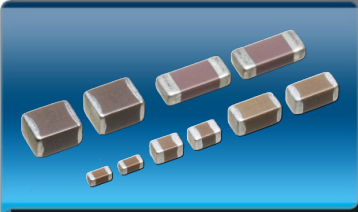

# CGA Series

## Automotive Grade Capacitors

Type: CGA2 (C1005), CGA3 (C1608),  
CGA4 (C2012), CGA5 (C3216), CGA6 (C3225)

### Features



- The CGA series consists of products that can be used for the power train, safety equipment, etc. of a vehicle
- Qualified to AEC Q200 test standard
- Parts are manufactured using tested and stable manufacturing processes and are subjected to increased inspections to guarantee a higher level of reliability
- A monolithic structure ensures superior mechanical strength and reliability
- Available in X8R temperature characteristic for up to 150°C operating temperature
- High capacitance has been achieved through precision technologies that enable the use of multiple thinner ceramic dielectric layers
- High-accuracy automatic mounting is facilitated through the maintenance of very precise dimensional tolerances
- Low stray capacitance ensures high conformity with nominal values, thereby simplifying the circuit design process

### Applications



- Automotive applications
- High reliability requirement applications
- Harsh environment requirement applications
- Smart meter
- Base stations
- Noise bypass in automotive

### Shape & Dimensions

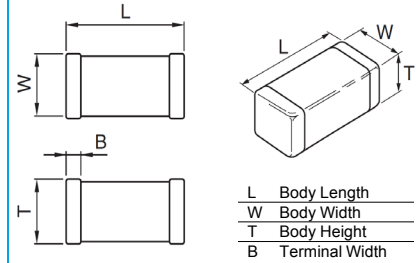

Dimensions in mm



### Part Number Construction

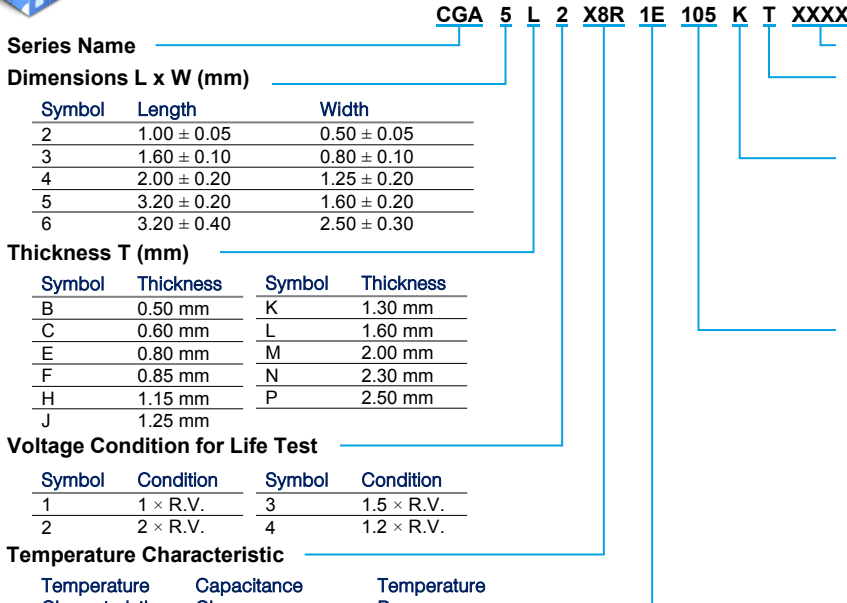

### Internal Codes

#### Packaging Style

Packaging Code	Style
T	Tape & Reel

#### Capacitance Tolerance

Tolerance Code	Tolerance
C	± 0.25 pF
D	± 0.50 pF
J	± 5%
K	± 10%
M	± 20%

#### Nominal Capacitance (pF)

The capacitance is expressed in three digit codes and in units of pico Farads (pF). The first and second digits identify the first and second significant figures of the capacitance. The third digit identifies the multiplier. R designates a decimal point.

Capacitance Code	Capacitance
0R5	0.5pF
010	1pF
102	1,000pF (1nF)
105	1,000,000pF (1µF)

#### Rated Voltage (DC)

Voltage Code	Voltage (DC)	Voltage Code	Voltage (DC)
0J	6.3V	1H	50V
1A	10V	2A	100V
1C	16V	2E	250V
1E	25V	2W	450V
1V	35V	2J	630V



**Capacitance Range Chart**

**CGA2 [EIA CC0402]**

**Capacitance Range Chart**

Temperature Characteristics: COG (0±30 ppm/°C)

Rated Voltage: 50V (1H)

Capacitance (pF)	Cap Code	Tolerance	COG
			1H (50V)
1	010	C: ± 0.25pF	█
1.5	1R5		█
2	020		█
2.2	2R2		█
3	030		█
3.3	3R3	D: ± 0.50pF	█
4	040		█
4.7	4R7		█
5	050		█
6	060		█
6.8	6R8	J: ± 5%	█
7	070		█
8	080		█
9	090		█
10	100		█
12	120		█
15	150		█
18	180		█
22	220		█
27	270		█
33	330	█	
39	390	█	
47	470	█	
56	560	█	
68	680	█	
82	820	█	
100	101	█	
120	121	█	
150	151	█	
180	181	█	
220	221	█	
270	271	█	
330	331	█	
390	391	█	
470	471	█	
560	561	█	
680	681	█	
820	821	█	
1,000	102	█	

**Standard Thickness**

0.50 mm



## Capacitance Range Chart

## CGA2 [EIA CC0402]

### Capacitance Range Chart

Temperature Characteristics: X7R ( $\pm 15\%$ ), X7S ( $\pm 22\%$ ), X8R ( $\pm 15\%$ )

Rated Voltage: 100V (2A), 50V (1H), 35V (1V), 25V (1E), 16V (1C), 10V (1A)

Capacitance (pF)	Cap Code	Tolerance	X7R					X7S	X8R	
			1H (50V)	1V (35V)	1E (25V)	1C (16V)	1A (10V)	2A (100V)	1H (50V)	1E (25V)
150	151	K: $\pm 10\%$								
220	221									
330	331									
470	471									
680	681									
1,000	102									
1,500	152									
2,200	222									
3,300	332									
4,700	472									
6,800	682									
10,000	103									
15,000	153									
22,000	223									
33,000	333									
47,000	473									
68,000	683									
100,000	104									
220,000	224									

#### Standard Thickness

0.50 mm



## Capacitance Range Table

## CGA2 [EIA CC0402]

### Class 1 (Temperature Compensating)

Temperature Characteristics: COG (-55 to 125°C, 0±30 ppm/°C)

TDK Part Number (Ordering Code)	Temperature Characteristics	Rated Voltage	Capacitance (pF)	Capacitance Tolerance	Thickness (mm)
CGA2B2C0G1H010C	COG	50V	1.0	± 0.25pF	0.50 ± 0.05
CGA2B2C0G1H1R5C	COG	50V	1.5	± 0.25pF	0.50 ± 0.05
CGA2B2C0G1H020C	COG	50V	2.0	± 0.25pF	0.50 ± 0.05
CGA2B2C0G1H2R2C	COG	50V	2.2	± 0.25pF	0.50 ± 0.05
CGA2B2C0G1H030C	COG	50V	3.0	± 0.25pF	0.50 ± 0.05
CGA2B2C0G1H3R3C	COG	50V	3.3	± 0.25pF	0.50 ± 0.05
CGA2B2C0G1H040C	COG	50V	4.0	± 0.25pF	0.50 ± 0.05
CGA2B2C0G1H4R7C	COG	50V	4.7	± 0.25pF	0.50 ± 0.05
CGA2B2C0G1H050C	COG	50V	5.0	± 0.25pF	0.50 ± 0.05
CGA2B2C0G1H060D	COG	50V	6.0	± 0.50pF	0.50 ± 0.05
CGA2B2C0G1H6R8D	COG	50V	6.8	± 0.50pF	0.50 ± 0.05
CGA2B2C0G1H070D	COG	50V	7.0	± 0.50pF	0.50 ± 0.05
CGA2B2C0G1H080D	COG	50V	8.0	± 0.50pF	0.50 ± 0.05
CGA2B2C0G1H090D	COG	50V	9.0	± 0.50pF	0.50 ± 0.05
CGA2B2C0G1H100D	COG	50V	10	± 0.50pF	0.50 ± 0.05
CGA2B2C0G1H120J	COG	50V	12	± 5%	0.50 ± 0.05
CGA2B2C0G1H150J	COG	50V	15	± 5%	0.50 ± 0.05
CGA2B2C0G1H180J	COG	50V	18	± 5%	0.50 ± 0.05
CGA2B2C0G1H220J	COG	50V	22	± 5%	0.50 ± 0.05
CGA2B2C0G1H270J	COG	50V	27	± 5%	0.50 ± 0.05
CGA2B2C0G1H330J	COG	50V	33	± 5%	0.50 ± 0.05
CGA2B2C0G1H390J	COG	50V	39	± 5%	0.50 ± 0.05
CGA2B2C0G1H470J	COG	50V	47	± 5%	0.50 ± 0.05
CGA2B2C0G1H560J	COG	50V	56	± 5%	0.50 ± 0.05
CGA2B2C0G1H680J	COG	50V	68	± 5%	0.50 ± 0.05
CGA2B2C0G1H820J	COG	50V	82	± 5%	0.50 ± 0.05
CGA2B2C0G1H101J	COG	50V	100	± 5%	0.50 ± 0.05
CGA2B2C0G1H121J	COG	50V	120	± 5%	0.50 ± 0.05
CGA2B2C0G1H151J	COG	50V	150	± 5%	0.50 ± 0.05
CGA2B2C0G1H181J	COG	50V	180	± 5%	0.50 ± 0.05
CGA2B2C0G1H221J	COG	50V	220	± 5%	0.50 ± 0.05
CGA2B2C0G1H271J	COG	50V	270	± 5%	0.50 ± 0.05
CGA2B2C0G1H331J	COG	50V	330	± 5%	0.50 ± 0.05
CGA2B2C0G1H391J	COG	50V	390	± 5%	0.50 ± 0.05
CGA2B2C0G1H471J	COG	50V	470	± 5%	0.50 ± 0.05
CGA2B2C0G1H561J	COG	50V	560	± 5%	0.50 ± 0.05
CGA2B2C0G1H681J	COG	50V	680	± 5%	0.50 ± 0.05
CGA2B2C0G1H821J	COG	50V	820	± 5%	0.50 ± 0.05
CGA2B2C0G1H102J	COG	50V	1,000	± 5%	0.50 ± 0.05



## Capacitance Range Table

## CGA2 [EIA CC0402]

### Class 2 (Temperature Stable)

Temperature Characteristics: X7R (-55 to +125°C, ±15%), X6S (-55 to +105°C, ±22%), X5R (-55 to +85°C, ±15%), Y5V (-30 to +85°C, +22/-82%)

TDK Part Number (Ordering Code)	Temperature Characteristics	Rated Voltage	Capacitance (pF)	Capacitance Tolerance	Thickness (mm)
CGA2B2X7R1H221K	X7R	50V	220	± 10%	0.50 ± 0.05
CGA2B2X7R1H331K	X7R	50V	330	± 10%	0.50 ± 0.05
CGA2B2X7R1H471K	X7R	50V	470	± 10%	0.50 ± 0.05
CGA2B2X7R1H681K	X7R	50V	680	± 10%	0.50 ± 0.05
CGA2B2X7R1H102K	X7R	50V	1,000	± 10%	0.50 ± 0.05
CGA2B2X7R1H152K	X7R	50V	1,500	± 10%	0.50 ± 0.05
CGA2B2X7R1H222K	X7R	50V	2,200	± 10%	0.50 ± 0.05
CGA2B2X7R1H332K	X7R	50V	3,300	± 10%	0.50 ± 0.05
CGA2B2X7R1H472K	X7R	50V	4,700	± 10%	0.50 ± 0.05
CGA2B2X7R1H682K	X7R	50V	6,800	± 10%	0.50 ± 0.05
CGA2B3X7R1H103K	X7R	50V	10,000	± 10%	0.50 ± 0.05
CGA2B3X7R1H153K	X7R	50V	15,000	± 10%	0.50 ± 0.05
CGA2B3X7R1H223K	X7R	50V	22,000	± 10%	0.50 ± 0.05
CGA2B3X7R1H333K	X7R	50V	33,000	± 10%	0.50 ± 0.05
CGA2B3X7R1H473K	X7R	50V	47,000	± 10%	0.50 ± 0.05
CGA2B3X7R1H683K	X7R	50V	68,000	± 10%	0.50 ± 0.05
CGA2B3X7R1H104K	X7R	50V	100,000	± 10%	0.50 ± 0.05
CGA2B3X7R1V103K	X7R	35V	10,000	± 10%	0.50 ± 0.05
CGA2B3X7R1V104K	X7R	35V	100,000	± 10%	0.50 ± 0.05
CGA2B2X7R1E103K	X7R	25V	10,000	± 10%	0.50 ± 0.05
CGA2B2X7R1E223K	X7R	25V	22,000	± 10%	0.50 ± 0.05
CGA2B1X7R1E473K	X7R	25V	47,000	± 10%	0.50 ± 0.05
CGA2B3X7R1E104K	X7R	25V	100,000	± 10%	0.50 ± 0.05
CGA2B2X7R1C473K	X7R	16V	47,000	± 10%	0.50 ± 0.05
CGA2B1X7R1C683K	X7R	16V	68,000	± 10%	0.50 ± 0.05
CGA2B1X7R1C104K	X7R	16V	100,000	± 10%	0.50 ± 0.05
CGA2B1X7R1A224K	X7R	10V	220,000	± 10%	0.50 ± 0.05
CGA2B3X7S2A102K	X7S	100V	1,000	± 10%	0.50 ± 0.05
CGA2B3X7S2A152K	X7S	100V	1,500	± 10%	0.50 ± 0.05
CGA2B3X7S2A222K	X7S	100V	2,200	± 10%	0.50 ± 0.05
CGA2B3X7S2A332K	X7S	100V	3,300	± 10%	0.50 ± 0.05
CGA2B3X7S2A472K	X7S	100V	4,700	± 10%	0.50 ± 0.05
CGA2B3X7S2A682K	X7S	100V	6,800	± 10%	0.50 ± 0.05
CGA2B3X7S2A103K	X7S	100V	10,000	± 10%	0.50 ± 0.05
CGA2B2X8R1H151K	X8R	50V	150	± 10%	0.50 ± 0.05
CGA2B2X8R1H221K	X8R	50V	220	± 10%	0.50 ± 0.05
CGA2B2X8R1H331K	X8R	50V	330	± 10%	0.50 ± 0.05
CGA2B2X8R1H471K	X8R	50V	470	± 10%	0.50 ± 0.05
CGA2B2X8R1H681K	X8R	50V	680	± 10%	0.50 ± 0.05
CGA2B2X8R1H102K	X8R	50V	1,000	± 10%	0.50 ± 0.05
CGA2B2X8R1H152K	X8R	50V	1,500	± 10%	0.50 ± 0.05
CGA2B2X8R1H222K	X8R	50V	2,200	± 10%	0.50 ± 0.05
CGA2B2X8R1H332K	X8R	50V	3,300	± 10%	0.50 ± 0.05
CGA2B2X8R1H472K	X8R	50V	4,700	± 10%	0.50 ± 0.05



## Capacitance Range Table

## CGA2 [EIA CC0402]

### Class 2 (Temperature Stable)

Temperature Characteristics: X7R (-55 to +125°C, ±15%), X6S (-55 to +105°C, ±22%), X5R (-55 to +85°C, ±15%), Y5V(-30 to +85°C, +22/-82%)

TDK Part Number (Ordering Code)	Temperature Characteristics	Rated Voltage	Capacitance (pF)	Capacitance Tolerance	Thickness (mm)
CGA2B2X8R1E682K	X8R	25V	6,800	± 10%	0.50 ± 0.05
CGA2B2X8R1E103K	X8R	25V	10,000	± 10%	0.50 ± 0.05





## Capacitance Range Chart

## CGA3 [EIA CC0603]

### Capacitance Range Chart

Temperature Characteristics: COG (0±30 ppm/°C)

Rated Voltage: 250V (2E), 100V (2A), 50V (1H)

Capacitance (pF)	Cap Code	Tolerance	COG		
			2E (250V)	2A (100V)	1H (50V)
1	010	C: ± 0.25pF			
1.5	1R5				
2	020				
2.2	2R2				
3	030				
3.3	3R3				
4	040				
4.7	4R7				
5	050				
6	060	D: ± 0.50pF			
6.8	6R8				
7	070				
8	080				
9	090				
10	100	J: ± 5%			
12	120				
15	150				
18	180				
22	220				
27	270				
33	330				
39	390				
47	470				
56	560				
68	680				
82	820				
100	101				
120	121				
150	151				
180	181				
220	221				
270	271				
330	331				
390	391				
470	471				
560	561				
680	681				
820	821				
1,000	102				
1,200	122				
1,500	152				
1,800	182				
2,200	222				
2,700	272				
3,300	332				
3,900	392				
4,700	472				
5,600	562				
6,800	682				
8,200	822				
10,000	103				

Standard Thickness

 0.80 mm



## Capacitance Range Chart

## CGA3 [EIA CC0603]

### Capacitance Range Chart

Temperature Characteristics: X7R ( $\pm 15\%$ ), X7S ( $\pm 22\%$ ), X8R ( $\pm 15\%$ ), X5R ( $\pm 15\%$ )  
 Rated Voltage: 100V (2A), 50V (1H), 35V (1V), 25V (1E), 16V (1C), 6.3V (0J)

Capacitance (pF)	Cap Code	Tolerance	X7R						X7S
			2A (100V)	1H (50V)	1V (35V)	1E (25V)	1C (16V)	0J (6.3V)	2A (100V)
220	221	K: $\pm 10\%$							
330	331								
470	471								
680	681								
1,000	102								
1,500	152								
2,200	222								
3,300	332								
4,700	472								
6,800	682								
10,000	103								
15,000	153								
22,000	223								
33,000	333								
47,000	473								
68,000	683								
100,000	104								
150,000	154								
220,000	224								
330,000	334								
470,000	474								
680,000	684								
1,000,000	105								
2,200,000	225								

Capacitance (pF)	Cap Code	Tolerance	X8R			X5R	
			2A (100V)	1H (50V)	1E (25V)	1C (16V)	0J (6.3V)
1,000	102	K: $\pm 10\%$					
1,500	152						
2,200	222						
3,300	332						
4,700	472						
6,800	682						
10,000	103						
15,000	153						
22,000	223						
33,000	333						
47,000	473						
68,000	683						
100,000	104						
2,200,000	225						
4,700,000	475						

Standard Thickness  
 0.80 mm



## Capacitance Range Table

## CGA3 [EIA CC0603]

### Class 1 (Temperature Compensating)

Temperature Characteristics: COG (-55 to 125°C, 0±30 ppm/°C)

TDK Part Number (Ordering Code)	Temperature Characteristics	Rated Voltage	Capacitance (pF)	Capacitance Tolerance	Thickness (mm)
CGA3E2C0G1H010C	COG	50V	1.0	± 0.25pF	0.80 ± 0.10
CGA3E2C0G1H1R5C	COG	50V	1.5	± 0.25pF	0.80 ± 0.10
CGA3E2C0G1H020C	COG	50V	2.0	± 0.25pF	0.80 ± 0.10
CGA3E2C0G1H2R2C	COG	50V	2.2	± 0.25pF	0.80 ± 0.10
CGA3E2C0G1H030C	COG	50V	3.0	± 0.25pF	0.80 ± 0.10
CGA3E2C0G1H3R3C	COG	50V	3.3	± 0.25pF	0.80 ± 0.10
CGA3E2C0G1H040C	COG	50V	4.0	± 0.25pF	0.80 ± 0.10
CGA3E2C0G1H4R7C	COG	50V	4.7	± 0.25pF	0.80 ± 0.10
CGA3E2C0G1H050C	COG	50V	5.0	± 0.25pF	0.80 ± 0.10
CGA3E2C0G1H060D	COG	50V	6.0	± 0.50pF	0.80 ± 0.10
CGA3E2C0G1H6R8D	COG	50V	6.8	± 0.50pF	0.80 ± 0.10
CGA3E2C0G1H070D	COG	50V	7.0	± 0.50pF	0.80 ± 0.10
CGA3E2C0G1H080D	COG	50V	8.0	± 0.50pF	0.80 ± 0.10
CGA3E2C0G1H090D	COG	50V	9.0	± 0.50pF	0.80 ± 0.10
CGA3E2C0G1H100D	COG	50V	10	± 0.50pF	0.80 ± 0.10
CGA3E2C0G1H120J	COG	50V	12	± 5%	0.80 ± 0.10
CGA3E2C0G1H150J	COG	50V	15	± 5%	0.80 ± 0.10
CGA3E2C0G1H180J	COG	50V	18	± 5%	0.80 ± 0.10
CGA3E2C0G1H220J	COG	50V	22	± 5%	0.80 ± 0.10
CGA3E2C0G1H270J	COG	50V	27	± 5%	0.80 ± 0.10
CGA3E2C0G1H330J	COG	50V	33	± 5%	0.80 ± 0.10
CGA3E2C0G1H390J	COG	50V	39	± 5%	0.80 ± 0.10
CGA3E2C0G1H470J	COG	50V	47	± 5%	0.80 ± 0.10
CGA3E2C0G1H560J	COG	50V	56	± 5%	0.80 ± 0.10
CGA3E2C0G1H680J	COG	50V	68	± 5%	0.80 ± 0.10
CGA3E2C0G1H820J	COG	50V	82	± 5%	0.80 ± 0.10
CGA3E2C0G1H101J	COG	50V	100	± 5%	0.80 ± 0.10
CGA3E2C0G1H121J	COG	50V	120	± 5%	0.80 ± 0.10
CGA3E2C0G1H151J	COG	50V	150	± 5%	0.80 ± 0.10
CGA3E2C0G1H181J	COG	50V	180	± 5%	0.80 ± 0.10
CGA3E2C0G1H221J	COG	50V	220	± 5%	0.80 ± 0.10
CGA3E2C0G1H271J	COG	50V	270	± 5%	0.80 ± 0.10
CGA3E2C0G1H331J	COG	50V	330	± 5%	0.80 ± 0.10
CGA3E2C0G1H391J	COG	50V	390	± 5%	0.80 ± 0.10
CGA3E2C0G1H471J	COG	50V	470	± 5%	0.80 ± 0.10
CGA3E2C0G1H561J	COG	50V	560	± 5%	0.80 ± 0.10
CGA3E2C0G1H681J	COG	50V	680	± 5%	0.80 ± 0.10
CGA3E2C0G1H821J	COG	50V	820	± 5%	0.80 ± 0.10
CGA3E2C0G1H102J	COG	50V	1,000	± 5%	0.80 ± 0.10
CGA3E2C0G1H122J	COG	50V	1,200	± 5%	0.80 ± 0.10
CGA3E2C0G1H152J	COG	50V	1,500	± 5%	0.80 ± 0.10
CGA3E2C0G1H182J	COG	50V	1,800	± 5%	0.80 ± 0.10
CGA3E2C0G1H222J	COG	50V	2,200	± 5%	0.80 ± 0.10
CGA3E2C0G1H272J	COG	50V	2,700	± 5%	0.80 ± 0.10



## Capacitance Range Table

## CGA3 [EIA CC0603]

### Class 1 (Temperature Compensating)

Temperature Characteristics: COG (-55 to 125°C, 0±30 ppm/°C)

TDK Part Number (Ordering Code)	Temperature Characteristics	Rated Voltage	Capacitance (pF)	Capacitance Tolerance	Thickness (mm)
CGA3E2C0G1H332J	COG	50V	3,300	± 5%	0.80 ± 0.10
CGA3E2C0G1H392J	COG	50V	3,900	± 5%	0.80 ± 0.10
CGA3E2C0G1H472J	COG	50V	4,700	± 5%	0.80 ± 0.10
CGA3E2C0G1H562J	COG	50V	5,600	± 5%	0.80 ± 0.10
CGA3E2C0G1H682J	COG	50V	6,800	± 5%	0.80 ± 0.10
CGA3E2C0G1H822J	COG	50V	8,200	± 5%	0.80 ± 0.10
CGA3E2C0G1H103J	COG	50V	10,000	± 5%	0.80 ± 0.10
CGA3E2C0G2A101J	COG	100V	100	± 5%	0.80 ± 0.10
CGA3E2C0G2A121J	COG	100V	120	± 5%	0.80 ± 0.10
CGA3E2C0G2A151J	COG	100V	150	± 5%	0.80 ± 0.10
CGA3E2C0G2A181J	COG	100V	180	± 5%	0.80 ± 0.10
CGA3E2C0G2A221J	COG	100V	220	± 5%	0.80 ± 0.10
CGA3E2C0G2A271J	COG	100V	270	± 5%	0.80 ± 0.10
CGA3E2C0G2A331J	COG	100V	330	± 5%	0.80 ± 0.10
CGA3E2C0G2A391J	COG	100V	390	± 5%	0.80 ± 0.10
CGA3E2C0G2A471J	COG	100V	470	± 5%	0.80 ± 0.10
CGA3E2C0G2A561J	COG	100V	560	± 5%	0.80 ± 0.10
CGA3E2C0G2A681J	COG	100V	680	± 5%	0.80 ± 0.10
CGA3E2C0G2A821J	COG	100V	820	± 5%	0.80 ± 0.10
CGA3E2C0G2A102J	COG	100V	1,000	± 5%	0.80 ± 0.10
CGA3E2C0G2A122J	COG	100V	1,200	± 5%	0.80 ± 0.10
CGA3E3C0G2E101J	COG	250V	100	± 5%	0.80 ± 0.10
CGA3E3C0G2E121J	COG	250V	120	± 5%	0.80 ± 0.10
CGA3E3C0G2E151J	COG	250V	150	± 5%	0.80 ± 0.10
CGA3E3C0G2E181J	COG	250V	180	± 5%	0.80 ± 0.10
CGA3E3C0G2E221J	COG	250V	220	± 5%	0.80 ± 0.10
CGA3E3C0G2E271J	COG	250V	270	± 5%	0.80 ± 0.10
CGA3E3C0G2E331J	COG	250V	330	± 5%	0.80 ± 0.10
CGA3E3C0G2E391J	COG	250V	390	± 5%	0.80 ± 0.10
CGA3E3C0G2E471J	COG	250V	470	± 5%	0.80 ± 0.10
CGA3E3C0G2E561J	COG	250V	560	± 5%	0.80 ± 0.10
CGA3E3C0G2E681J	COG	250V	680	± 5%	0.80 ± 0.10

### Class 2 (Temperature Stable)

Temperature Characteristics: X7R (-55 to +125°C, ±15%), X7S (-55 to +125°C, ±22%), X7T (-55 to +125°C, +22/-33%)

TDK Part Number (Ordering Code)	Temperature Characteristics	Rated Voltage	Capacitance (pF)	Capacitance Tolerance	Thickness (mm)
CGA3E2X7R1H221K	X7R	50V	220	± 10%	0.80 ± 0.10
CGA3E2X7R1H331K	X7R	50V	330	± 10%	0.80 ± 0.10
CGA3E2X7R1H471K	X7R	50V	470	± 10%	0.80 ± 0.10
CGA3E2X7R1H681K	X7R	50V	680	± 10%	0.80 ± 0.10
CGA3E2X7R1H102K	X7R	50V	1,000	± 10%	0.80 ± 0.10
CGA3E2X7R1H152K	X7R	50V	1,500	± 10%	0.80 ± 0.10
CGA3E2X7R1H222K	X7R	50V	2,200	± 10%	0.80 ± 0.10
CGA3E2X7R1H332K	X7R	50V	3,300	± 10%	0.80 ± 0.10



## Capacitance Range Table

## CGA3 [EIA CC0603]

### Class 2 (Temperature Stable)

Temperature Characteristics: X7R (-55 to +125°C, ±15%), X6S (-55 to +105°C, ±22%), X5R (-55 to +85°C, ±15%), Y5V(-30 to +85°C, +22/-82%)

TDK Part Number (Ordering Code)	Temperature Characteristics	Rated Voltage	Capacitance (pF)	Capacitance Tolerance	Thickness (mm)
CGA3E2X7R1H472K	X7R	50V	4,700	± 10%	0.80 ± 0.10
CGA3E2X7R1H682K	X7R	50V	6,800	± 10%	0.80 ± 0.10
CGA3E2X7R1H103K	X7R	50V	10,000	± 10%	0.80 ± 0.10
CGA3E2X7R1H153K	X7R	50V	15,000	± 10%	0.80 ± 0.10
CGA3E2X7R1H223K	X7R	50V	22,000	± 10%	0.80 ± 0.10
CGA3E2X7R1H333K	X7R	50V	33,000	± 10%	0.80 ± 0.10
CGA3E2X7R1H473K	X7R	50V	47,000	± 10%	0.80 ± 0.10
CGA3E2X7R1H683K	X7R	50V	68,000	± 10%	0.80 ± 0.10
CGA3E2X7R1H104K	X7R	50V	100,000	± 10%	0.80 ± 0.10
CGA3E3X7R1H154K	X7R	50V	150,000	± 10%	0.80 ± 0.10
CGA3E3X7R1H224K	X7R	50V	220,000	± 10%	0.80 ± 0.10
CGA3E1X7R1V334K	X7R	35V	330,000	± 10%	0.80 ± 0.10
CGA3E1X7R1V474K	X7R	35V	470,000	± 10%	0.80 ± 0.10
CGA3E2X7R1E104K	X7R	25V	100,000	± 10%	0.80 ± 0.10
CGA3E2X7R1E154K	X7R	25V	150,000	± 10%	0.80 ± 0.10
CGA3E1X7R1E224K	X7R	25V	220,000	± 10%	0.80 ± 0.10
CGA3E3X7R1E474K	X7R	25V	470,000	± 10%	0.80 ± 0.10
CGA3E1X7R1E684K	X7R	25V	680,000	± 10%	0.80 ± 0.10
CGA3E1X7R1E105K	X7R	25V	1,000,000	± 10%	0.80 ± 0.10
CGA3E2X7R1C224K	X7R	16V	220,000	± 10%	0.80 ± 0.10
CGA3E1X7R1C334K	X7R	16V	330,000	± 10%	0.80 ± 0.10
CGA3E1X7R1C474K	X7R	16V	470,000	± 10%	0.80 ± 0.10
CGA3E1X7R1C684K	X7R	16V	680,000	± 10%	0.80 ± 0.10
CGA3E1X5R1C225K	X5R	16V	2,200,000	± 10%	0.80 ± 0.10
CGA3E1X7R0J225K	X7R	6.3V	2,200,000	± 10%	0.80 ± 0.10
CGA3E1X5R0J475K	X5R	6.3V	4,700,000	± 10%	0.80 ± 0.10
CGA3E2X7R2A102K	X7R	100V	1,000	± 10%	0.80 ± 0.10
CGA3E2X7R2A152K	X7R	100V	1,500	± 10%	0.80 ± 0.10
CGA3E2X7R2A222K	X7R	100V	2,200	± 10%	0.80 ± 0.10
CGA3E2X7R2A332K	X7R	100V	3,300	± 10%	0.80 ± 0.10
CGA3E2X7R2A472K	X7R	100V	4,700	± 10%	0.80 ± 0.10
CGA3E2X7R2A682K	X7R	100V	6,800	± 10%	0.80 ± 0.10
CGA3E2X7R2A103K	X7R	100V	10,000	± 10%	0.80 ± 0.10
CGA3E2X7R2A153K	X7R	100V	15,000	± 10%	0.80 ± 0.10
CGA3E2X7R2A223K	X7R	100V	22,000	± 10%	0.80 ± 0.10
CGA3E3X7S2A333K	X7S	100V	33,000	± 10%	0.80 ± 0.10
CGA3E3X7S2A473K	X7S	100V	47,000	± 10%	0.80 ± 0.10
CGA3E3X7S2A683K	X7S	100V	68,000	± 10%	0.80 ± 0.10
CGA3E3X7S2A104K	X7S	100V	100,000	± 10%	0.80 ± 0.10
CGA3E2X8R1E683K	X8R	25V	68,000	± 10%	0.80 ± 0.10
CGA3E2X8R1E104K	X8R	25V	100,000	± 10%	0.80 ± 0.10
CGA3E2X8R1H102K	X8R	50V	1,000	± 10%	0.80 ± 0.10
CGA3E2X8R1H152K	X8R	50V	1,500	± 10%	0.80 ± 0.10
CGA3E2X8R1H222K	X8R	50V	2,200	± 10%	0.80 ± 0.10



## Capacitance Range Table

## CGA3 [EIA CC0603]

### Class 2 (Temperature Stable)

Temperature Characteristics: X7R (-55 to +125°C, ±15%), X6S (-55 to +105°C, ±22%), X5R (-55 to +85°C, ±15%), Y5V(-30 to +85°C, +22/-82%)

TDK Part Number (Ordering Code)	Temperature Characteristics	Rated Voltage	Capacitance (pF)	Capacitance Tolerance	Thickness (mm)
CGA3E2X8R1H332K	X8R	50V	3,300	± 10%	0.80 ± 0.10
CGA3E2X8R1H472K	X8R	50V	4,700	± 10%	0.80 ± 0.10
CGA3E2X8R1H682K	X8R	50V	6,800	± 10%	0.80 ± 0.10
CGA3E2X8R1H103K	X8R	50V	10,000	± 10%	0.80 ± 0.10
CGA3E2X8R1H153K	X8R	50V	15,000	± 10%	0.80 ± 0.10
CGA3E2X8R1H223K	X8R	50V	22,000	± 10%	0.80 ± 0.10
CGA3E2X8R1H333K	X8R	50V	33,000	± 10%	0.80 ± 0.10
CGA3E2X8R1H473K	X8R	50V	47,000	± 10%	0.80 ± 0.10
CGA3E2X8R2A102K	X8R	100V	1,000	± 10%	0.80 ± 0.10
CGA3E2X8R2A152K	X8R	100V	1,500	± 10%	0.80 ± 0.10
CGA3E2X8R2A222K	X8R	100V	2,200	± 10%	0.80 ± 0.10
CGA3E2X8R2A332K	X8R	100V	3,300	± 10%	0.80 ± 0.10
CGA3E2X8R2A472K	X8R	100V	4,700	± 10%	0.80 ± 0.10
CGA3E2X8R2A682K	X8R	100V	6,800	± 10%	0.80 ± 0.10
CGA3E2X8R2A103K	X8R	100V	10,000	± 10%	0.80 ± 0.10
CGA3E2X8R2A153K	X8R	100V	15,000	± 10%	0.80 ± 0.10



## Capacitance Range Chart

## CGA4 [EIA CC0805]

### Capacitance Range Chart

Temperature Characteristics: COG (0±30 ppm/°C)

Rated Voltage: 250V (2E), 100V (2A), 50V (1H)

Capacitance (pF)	Cap Code	Tolerance	COG		
			2E (250V)	2A (100V)	1H (50V)
100	101	J: ± 5%			
220	221				
470	471				
820	821				
1,000	102				
1,200	122				
1,500	152				
1,800	182				
2,200	222				
2,700	272				
3,300	332				
3,900	392				
4,700	472				
5,600	562				
6,800	682				
8,200	822				
10,000	103				
15,000	153				
22,000	223				
33,000	333				

#### Standard Thickness

	0.60 mm
	0.85 mm
	1.25 mm



## Capacitance Range Chart

## CGA4 [EIA CC0805]

### Capacitance Range Chart

Temperature Characteristics: X7R ( $\pm 15\%$ ), X7S ( $\pm 22\%$ ), X8R ( $\pm 15\%$ ), X5R ( $\pm 15\%$ )

Rated Voltage: 450V (2W), 250V (2E), 100V (2A), 50V (1H), 35V (1V), 25V (1E), 16V (1C), 6.3V (0J)

Capacitance (pF)	Cap Code	Tolerance	X7R						
			2E (250V)	2A (100V)	1H (50V)	1V (35V)	1E (25V)	1C (16V)	0J (6.3V)
1,000	102	K: $\pm 10\%$	█	█	█				
1,500	152		█	█					
2,200	222		█	█					
3,300	332		█	█					
4,700	472		█	█					
6,800	682		█	█					
10,000	103		█	█	█				
15,000	153		█	█					
22,000	223		█	█					
33,000	333		█	█					
47,000	473		█	█					
68,000	683		█	█					
100,000	104		█	█	█				
150,000	154		█	█					
220,000	224		█	█			█		
330,000	334		█	█					
470,000	474		█	█	█				
680,000	684		█	█			█	█	
1,000,000	105		█	█		█	█	█	
1,500,000	155		█	█					
2,200,000	225	█	█			█	█		
3,300,000	335	█	█						
4,700,000	475	█	█			█	█		
10,000,000	106	█	█					█	

Capacitance (pF)	Cap Code	Tolerance	X8R			X7S	X7T		X5R
			2A (100V)	1H (50V)	1E (25V)	2A (100V)	2W (450V)	2E (250V)	0J (6.3V)
10,000	103	K: $\pm 10\%$					█		
15,000	153								
22,000	223		█				█		
33,000	333								
47,000	473						█	█	
68,000	683				█				
100,000	104				█			█	
150,000	154					█			
220,000	224					█			
330,000	334								
470,000	474						█		
680,000	684								
1,000,000	105						█		
10,000,000	106								█

Standard Thickness

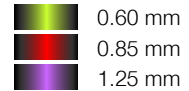





## Capacitance Range Table

## CGA4 [EIA CC0805]

### Class 1 (Temperature Compensating)

Temperature Characteristics: C0G (-55 to 125°C, 0±30 ppm/°C)

TDK Part Number (Ordering Code)	Temperature Characteristics	Rated Voltage	Capacitance (pF)	Capacitance Tolerance	Thickness (mm)
CGA4C2C0G1H101J	C0G	50V	100	± 5%	0.60 ± 0.10
CGA4C2C0G1H102J	C0G	50V	1,000	± 5%	0.60 ± 0.10
CGA4C2C0G1H222J	C0G	50V	2,200	± 5%	0.60 ± 0.10
CGA4C2C0G1H272J	C0G	50V	2,700	± 5%	0.60 ± 0.10
CGA4C2C0G1H332J	C0G	50V	3,300	± 5%	0.60 ± 0.10
CGA4C2C0G1H392J	C0G	50V	3,900	± 5%	0.60 ± 0.10
CGA4F2C0G1H392J	C0G	50V	3,900	± 5%	0.85 ± 0.10
CGA4C2C0G1H472J	C0G	50V	4,700	± 5%	0.60 ± 0.10
CGA4F2C0G1H472J	C0G	50V	4,700	± 5%	0.85 ± 0.10
CGA4C2C0G1H562J	C0G	50V	5,600	± 5%	0.60 ± 0.10
CGA4F2C0G1H562J	C0G	50V	5,600	± 5%	0.85 ± 0.10
CGA4C2C0G1H682J	C0G	50V	6,800	± 5%	0.60 ± 0.10
CGA4J2C0G1H682J	C0G	50V	6,800	± 5%	1.25 ± 0.20
CGA4C2C0G1H822J	C0G	50V	8,200	± 5%	0.60 ± 0.10
CGA4J2C0G1H822J	C0G	50V	8,200	± 5%	1.25 ± 0.20
CGA4C2C0G1H103J	C0G	50V	10,000	± 5%	0.60 ± 0.10
CGA4J2C0G1H103J	C0G	50V	10,000	± 5%	1.25 ± 0.20
CGA4F2C0G1H153J	C0G	50V	15,000	± 5%	0.85 ± 0.10
CGA4J2C0G1H223J	C0G	50V	22,000	± 5%	1.25 ± 0.20
CGA4J2C0G1H333J	C0G	50V	33,000	± 5%	1.25 ± 0.20
CGA4C2C0G2A101J	C0G	100V	100	± 5%	0.60 ± 0.10
CGA4C2C0G2A221J	C0G	100V	220	± 5%	0.60 ± 0.10
CGA4C2C0G2A471J	C0G	100V	470	± 5%	0.60 ± 0.10
CGA4C2C0G2A102J	C0G	100V	1,000	± 5%	0.60 ± 0.10
CGA4C2C0G2A122J	C0G	100V	1,200	± 5%	0.60 ± 0.10
CGA4C2C0G2A152J	C0G	100V	1,500	± 5%	0.60 ± 0.10
CGA4F2C0G2A182J	C0G	100V	1,800	± 5%	0.85 ± 0.10
CGA4F2C0G2A222J	C0G	100V	2,200	± 5%	0.85 ± 0.10
CGA4J2C0G2A272J	C0G	100V	2,700	± 5%	1.25 ± 0.20
CGA4J2C0G2A332J	C0G	100V	3,300	± 5%	1.25 ± 0.20
CGA4J2C0G2A392J	C0G	100V	3,900	± 5%	1.25 ± 0.20
CGA4J2C0G2A472J	C0G	100V	4,700	± 5%	1.25 ± 0.20
CGA4C3C0G2E821J	C0G	250V	820	± 5%	0.60 ± 0.10
CGA4F3C0G2E102J	C0G	250V	1,000	± 5%	0.85 ± 0.10
CGA4F3C0G2E122J	C0G	250V	1,200	± 5%	0.85 ± 0.10
CGA4F3C0G2E152J	C0G	250V	1,500	± 5%	0.85 ± 0.10
CGA4J3C0G2E182J	C0G	250V	1,800	± 5%	1.25 ± 0.20
CGA4J3C0G2E222J	C0G	250V	2,200	± 5%	1.25 ± 0.20
CGA4J3C0G2E272J	C0G	250V	2,700	± 5%	1.25 ± 0.20



## Capacitance Range Table

## CGA4 [EIA CC0805]

### Class 2 (Temperature Stable)

Temperature Characteristics: X7R (-55 to +125°C, ±15%), X6S (-55 to +105°C, ±22%), X5R (-55 to +85°C, ±15%), Y5V(-30 to +85°C, +22/-82%)

TDK Part Number (Ordering Code)	Temperature Characteristics	Rated Voltage	Capacitance (pF)	Capacitance Tolerance	Thickness (mm)
CGA4C2X7R1H102K	X7R	50V	1,000	± 10%	0.60 ± 0.10
CGA4C2X7R1H103K	X7R	50V	10,000	± 10%	0.60 ± 0.10
CGA4F2X7R1H104K	X7R	50V	100,000	± 10%	0.85 ± 0.10
CGA4J2X7R1H104K	X7R	50V	100,000	± 10%	1.25 ± 0.20
CGA4J2X7R1H104KT5	X7R	50V	100,000	± 10%	1.25 ± 0.20
CGA4J2X7R1H154K	X7R	50V	150,000	± 10%	1.25 ± 0.20
CGA4J2X7R1H224K	X7R	50V	220,000	± 10%	1.25 ± 0.20
CGA4J2X7R1H334K	X7R	50V	330,000	± 10%	1.25 ± 0.20
CGA4J3X7R1H474K	X7R	50V	470,000	± 10%	1.25 ± 0.20
CGA4J3X7R1H684K	X7R	50V	680,000	± 10%	1.25 ± 0.20
CGA4J3X7R1H105K	X7R	50V	1,000,000	± 10%	1.25 ± 0.20
CGA4J3X7R1V105K	X7R	35V	1,000,000	± 10%	1.25 ± 0.20
CGA4J1X7R1V225K	X7R	35V	2,200,000	± 10%	1.25 ± 0.20
CGA4J2X7R1E224K	X7R	25V	220,000	± 10%	1.25 ± 0.20
CGA4J2X7R1E474K	X7R	25V	470,000	± 10%	1.25 ± 0.20
CGA4J3X7R1E684K	X7R	25V	680,000	± 10%	1.25 ± 0.20
CGA4J3X7R1E105K	X7R	25V	1,000,000	± 10%	1.25 ± 0.20
CGA4J3X7R1E225K	X7R	25V	2,200,000	± 10%	1.25 ± 0.20
CGA4J1X7R1E335K	X7R	25V	3,300,000	± 10%	1.25 ± 0.20
CGA4J1X7R1E475K	X7R	25V	4,700,000	± 10%	1.25 ± 0.20
CGA4J2X7R1C474K	X7R	16V	470,000	± 10%	1.25 ± 0.20
CGA4J2X7R1C684K	X7R	16V	680,000	± 10%	1.25 ± 0.20
CGA4J2X7R1C105K	X7R	16V	1,000,000	± 10%	1.25 ± 0.20
CGA4J3X7R1C155K	X7R	16V	1,500,000	± 10%	1.25 ± 0.20
CGA4J3X7R1C225K	X7R	16V	2,200,000	± 10%	1.25 ± 0.20
CGA4J3X7R1C475K	X7R	16V	4,700,000	± 10%	1.25 ± 0.20
CGA4J3X5R1A106K	X5R	10V	10,000,000	± 10%	1.25 ± 0.20
CGA4J1X7R0J106K	X7R	6.3V	10,000,000	± 10%	1.25 ± 0.20
CGA4F2X7R2A102K	X7R	100V	1,000	± 10%	0.85 ± 0.10
CGA4F2X7R2A152K	X7R	100V	1,500	± 10%	0.85 ± 0.10
CGA4F2X7R2A222K	X7R	100V	2,200	± 10%	0.85 ± 0.10
CGA4F2X7R2A332K	X7R	100V	3,300	± 10%	0.85 ± 0.10
CGA4F2X7R2A472K	X7R	100V	4,700	± 10%	0.85 ± 0.10
CGA4F2X7R2A682K	X7R	100V	6,800	± 10%	0.85 ± 0.10
CGA4F2X7R2A103K	X7R	100V	10,000	± 10%	0.85 ± 0.10
CGA4J2X7R2A153K	X7R	100V	15,000	± 10%	1.25 ± 0.20
CGA4J2X7R2A223K	X7R	100V	22,000	± 10%	1.25 ± 0.20
CGA4J2X7R2A333K	X7R	100V	33,000	± 10%	1.25 ± 0.20
CGA4J2X7R2A473K	X7R	100V	47,000	± 10%	1.25 ± 0.20
CGA4F2X7R2A683K	X7R	100V	68,000	± 10%	0.85 ± 0.10
CGA4J2X7R2A104K	X7R	100V	100,000	± 10%	1.25 ± 0.20
CGA4F3X7R2E102K	X7R	250V	1,000	± 10%	0.85 ± 0.10
CGA4F3X7R2E152K	X7R	250V	1,500	± 10%	0.85 ± 0.10
CGA4F3X7R2E222K	X7R	250V	2,200	± 10%	0.85 ± 0.10



## Capacitance Range Table

## CGA4 [EIA CC0805]

### Class 2 (Temperature Stable)

Temperature Characteristics: X7R (-55 to +125°C, ±15%), X6S (-55 to +105°C, ±22%), X5R (-55 to +85°C, ±15%), Y5V(-30 to +85°C, +22/-82%)

TDK Part Number (Ordering Code)	Temperature Characteristics	Rated Voltage	Capacitance (pF)	Capacitance Tolerance	Thickness (mm)
CGA4F3X7R2E332K	X7R	250V	3,300	± 10%	0.85 ± 0.10
CGA4F3X7R2E472K	X7R	250V	4,700	± 10%	0.85 ± 0.10
CGA4J3X7R2E682K	X7R	250V	6,800	± 10%	1.25 ± 0.20
CGA4J3X7R2E103K	X7R	250V	10,000	± 10%	1.25 ± 0.20
CGA4J3X7R2E153K	X7R	250V	15,000	± 10%	1.25 ± 0.20
CGA4J3X7R2E223K	X7R	250V	22,000	± 10%	1.25 ± 0.20
CGA4F3X7S2A224K	X7S	100V	220,000	± 10%	0.85 ± 0.10
CGA4J3X7S2A474K	X7S	100V	470,000	± 10%	1.25 ± 0.20
CGA4J3X7S2A105K	X7S	100V	1,000,000	± 10%	1.25 ± 0.20
CGA4J3X7T2E473K	X7T	250V	47,000	± 10%	1.25 ± 0.20
CGA4J3X7T2E104K	X7T	250V	100,000	± 10%	1.25 ± 0.20
CGA4F4X7T2W103K	X7T	450V	10,000	± 10%	0.85 ± 0.10
CGA4J4X7T2W223K	X7T	450V	22,000	± 10%	1.25 ± 0.20
CGA4J4X7T2W473K	X7T	450V	47,000	± 10%	1.25 ± 0.20
CGA4J2X8R1H683K	X8R	50V	68,000	± 10%	1.25 ± 0.20
CGA4J2X8R1H104K	X8R	50V	100,000	± 10%	1.25 ± 0.20
CGA4F2X8R1E154K	X8R	25V	150,000	± 10%	0.85 ± 0.10
CGA4J2X8R1E224K	X8R	25V	220,000	± 10%	1.25 ± 0.20
CGA4J2X8R1E334K	X8R	25V	330,000	± 10%	1.25 ± 0.20
CGA4J2X8R2A223K	X8R	100V	22,000	± 10%	1.25 ± 0.20



## Capacitance Range Chart

## CGA5 [EIA CC1206]





### Capacitance Range Chart

Temperature Characteristics: COG (0±30 ppm/°C)

Rated Voltage: 630V (2J), 250V (2E), 100V (2A), 50V (1H)

Capacitance (pF)	Cap Code	Tolerance	COG			
			2J (630V)	2E (250V)	2A (100V)	1H (50V)
100	101	J: ± 5%	0.60			
120	121					
150	151					
180	181					
220	221					
270	271					
330	331					
390	391					
470	471					
560	561			0.85		
680	681			0.85		
820	821			0.85		
1,000	102			0.85		
1,200	122			0.85		
1,500	152			0.85		
1,800	182			0.85		
2,200	222			0.85		
2,700	272			0.85		
3,300	332			0.85		
3,900	392			0.85		
4,700	472			0.85		
5,600	562			0.85		
6,800	682			0.85		
8,200	822			0.85		
10,000	103				0.60	
15,000	153				0.60	
22,000	223				0.60	
33,000	333				0.85	
47,000	473				0.85	
68,000	683				0.85	
100,000	104				0.85	

#### Standard Thickness

-  0.60 mm
-  0.85 mm
-  1.15 mm
-  1.60 mm



## Capacitance Range Chart

## CGA5 [EIA CC1206]

### Capacitance Range Chart

Temperature Characteristics: X7R ( $\pm 15\%$ ), X7S ( $\pm 22\%$ ), X8R ( $\pm 15\%$ ), X5R ( $\pm 15\%$ )

Rated Voltage: 630V (2J), 450V (2W), 250V (2E), 100V (2A), 50V (1H), 35V (1V), 25V (1E), 16V (1C)

Capacitance (pF)	Cap Code	Tolerance	X7R							
			2J (630V)	2E (250V)	2A (100V)	1H (50V)	1V (35V)	1E (25V)	1C (16V)	
1,000	102	K: $\pm 10\%$	█							
1,500	152									
2,200	222									
3,300	332									
4,700	472									
6,800	682									
10,000	103			█						
15,000	153									
22,000	223			█						
33,000	333			█	█					
47,000	473									
68,000	683				█					
100,000	104									
150,000	154									
220,000	224									
330,000	334									
470,000	474									
680,000	684									
1,000,000	105									█
1,500,000	155									█
2,200,000	225								█	
3,300,000	335								█	
4,700,000	475								█	
6,800,000	685								█	
10,000,000	106								█	

Capacitance (pF)	Cap Code	Tolerance	X7S	X7T		X8R				
			2A (100V)	2J (630V)	2W (450V)	2E (250V)	2A (100V)	1H (50V)	1E (25V)	
10,000	103	K: $\pm 10\%$		█						
15,000	153									
22,000	223				█					
33,000	333									
47,000	473				█					
68,000	683									
100,000	104									
150,000	154									
220,000	224									
330,000	334									
470,000	474									
680,000	684									
1,000,000	105								█	
1,500,000	155								█	
2,200,000	225								█	

Standard Thickness

- 0.85 mm
- 1.15 mm
- 1.30 mm
- 1.60 mm



## Capacitance Range Table

## CGA5 [EIA CC1206]

### Class 1 (Temperature Compensating)

Temperature Characteristics: COG (-55 to 125°C, 0±30 ppm/°C)

TDK Part Number (Ordering Code)	Temperature Characteristics	Rated Voltage	Capacitance (pF)	Capacitance Tolerance	Thickness (mm)
CGA5C2C0G1H472J	COG	50V	4,700	± 5%	0.60 ± 0.10
CGA5C2C0G1H562J	COG	50V	5,600	± 5%	0.60 ± 0.10
CGA5C2C0G1H682J	COG	50V	6,800	± 5%	0.60 ± 0.10
CGA5C2C0G1H822J	COG	50V	8,200	± 5%	0.60 ± 0.10
CGA5F2C0G1H822J	COG	50V	8,200	± 5%	0.85 ± 0.10
CGA5C2C0G1H103J	COG	50V	10,000	± 5%	0.60 ± 0.10
CGA5F2C0G1H103J	COG	50V	10,000	± 5%	0.85 ± 0.10
CGA5C2C0G1H153J	COG	50V	15,000	± 5%	0.60 ± 0.10
CGA5H2C0G1H153J	COG	50V	15,000	± 5%	1.15 ± 0.10
CGA5C2C0G1H223J	COG	50V	22,000	± 5%	0.60 ± 0.10
CGA5H2C0G1H223J	COG	50V	22,000	± 5%	1.15 ± 0.10
CGA5F2C0G1H333J	COG	50V	33,000	± 5%	0.85 ± 0.10
CGA5L2C0G1H333J	COG	50V	33,000	± 5%	1.60 ± 0.30
CGA5H2C0G1H473J	COG	50V	47,000	± 5%	1.15 ± 0.10
CGA5L2C0G1H683J	COG	50V	68,000	± 5%	1.60 ± 0.30
CGA5L2C0G1H104J	COG	50V	100,000	± 5%	1.60 ± 0.30
CGA5C2C0G2A392J	COG	100V	3,900	± 5%	0.60 ± 0.10
CGA5F2C0G2A472J	COG	100V	4,700	± 5%	0.85 ± 0.10
CGA5F2C0G2A562J	COG	100V	5,600	± 5%	0.85 ± 0.10
CGA5H2C0G2A682J	COG	100V	6,800	± 5%	1.15 ± 0.10
CGA5H2C0G2A822J	COG	100V	8,200	± 5%	1.15 ± 0.10
CGA5H2C0G2A103J	COG	100V	10,000	± 5%	1.15 ± 0.10
CGA5F3C0G2E332J	COG	250V	3,300	± 5%	0.85 ± 0.10
CGA5H3C0G2E392J	COG	250V	3,900	± 5%	1.15 ± 0.10
CGA5H3C0G2E472J	COG	250V	4,700	± 5%	1.15 ± 0.10
CGA5H3C0G2E562J	COG	250V	5,600	± 5%	1.15 ± 0.10
CGA5L3C0G2E682J	COG	250V	6,800	± 5%	1.60 ± 0.30
CGA5L3C0G2E822J	COG	250V	8,200	± 5%	1.60 ± 0.30
CGA5C4C0G2J101J	COG	630V	100	± 5%	0.60 ± 0.10
CGA5C4C0G2J121J	COG	630V	120	± 5%	0.60 ± 0.10
CGA5C4C0G2J151J	COG	630V	150	± 5%	0.60 ± 0.10
CGA5C4C0G2J181J	COG	630V	180	± 5%	0.60 ± 0.10
CGA5C4C0G2J221J	COG	630V	220	± 5%	0.60 ± 0.10
CGA5C4C0G2J271J	COG	630V	270	± 5%	0.60 ± 0.10
CGA5C4C0G2J331J	COG	630V	330	± 5%	0.60 ± 0.10
CGA5C4C0G2J391J	COG	630V	390	± 5%	0.60 ± 0.10
CGA5F4C0G2J471J	COG	630V	470	± 5%	0.85 ± 0.10
CGA5F4C0G2J561J	COG	630V	560	± 5%	0.85 ± 0.10
CGA5F4C0G2J681J	COG	630V	680	± 5%	0.85 ± 0.10
CGA5F4C0G2J821J	COG	630V	820	± 5%	0.85 ± 0.10
CGA5F4C0G2J102J	COG	630V	1,000	± 5%	0.85 ± 0.10
CGA5F4C0G2J122J	COG	630V	1,200	± 5%	0.85 ± 0.10
CGA5H4C0G2J152J	COG	630V	1,500	± 5%	1.15 ± 0.10
CGA5H4C0G2J182J	COG	630V	1,800	± 5%	1.15 ± 0.10



## Capacitance Range Table

## CGA5 [EIA CC1206]

### Class 1 (Temperature Compensating)

Temperature Characteristics: C0G (-55 to 125°C, 0±30 ppm/°C)

TDK Part Number (Ordering Code)	Temperature Characteristics	Rated Voltage	Capacitance (pF)	Capacitance Tolerance	Thickness (mm)
CGA5H4C0G2J222J	C0G	630V	2,200	± 5%	1.15 ± 0.10
CGA5L4C0G2J272J	C0G	630V	2,700	± 5%	1.60 ± 0.30
CGA5L4C0G2J332J	C0G	630V	3,300	± 5%	1.60 ± 0.30

### Class 2 (Temperature Stable)

Temperature Characteristics: X7R (-55 to +125°C, ±15%), X6S (-55 to +105°C, ±22%), X5R (-55 to +85°C, ±15%), Y5V(-30 to +85°C, +22/-82%)

TDK Part Number (Ordering Code)	Temperature Characteristics	Rated Voltage	Capacitance (pF)	Capacitance Tolerance	Thickness (mm)
CGA5L2X7R1H474K	X7R	50V	470,000	± 10%	1.60 ± 0.30
CGA5L2X7R1H684K	X7R	50V	680,000	± 10%	1.60 ± 0.30
CGA5L3X7R1H105K	X7R	50V	1,000,000	± 10%	1.60 ± 0.30
CGA5L3X7R1H155K	X7R	50V	1,500,000	± 10%	1.60 ± 0.30
CGA5L3X7R1H225K	X7R	50V	2,200,000	± 10%	1.60 ± 0.30
CGA5L1X7R1V335K	X7R	35V	3,300,000	± 10%	1.60 ± 0.30
CGA5L1X7R1V475K	X7R	35V	4,700,000	± 10%	1.60 ± 0.30
CGA5L2X7R1E105K	X7R	25V	1,000,000	± 10%	1.60 ± 0.30
CGA5L2X7R1E155K	X7R	25V	1,500,000	± 10%	1.60 ± 0.30
CGA5L2X7R1E225K	X7R	25V	2,200,000	± 10%	1.60 ± 0.30
CGA5L1X7R1E335K	X7R	25V	3,300,000	± 10%	1.60 ± 0.30
CGA5L1X7R1E475K	X7R	25V	4,700,000	± 10%	1.60 ± 0.30
CGA5L1X7R1E106K	X7R	25V	10,000,000	± 10%	1.60 ± 0.30
CGA5H2X7R1C105K	X7R	16V	1,000,000	± 10%	1.15 ± 0.10
CGA5L2X7R1C225K	X7R	16V	2,200,000	± 10%	1.60 ± 0.30
CGA5L3X7R1C475K	X7R	16V	4,700,000	± 10%	1.60 ± 0.30
CGA5L1X7R1C685K	X7R	16V	6,800,000	± 10%	1.60 ± 0.30
CGA5H2X7R2A333K	X7R	100V	33,000	± 10%	1.15 ± 0.10
CGA5H2X7R2A473K	X7R	100V	47,000	± 10%	1.15 ± 0.10
CGA5L2X7R2A683K	X7R	100V	68,000	± 10%	1.60 ± 0.30
CGA5L2X7R2A104K	X7R	100V	100,000	± 10%	1.60 ± 0.30
CGA5L2X7R2A154K	X7R	100V	150,000	± 10%	1.60 ± 0.30
CGA5H2X7R2A224K	X7R	100V	220,000	± 10%	1.15 ± 0.10
CGA5K2X7R2A334K	X7R	100V	330,000	± 10%	1.30 ± 0.15
CGA5L2X7R2A474K	X7R	100V	470,000	± 10%	1.60 ± 0.30
CGA5L2X7R2A105K	X7R	100V	1,000,000	± 10%	1.60 ± 0.30
CGA5H3X7R2E153K	X7R	250V	15,000	± 10%	1.15 ± 0.10
CGA5H3X7R2E223K	X7R	250V	22,000	± 10%	1.15 ± 0.10
CGA5L3X7R2E333K	X7R	250V	33,000	± 10%	1.60 ± 0.30
CGA5L3X7R2E473K	X7R	250V	47,000	± 10%	1.60 ± 0.30
CGA5L3X7R2E683K	X7R	250V	68,000	± 10%	1.60 ± 0.30
CGA5L3X7R2E104K	X7R	250V	100,000	± 10%	1.60 ± 0.30
CGA5H4X7R2J102K	X7R	630V	1,000	± 10%	1.15 ± 0.10
CGA5H4X7R2J152K	X7R	630V	1,500	± 10%	1.15 ± 0.10
CGA5H4X7R2J222K	X7R	630V	2,200	± 10%	1.15 ± 0.10
CGA5H4X7R2J332K	X7R	630V	3,300	± 10%	1.15 ± 0.10
CGA5H4X7R2J472K	X7R	630V	4,700	± 10%	1.15 ± 0.10



## Capacitance Range Table

## CGA5 [EIA CC1206]

### Class 2 (Temperature Stable)

Temperature Characteristics: X7R (-55 to +125°C, ±15%), X6S (-55 to +105°C, ±22%), X5R (-55 to +85°C, ±15%), Y5V(-30 to +85°C, +22/-82%)

TDK Part Number (Ordering Code)	Temperature Characteristics	Rated Voltage	Capacitance (pF)	Capacitance Tolerance	Thickness (mm)
CGA5H4X7R2J682K	X7R	630V	6,800	± 10%	1.15 ± 0.10
CGA5H4X7R2J103K	X7R	630V	10,000	± 10%	1.15 ± 0.10
CGA5K4X7R2J153K	X7R	630V	15,000	± 10%	1.30 ± 0.15
CGA5K4X7R2J223K	X7R	630V	22,000	± 10%	1.30 ± 0.15
CGA5L4X7R2J333K	X7R	630V	33,000	± 10%	1.60 ± 0.30
CGA5L3X7S2A225K	X7S	100V	2,200,000	± 10%	1.60 ± 0.30
CGA5L3X7T2E224K	X7T	250V	220,000	± 10%	1.60 ± 0.30
CGA5L4X7T2W104K	X7T	450V	100,000	± 10%	1.60 ± 0.30
CGA5F1X7T2J103K	X7T	630V	10,000	± 10%	0.85 ± 0.10
CGA5H1X7T2J223K	X7T	630V	22,000	± 10%	1.15 ± 0.10
CGA5L1X7T2J473K	X7T	630V	47,000	± 10%	1.60 ± 0.30
CGA5F2X8R1H154K	X8R	50V	150,000	± 10%	0.85 ± 0.10
CGA5H2X8R1H224K	X8R	50V	220,000	± 10%	1.15 ± 0.10
CGA5L2X8R1H334K	X8R	50V	330,000	± 10%	1.60 ± 0.30
CGA5L2X8R1H474K	X8R	50V	470,000	± 10%	1.60 ± 0.30
CGA5F2X8R1E334K	X8R	25V	330,000	± 10%	0.85 ± 0.10
CGA5F2X8R1E474K	X8R	25V	470,000	± 10%	0.85 ± 0.10
CGA5H2X8R1E684K	X8R	25V	680,000	± 10%	1.15 ± 0.10
CGA5L2X8R1E105K	X8R	25V	1,000,000	± 10%	1.60 ± 0.30
CGA5F2X8R2A333K	X8R	100V	33,000	± 10%	0.85 ± 0.10
CGA5F2X8R2A473K	X8R	100V	47,000	± 10%	0.85 ± 0.10
CGA5H2X8R2A683K	X8R	100V	68,000	± 10%	1.15 ± 0.10
CGA5H2X8R2A104K	X8R	100V	100,000	± 10%	1.15 ± 0.10
CGA5L2X8R2A154K	X8R	100V	150,000	± 10%	1.60 ± 0.30





## Capacitance Range Chart

## CGA6 [EIA CC1210]

### Capacitance Range Chart

Temperature Characteristics: COG (0±30 ppm/°C)  
 Rated Voltage: 630V (2J), 250V (2E), 100V (2A), 50V (1H)

Capacitance (pF)	Cap Code	Tolerance	COG			
			2J (630V)	2E (250V)	2A (100V)	1H (50V)
3,900	392	J: ± 5%				
4,700	472					
5,600	562					
6,800	682					
10,000	103					
15,000	153					
22,000	223					
33,000	333					
47,000	473					
68,000	683					
100,000	104					

#### Standard Thickness

	1.30 mm
	1.60 mm
	2.00 mm
	2.30 mm
	2.50 mm

### Capacitance Range Chart

Temperature Characteristics: X7R (± 15%), X7S (± 22%), X8R (±15%), X5R (±15%)  
 Rated Voltage: 630V (2J), 450V (2W), 250V (2E), 100V (2A), 50V (1H), 25V (1E), 16V (1C)

Capacitance (pF)	Cap Code	Tolerance	X7R					
			2J (630V)	2E (250V)	2A (100V)	1H (50V)	1E (25V)	1C (16V)
47,000	473	K: ± 10%						
68,000	683							
100,000	104							
150,000	154							
220,000	224							
330,000	334							
470,000	474							
680,000	684							
1,000,000	105							
1,500,000	155							
2,200,000	225							
3,300,000	335							
4,700,000	475							
6,800,000	685							
10,000,000	106							
15,000,000	156							
22,000,000	226							

Capacitance (pF)	Cap Code	Tolerance	X7S		X7T		X8R
			2A (100V)	1H (50V)	2J (630V)	2W (450V)	1E (25V)
100,000	104	K: ± 10%					
150,000	154						
220,000	224						
330,000	334						
470,000	474						
680,000	684						
1,000,000	105						
1,500,000	155						
2,200,000	225						
3,300,000	335						
4,700,000	475						
6,800,000	685						
10,000,000	106						

#### Standard Thickness

	1.30 mm
	1.60 mm
	2.00 mm
	2.30 mm
	2.50 mm



## Capacitance Range Table

# CGA6 [EIA CC1210]

### Class 1 (Temperature Compensating)

Temperature Characteristics: C0G (-55 to 125°C, 0±30 ppm/°C)

TDK Part Number (Ordering Code)	Temperature Characteristics	Rated Voltage	Capacitance (pF)	Capacitance Tolerance	Thickness (mm)
CGA6J2C0G1H223J	C0G	50V	22,000	± 5%	1.30 ± 0.15
CGA6L2C0G1H333J	C0G	50V	33,000	± 5%	1.60 ± 0.30
CGA6M2C0G1H473J	C0G	50V	47,000	± 5%	2.00 ± 0.20
CGA6M2C0G1H683J	C0G	50V	68,000	± 5%	2.00 ± 0.20
CGA6P2C0G1H104J	C0G	50V	100,000	± 5%	2.50 ± 0.30
CGA6J2C0G2A153J	C0G	100V	15,000	± 5%	1.30 ± 0.15
CGA6L2C0G2A223J	C0G	100V	22,000	± 5%	1.60 ± 0.30
CGA6M2C0G2A333J	C0G	100V	33,000	± 5%	2.00 ± 0.20
CGA6N2C0G2A473J	C0G	100V	47,000	± 5%	2.30 ± 0.20
CGA6L3C0G2E103J	C0G	250V	10,000	± 5%	1.60 ± 0.30
CGA6M3C0G2E153J	C0G	250V	15,000	± 5%	2.00 ± 0.20
CGA6J4C0G2J392J	C0G	630V	3,900	± 5%	1.30 ± 0.15
CGA6L4C0G2J472J	C0G	630V	4,700	± 5%	1.60 ± 0.30
CGA6L4C0G2J562J	C0G	630V	5,600	± 5%	1.60 ± 0.30
CGA6M4C0G2J682J	C0G	630V	6,800	± 5%	2.00 ± 0.20

### Class 2 (Temperature Stable)

Temperature Characteristics: X7R (-55 to +125°C, ±15%), X7S (-55 to +125°C, ±22%), X7T (-55 to +125°C, +22/-33%)

TDK Part Number (Ordering Code)	Temperature Characteristics	Rated Voltage	Capacitance (pF)	Capacitance Tolerance	Thickness (mm)
CGA6L2X7R1H105K	X7R	50V	1,000,000	± 10%	1.60 ± 0.30
CGA6M2X7R1H155K	X7R	50V	1,500,000	± 10%	2.00 ± 0.20
CGA6M3X7R1H225K	X7R	50V	2,200,000	± 10%	2.00 ± 0.20
CGA6P3X7R1H335K	X7R	50V	3,300,000	± 10%	2.50 ± 0.30
CGA6P3X7R1H475K	X7R	50V	4,700,000	± 10%	2.50 ± 0.30
CGA6L2X7R1E335K	X7R	25V	3,300,000	± 10%	1.60 ± 0.30
CGA6M2X7R1E475K	X7R	25V	4,700,000	± 10%	2.00 ± 0.20
CGA6P3X7R1E685K	X7R	25V	6,800,000	± 10%	2.50 ± 0.30
CGA6P1X7R1E106K	X7R	25V	10,000,000	± 10%	2.50 ± 0.30
CGA6P1X7R1E106M	X7R	25V	10,000,000	± 20%	2.50 ± 0.30
CGA6M3X7R1C106K	X7R	16V	10,000,000	± 10%	2.00 ± 0.20
CGA6M3X7R1C106M	X7R	16V	10,000,000	± 20%	2.00 ± 0.20
CGA6P3X7R1C156M	X7R	16V	15,000,000	± 20%	2.50 ± 0.30
CGA6P1X7R1C226M	X7R	16V	22,000,000	± 20%	2.50 ± 0.30
CGA6M2X7R2A334K	X7R	100V	330,000	± 10%	2.00 ± 0.20
CGA6M2X7R2A474K	X7R	100V	470,000	± 10%	2.00 ± 0.20
CGA6L2X7R2A684K	X7R	100V	680,000	± 10%	1.60 ± 0.30
CGA6M2X7R2A105K	X7R	100V	1,000,000	± 10%	2.00 ± 0.20
CGA6N3X7R2A225K	X7R	100V	2,200,000	± 10%	2.30 ± 0.20
CGA6M3X7R2E104K	X7R	250V	100,000	± 10%	2.00 ± 0.20
CGA6M3X7R2E154K	X7R	250V	150,000	± 10%	2.00 ± 0.20
CGA6M3X7R2E224K	X7R	250V	220,000	± 10%	2.00 ± 0.20
CGA6M4X7R2J473K	X7R	630V	47,000	± 10%	2.00 ± 0.20
CGA6M4X7R2J683K	X7R	630V	68,000	± 10%	2.00 ± 0.20
CGA6N3X7S1H475K	X7S	50V	4,700,000	± 10%	2.30 ± 0.20



## Capacitance Range Table

# CGA6 [EIA CC1210]

### Class 2 (Temperature Stable)

Temperature Characteristics: X7R (-55 to +125°C, ±15%), X6S (-55 to +105°C, ±22%), X5R (-55 to +85°C, ±15%), Y5V(-30 to +85°C, +22/-82%)

TDK Part Number (Ordering Code)	Temperature Characteristics	Rated Voltage	Capacitance (pF)	Capacitance Tolerance	Thickness (mm)
CGA6P3X7S1H685K	X7S	50V	6,800,000	± 10%	2.50 ± 0.30
CGA6P3X7S1H106K	X7S	50V	10,000,000	± 10%	2.50 ± 0.30
CGA6M3X7S2A475K	X7S	100V	4,700,000	± 10%	2.00 ± 0.20
CGA6M4X7T2W224K	X7T	450V	220,000	± 10%	2.00 ± 0.20
CGA6L1X7T2J104K	X7T	630V	100,000	± 10%	1.60 ± 0.30
CGA6L2X8R1E155K	X8R	25V	1,500,000	± 10%	1.60 ± 0.30
CGA6M2X8R1E225K	X8R	25V	2,200,000	± 10%	2.00 ± 0.20
CGA6P2X8R1E335K	X8R	25V	3,300,000	± 10%	2.50 ± 0.30



## General Specifications

# CGA Series – Automotive Grade Capacitors

No.	Item	Performance	Test or Inspection Method																	
1	<b>External Appearance</b>	No defects which may affect performance.	Inspect with magnifying glass (3×).																	
2	<b>Insulation Resistance</b>	10,000MΩ or 500MΩ•μF min. (As for the capacitors of rated voltage 16V DC and the item below, 10,000 MΩ or 100MΩ•μF min.), whichever is smaller.	Apply rated voltage for 60s. As for the rated voltage 630V DC, apply 500V DC.																	
3	<b>Voltage Proof</b>	Withstand test voltage without insulation breakdown or other damage.	<table border="1"> <thead> <tr> <th>Class</th> <th>Rated Voltage</th> <th>Apply voltage</th> </tr> </thead> <tbody> <tr> <td rowspan="2">Class 1</td> <td>100V and under</td> <td>3 × rated voltage</td> </tr> <tr> <td>Over 100V</td> <td>1.5 × rated voltage</td> </tr> <tr> <td rowspan="2">Class 2</td> <td>100V and under</td> <td>2.5 × rated voltage</td> </tr> <tr> <td>Over 100V</td> <td>1.5 × rated voltage</td> </tr> </tbody> </table>	Class	Rated Voltage	Apply voltage	Class 1	100V and under	3 × rated voltage	Over 100V	1.5 × rated voltage	Class 2	100V and under	2.5 × rated voltage	Over 100V	1.5 × rated voltage				
			Class	Rated Voltage	Apply voltage															
Class 1	100V and under	3 × rated voltage																		
	Over 100V	1.5 × rated voltage																		
Class 2	100V and under	2.5 × rated voltage																		
	Over 100V	1.5 × rated voltage																		
			Above DC voltage shall be applied for 1 to 5s. Charge / discharge current shall not exceed 50mA.																	
4	<b>Capacitance</b>	Within the specified tolerance.	<table border="1"> <thead> <tr> <th>Class</th> <th>Rated Capacitance</th> <th>Measuring Frequency</th> <th>Measuring voltage</th> </tr> </thead> <tbody> <tr> <td rowspan="2">Class 1</td> <td>≤ 1000pF</td> <td>1MHz±10%</td> <td rowspan="2">0.5 - 5 V<sub>rms</sub></td> </tr> <tr> <td>&gt; 1000pF</td> <td>1kHz±10%</td> </tr> <tr> <td rowspan="2">Class 2</td> <td>≤ 10uF</td> <td>1kHz±10%</td> <td>1.0±0.2 V<sub>rms</sub></td> </tr> <tr> <td>&gt; 10uF</td> <td>120Hz±20%</td> <td>0.5±0.2 V<sub>rms</sub></td> </tr> </tbody> </table>	Class	Rated Capacitance	Measuring Frequency	Measuring voltage	Class 1	≤ 1000pF	1MHz±10%	0.5 - 5 V <sub>rms</sub>	> 1000pF	1kHz±10%	Class 2	≤ 10uF	1kHz±10%	1.0±0.2 V <sub>rms</sub>	> 10uF	120Hz±20%	0.5±0.2 V <sub>rms</sub>
			Class	Rated Capacitance	Measuring Frequency	Measuring voltage														
Class 1	≤ 1000pF	1MHz±10%	0.5 - 5 V <sub>rms</sub>																	
	> 1000pF	1kHz±10%																		
Class 2	≤ 10uF	1kHz±10%	1.0±0.2 V <sub>rms</sub>																	
	> 10uF	120Hz±20%	0.5±0.2 V <sub>rms</sub>																	
5	<b>Q (Class 1)</b>	<table border="1"> <thead> <tr> <th>Rated Capacitance</th> <th>Q</th> </tr> </thead> <tbody> <tr> <td>C ≥ 30pF</td> <td>1,000 min.</td> </tr> <tr> <td>C &lt; 30pF</td> <td>400+20×C min.</td> </tr> </tbody> </table>	Rated Capacitance	Q	C ≥ 30pF	1,000 min.	C < 30pF	400+20×C min.	See No.4 in this table for measuring condition.											
		Rated Capacitance	Q																	
C ≥ 30pF	1,000 min.																			
C < 30pF	400+20×C min.																			
C : Rated capacitance (pF)																				
6	<b>Dissipation Factor (Class 2)</b>	<table border="1"> <thead> <tr> <th>T.C.</th> <th>D.F.</th> </tr> </thead> <tbody> <tr> <td>X8R</td> <td>0.03 max.</td> </tr> <tr> <td>X7R</td> <td>0.05 max.</td> </tr> <tr> <td>C0G</td> <td>0.075 max.</td> </tr> <tr> <td></td> <td>0.1 max.</td> </tr> </tbody> </table>	T.C.	D.F.	X8R	0.03 max.	X7R	0.05 max.	C0G	0.075 max.		0.1 max.	See No.4 in this table for measuring condition.							
		T.C.	D.F.																	
X8R	0.03 max.																			
X7R	0.05 max.																			
C0G	0.075 max.																			
	0.1 max.																			
7	<b>Temperature Characteristics of Capacitance (Class1)</b>	<table border="1"> <thead> <tr> <th>T.C.</th> <th>Temperature Coefficient</th> </tr> </thead> <tbody> <tr> <td>C0G</td> <td>0 ± 30 ppm/°C</td> </tr> </tbody> </table>	T.C.	Temperature Coefficient	C0G	0 ± 30 ppm/°C	Capacitance drift within ± 0.2% or ± 0.05pF, whichever larger.													
		T.C.	Temperature Coefficient																	
C0G	0 ± 30 ppm/°C																			

## CGA Series – Automotive Grade Capacitors

No.	Item	Performance	Test or Inspection Method																
8	<b>Temperature Characteristics of Capacitance (Class 2)</b>	Capacitance Change (%) <table border="1" style="margin-left: 20px;"> <thead> <tr> <th colspan="2">No Voltage Applied</th> </tr> </thead> <tbody> <tr> <td>X7R:</td> <td>± 15%</td> </tr> <tr> <td>X8R:</td> <td>± 15%</td> </tr> </tbody> </table>	No Voltage Applied		X7R:	± 15%	X8R:	± 15%	Capacitance shall be measured by the steps shown in the following table after thermal equilibrium is obtained for each step. $\Delta C$ be calculated ref. STEP 3 reading <table border="1" style="margin-left: 20px;"> <thead> <tr> <th>Step</th> <th>Temperature (°C)</th> </tr> </thead> <tbody> <tr> <td>1</td> <td>Reference temp. ± 2</td> </tr> <tr> <td>2</td> <td>Min. operating temp. ± 3</td> </tr> <tr> <td>3</td> <td>Reference temp. ± 2</td> </tr> <tr> <td>4</td> <td>Max. operating temp. ± 2</td> </tr> </tbody> </table> <p>Measuring voltage: 0.1, 0.2, 0.5, 1.0V<sub>rms</sub>.</p>	Step	Temperature (°C)	1	Reference temp. ± 2	2	Min. operating temp. ± 3	3	Reference temp. ± 2	4	Max. operating temp. ± 2
No Voltage Applied																			
X7R:	± 15%																		
X8R:	± 15%																		
Step	Temperature (°C)																		
1	Reference temp. ± 2																		
2	Min. operating temp. ± 3																		
3	Reference temp. ± 2																		
4	Max. operating temp. ± 2																		

9	<b>Robustness of Terminations</b>	No sign of termination coming off, breakage of ceramic, or other abnormal signs.	Reflow solder the capacitor on P.C. board (shown in Appendix 1a or Appendix 1b) and apply a pushing force of 2N (CGA2) or 17.7N (CGA3, CGA4, CGA5, CGA6) with 10 ± 1s.
---	-----------------------------------	--	--

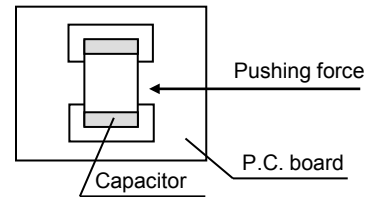

10	<b>Bending</b>	No mechanical damage.	Reflow solder the capacitors on P.C. board (shown in Appendix 2a or Appendix 2b) and bend it for 1mm.
----	----------------	-----------------------	---

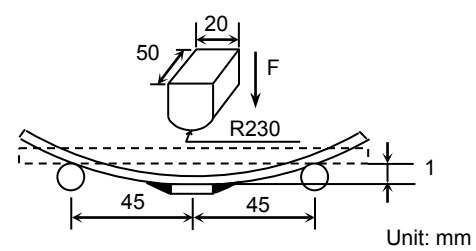

11	<b>Solderability</b>	New solder to cover over 75% of termination.  25% may have pinholes or rough spots but not concentrated in one spot.  Ceramic surface of A sections shall not be exposed due to melting or shifting of termination material.	Completely soak both terminations in solder at 235 ± 5°C for 2 ± 0.5s.  Solder: H63A (JIS Z 3282)  Flux: Isopropyl alcohol (JIS K 8839) Rosin (JIS K 5902) 25% solid solution.
----	----------------------	--	---

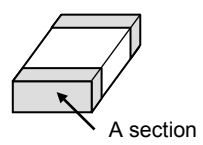



## CGA Series – Automotive Grade Capacitors

No.	Item	Performance	Test or Inspection Method										
12	<b>Resistance to solder heat</b>		Completely soak both terminations in solder at $260 \pm 5^\circ\text{C}$ for $5 \pm 1$ s.  Preheating condition Temp. : $150 \pm 10^\circ\text{C}$ Time : 1 to 2min.  Flux : Isopropyl alcohol (JIS K 8839) Rosin (JIS K 5902) 25% solid solution.  Solder : H63A (JIS Z 3282)  Leave the capacitor in ambient conditions for 6 to 24h (Class 1) or $24 \pm 2$ h (Class 2) before measurement.										
	External appearance	No cracks are allowed and terminations shall be covered at least 60% with new solder											
	Capacitance	<table border="1"> <thead> <tr> <th colspan="2">Characteristics</th> <th>Change from the value before test</th> </tr> </thead> <tbody> <tr> <td>Class 1</td> <td>C0G</td> <td>Capacitance drift within <math>\pm 2.5\%</math> or <math>\pm 0.25\text{pF}</math>, whichever larger.</td> </tr> <tr> <td>Class 2</td> <td>X7R X8R</td> <td><math>\pm 7.5\%</math></td> </tr> </tbody> </table>		Characteristics		Change from the value before test	Class 1	C0G	Capacitance drift within $\pm 2.5\%$ or $\pm 0.25\text{pF}$ , whichever larger.	Class 2	X7R X8R	$\pm 7.5\%$	
		Characteristics		Change from the value before test									
		Class 1		C0G	Capacitance drift within $\pm 2.5\%$ or $\pm 0.25\text{pF}$ , whichever larger.								
	Class 2	X7R X8R		$\pm 7.5\%$									
	Q (Class 1)	<table border="1"> <thead> <tr> <th>Rated Capacitance</th> <th>Q</th> </tr> </thead> <tbody> <tr> <td>30pF and over</td> <td>1,000 min.</td> </tr> <tr> <td>Under 30pF</td> <td><math>400 + 20 \times C</math> min.</td> </tr> </tbody> </table> <p style="text-align: center;">C : Rated capacitance (pF)</p>		Rated Capacitance	Q	30pF and over	1,000 min.	Under 30pF	$400 + 20 \times C$ min.				
	Rated Capacitance	Q											
	30pF and over	1,000 min.											
	Under 30pF	$400 + 20 \times C$ min.											
D.F. (Class 2)	Meet the initial spec.												
Insulation Resistance	Meet the initial spec.												
Voltage Proof	No insulation breakdown or other damage.												
13	<b>Vibration</b>		Reflow solder the capacitor on a P.C. board (shown in Appendix 1a or Appendix 1b) before testing.  Vibrate the capacitor with following conditions:  Applied force: 5G max. Frequency: 10-2000Hz Duration: 20 min. Cycle : 12 cycles										
	External appearance	No mechanical damage.											
	Capacitance	<table border="1"> <thead> <tr> <th colspan="2">Characteristics</th> <th>Change from the value before test</th> </tr> </thead> <tbody> <tr> <td>Class 1</td> <td>C0G</td> <td>Capacitance drift within <math>\pm 2.5\%</math> or <math>\pm 0.25\text{pF}</math>, whichever larger.</td> </tr> <tr> <td>Class 2</td> <td>X7R X8R</td> <td><math>\pm 7.5\%</math></td> </tr> </tbody> </table>		Characteristics		Change from the value before test	Class 1	C0G	Capacitance drift within $\pm 2.5\%$ or $\pm 0.25\text{pF}$ , whichever larger.	Class 2	X7R X8R	$\pm 7.5\%$	
		Characteristics		Change from the value before test									
		Class 1		C0G	Capacitance drift within $\pm 2.5\%$ or $\pm 0.25\text{pF}$ , whichever larger.								
	Class 2	X7R X8R		$\pm 7.5\%$									
Q (Class 1)	<table border="1"> <thead> <tr> <th>Rated Capacitance</th> <th>Q</th> </tr> </thead> <tbody> <tr> <td>30pF and over</td> <td>1,000 min.</td> </tr> <tr> <td>Under 30pF</td> <td><math>400 + 20 \times C</math> min.</td> </tr> </tbody> </table> <p style="text-align: center;">C : Rated capacitance (pF)</p>		Rated Capacitance	Q	30pF and over	1,000 min.	Under 30pF	$400 + 20 \times C$ min.					
Rated Capacitance	Q												
30pF and over	1,000 min.												
Under 30pF	$400 + 20 \times C$ min.												
D.F. (Class 2)	Meet the initial spec.												



## General Specifications

# CGA Series – Automotive Grade Capacitors

No.	Item	Performance	Test or Inspection Method														
14	<b>Temperature cycle</b>																
	External appearance	No mechanical damage.	Reflow solder the capacitors on a P.C. board (shown in Appendix 1a or Appendix 1b) before testing. Expose the capacitor in the conditions step1 through step 4, and repeat 5 times consecutively.														
	Capacitance	<table border="1"> <thead> <tr> <th colspan="2">Characteristics</th> <th>Change from the value before test</th> </tr> </thead> <tbody> <tr> <td>Class 1</td> <td>C0G</td> <td>Capacitance drift within <math>\pm 2.5\%</math> or <math>\pm 0.25\text{pF}</math>, whichever larger.</td> </tr> <tr> <td>Class 2</td> <td>X7R X8R</td> <td><math>\pm 7.5\%</math></td> </tr> </tbody> </table>		Characteristics		Change from the value before test	Class 1	C0G	Capacitance drift within $\pm 2.5\%$ or $\pm 0.25\text{pF}$ , whichever larger.	Class 2	X7R X8R	$\pm 7.5\%$	Leave the capacitor in ambient conditions for 6 to 24h (Class 1) or $24 \pm 2\text{h}$ (Class 2) before measurement.				
		Characteristics		Change from the value before test													
		Class 1	C0G	Capacitance drift within $\pm 2.5\%$ or $\pm 0.25\text{pF}$ , whichever larger.													
	Class 2	X7R X8R	$\pm 7.5\%$														
	<table border="1"> <thead> <tr> <th>Step</th> <th>Temperature (°C)</th> <th>Time (min.)</th> </tr> </thead> <tbody> <tr> <td>1</td> <td>Min. operating temp. <math>\pm 3</math></td> <td><math>30 \pm 3</math></td> </tr> <tr> <td>2</td> <td>Reference Temp. <math>\pm 2</math></td> <td>2 – 5</td> </tr> <tr> <td>3</td> <td>Max. operating temp. <math>\pm 2</math></td> <td><math>30 \pm 2</math></td> </tr> <tr> <td>4</td> <td>Reference Temp. <math>\pm 2</math></td> <td>2 - 5</td> </tr> </tbody> </table>		Step	Temperature (°C)	Time (min.)	1	Min. operating temp. $\pm 3$	$30 \pm 3$	2	Reference Temp. $\pm 2$	2 – 5	3	Max. operating temp. $\pm 2$	$30 \pm 2$	4	Reference Temp. $\pm 2$	2 - 5
	Step	Temperature (°C)	Time (min.)														
	1	Min. operating temp. $\pm 3$	$30 \pm 3$														
	2	Reference Temp. $\pm 2$	2 – 5														
3	Max. operating temp. $\pm 2$	$30 \pm 2$															
4	Reference Temp. $\pm 2$	2 - 5															
Q (Class 1)	<table border="1"> <thead> <tr> <th>Rated Capacitance</th> <th>Q</th> </tr> </thead> <tbody> <tr> <td>30pF and over</td> <td>1,000 min.</td> </tr> <tr> <td>Under 30pF</td> <td><math>400+20 \times C</math> min.</td> </tr> </tbody> </table> <p style="text-align: center;">C : Rated capacitance (pF)</p>	Rated Capacitance	Q	30pF and over	1,000 min.	Under 30pF	$400+20 \times C$ min.										
Rated Capacitance	Q																
30pF and over	1,000 min.																
Under 30pF	$400+20 \times C$ min.																
D.F. (Class 2)	Meet the initial spec.																
Insulation Resistance	Meet the initial spec.																
Voltage proof	No insulation breakdown or other damage.																
15	<b>Moisture Resistance</b>																
	External appearance	No mechanical damage.	Reflow solder the capacitor on P.C. board (shown in Appendix 1a or Appendix 1b) before testing. Apply the rated voltage at temperature 85°C and 85%RH for 1000 +24,0h. Charge/discharge current shall not exceed 50mA.														
	Capacitance	<table border="1"> <thead> <tr> <th colspan="2">Characteristics</th> <th>Change from the value before test</th> </tr> </thead> <tbody> <tr> <td>Class 1</td> <td>C0G</td> <td>Capacitance drift within <math>\pm 7.5\%</math> or <math>\pm 0.75\text{pF}</math>, whichever larger.</td> </tr> <tr> <td>Class 2</td> <td>X7R X8R</td> <td><math>\pm 12.5\%</math></td> </tr> </tbody> </table>		Characteristics		Change from the value before test	Class 1	C0G	Capacitance drift within $\pm 7.5\%$ or $\pm 0.75\text{pF}$ , whichever larger.	Class 2	X7R X8R	$\pm 12.5\%$	Leave the capacitor in ambient conditions for 6 to 24h (Class 1) or $24 \pm 2\text{h}$ (Class 2) before measurement. Voltage conditioning (only for Class 2): Voltage treat the capacitor under testing temperature and voltage for 1 hour. Leave the capacitor in ambient conditions for $24 \pm 2\text{h}$ before measurement. Use this measurement for initial value.				
		Characteristics		Change from the value before test													
		Class 1	C0G	Capacitance drift within $\pm 7.5\%$ or $\pm 0.75\text{pF}$ , whichever larger.													
	Class 2	X7R X8R	$\pm 12.5\%$														
	<table border="1"> <thead> <tr> <th>Rated Capacitance</th> <th>Q</th> </tr> </thead> <tbody> <tr> <td>30pF and over</td> <td>1,000 min.</td> </tr> <tr> <td>Under 30pF</td> <td><math>100+10/3 \times C</math> min.</td> </tr> </tbody> </table> <p style="text-align: center;">C : Rated capacitance (pF)</p>		Rated Capacitance	Q	30pF and over	1,000 min.	Under 30pF	$100+10/3 \times C$ min.									
	Rated Capacitance	Q															
	30pF and over	1,000 min.															
	Under 30pF	$100+10/3 \times C$ min.															
Q (Class 1)																	
D.F. (Class 2)	Characteristics X7R: 200% of initial spec. max. X8R: 200% of initial spec. max																
Insulation Resistance	500MΩ or 25MΩ·μF min. (As for the capacitors of rated voltage 16V DC and item below, 500MΩ or 5MΩ·μF min.,) whichever smaller.																



No.	Item	Performance	Test or Inspection Method										
16	<b>Life</b>												
	External appearance	No mechanical damage.	Reflow solder the capacitor on P.C. board (shown in Appendix 1a or Appendix 1b) before testing. Test condition : maximum operating temperature $\pm 2^{\circ}\text{C}$ for 1,000 +48,0h.										
	Capacitance	<table border="1" style="width: 100%;"> <thead> <tr> <th colspan="2">Characteristics</th> <th>Change from the value before test</th> </tr> </thead> <tbody> <tr> <td>Class 1</td> <td>C0G</td> <td>Capacitance drift within <math>\pm 7.5\%</math> or <math>\pm 0.75\text{pF}</math>, whichever larger.</td> </tr> <tr> <td>Class 2</td> <td>X7R X8R</td> <td><math>\pm 15\%</math></td> </tr> </tbody> </table>		Characteristics		Change from the value before test	Class 1	C0G	Capacitance drift within $\pm 7.5\%$ or $\pm 0.75\text{pF}$ , whichever larger.	Class 2	X7R X8R	$\pm 15\%$	Please refer to each part number for test voltage. Charge/discharge current shall not exceed 50mA. Leave the capacitor in ambient conditions for 6 to 24h (Class 1) or $24 \pm 2\text{h}$ (Class 2) before measurement. Voltage conditioning: Voltage treat the capacitors under testing temperature and voltage for 1 hour.
		Characteristics		Change from the value before test									
		Class 1	C0G	Capacitance drift within $\pm 7.5\%$ or $\pm 0.75\text{pF}$ , whichever larger.									
	Class 2	X7R X8R	$\pm 15\%$										
Q (Class 1)	<table border="1" style="width: 100%;"> <thead> <tr> <th>Rated Capacitance</th> <th>Q</th> </tr> </thead> <tbody> <tr> <td><math>C \geq 30\text{pF}</math></td> <td>350 min.</td> </tr> <tr> <td><math>10\text{pF} \leq C &lt; 30\text{pF}</math></td> <td><math>275 + 5/2 \times C</math> min.</td> </tr> <tr> <td><math>C &lt; 10\text{pF}</math></td> <td><math>200 + 10 \times C</math> min.</td> </tr> </tbody> </table>		Rated Capacitance	Q	$C \geq 30\text{pF}$	350 min.	$10\text{pF} \leq C < 30\text{pF}$	$275 + 5/2 \times C$ min.	$C < 10\text{pF}$	$200 + 10 \times C$ min.	Leave the capacitor in ambient conditions on for $24 \pm 2\text{h}$ before measurement. Use this measurement for initial value.		
	Rated Capacitance	Q											
	$C \geq 30\text{pF}$	350 min.											
$10\text{pF} \leq C < 30\text{pF}$	$275 + 5/2 \times C$ min.												
$C < 10\text{pF}$	$200 + 10 \times C$ min.												
C : Rated capacitance (pF)													
D.F. (Class 2)	Characteristics X7R: 200% of initial spec. max. X8R: 200% of initial spec. max												
Insulation Resistance	1,000M $\Omega$ or 50M $\Omega \cdot \mu\text{F}$ min. , whichever smaller. (As for the capacitors of rated voltage 16 DC, 1,000 M $\Omega$ or 10M $\Omega \cdot \mu\text{F}$ min.,)												

**\*As for the initial measurement of capacitors (Class 2) on number 8, 12, 13 and 14, leave capacitors at 150 –10, 0°C for 1 hour and measure the value after leaving capacitor for 24±2h in ambient conditions.**





### Appendix - 1a

#### P.C. Board for reliability test

Applied for CGA2, CGA3, CGA4, CGA5

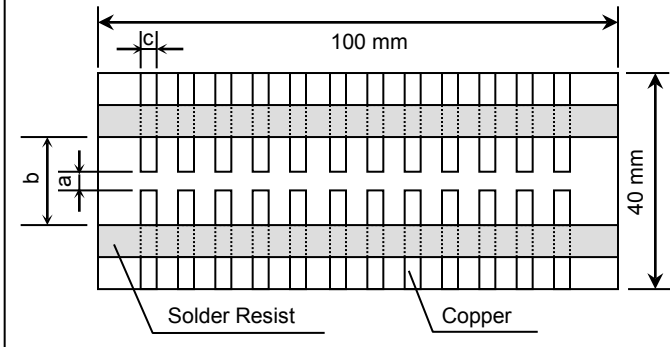

### Appendix - 1b

#### P.C. Board for reliability test

Applied for CGA6

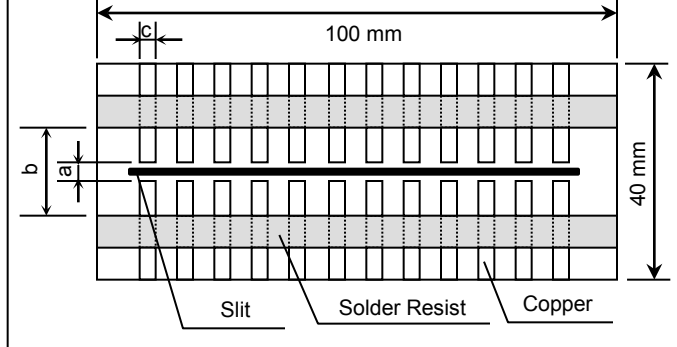

### Appendix - 2a

#### P.C. Board for bending test

Applied for CGA2

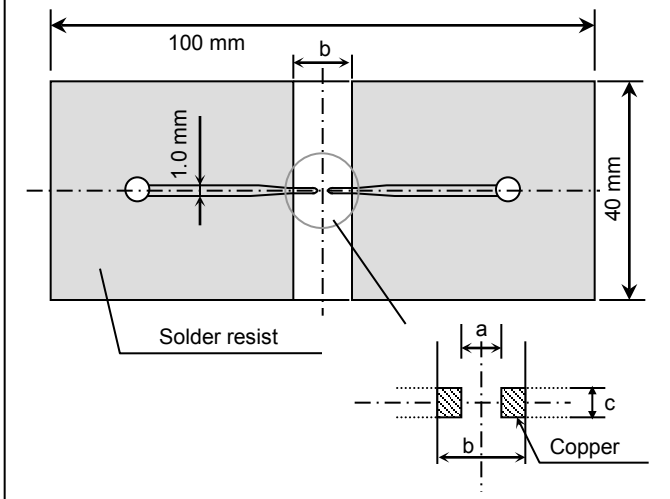

### Appendix - 2b

#### P.C. Board for bending test

Applied for CGA3, CGA4, CGA5, CGA6

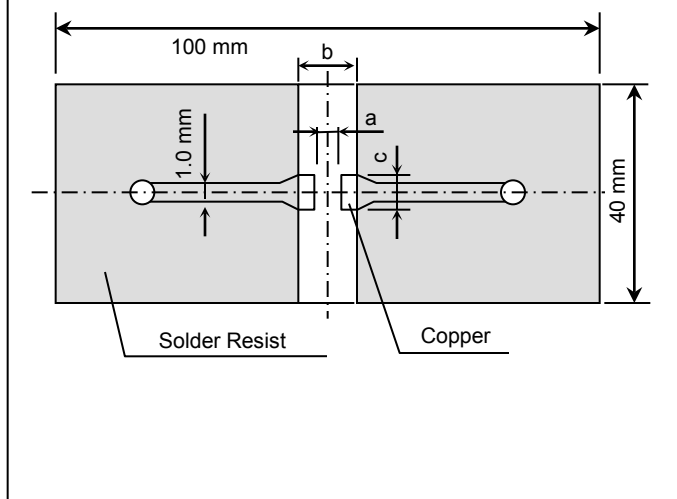

Material : Glass Epoxy ( As per JIS C6484 GE4 )

P.C. Board thickness : Appendix-2a                      0.8mm  
    Appendix-1a, 1b, 2b                      1.6mm

- Copper ( thickness 0.035mm )
- Solder resist

Case Code			Dimensions (mm)		
Series	JIS	EIA	a	b	c
CGA2	C1005	CC0402	0.4	1.5	0.5
CGA3	C1608	CC0603	1.0	3.0	1.2
CGA4	C2012	CC0805	1.2	4.0	1.65
CGA5	C3216	CC1206	2.2	5.0	2.0
CGA6	C3225	CC1210	2.2	5.0	2.9

## CGA Series – Automotive Grade Capacitors

### Recommended Soldering Land Pattern

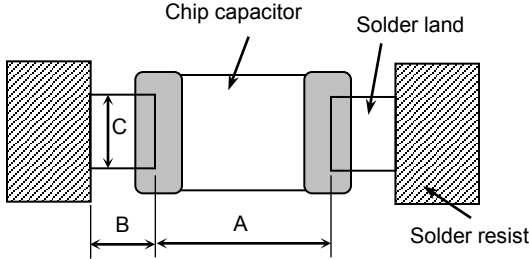

Wave Soldering		Unit: mm		
Type	CGA3	CGA4	CGA5	
Symbol	[CC0603]	[CC0805]	[CC1206]	
A	0.7 - 1.0	1.0 - 1.3	2.1 - 2.5	
B	0.8 - 1.0	1.0 - 1.2	1.1 - 1.3	
C	0.6 - 0.8	0.8 - 1.1	1.0 - 1.3	

Reflow Soldering		Unit: mm		
Type	CGA2	CGA3	CGA4	
Symbol	[CC0402]	[CC0603]	[CC0805]	
A	0.3 - 0.5	0.6 - 0.8	0.9 - 1.2	
B	0.35 - 0.45	0.6 - 0.8	0.7 - 0.9	
C	0.4 - 0.6	0.6 - 0.8	0.9 - 1.2	

Reflow Soldering		Unit: mm	
Type	CGA5	CGA6	
Symbol	[CC1206]	[CC1210]	
A	2.0 - 2.4	2.0 - 2.4	
B	1.0 - 1.2	1.0 - 1.2	
C	1.1 - 1.6	1.9 - 2.5	

### Recommended Solder Amount

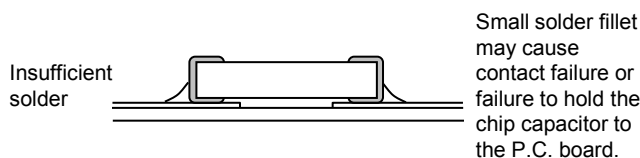
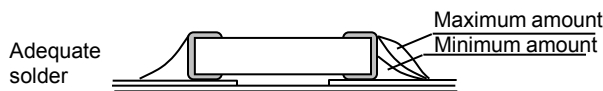
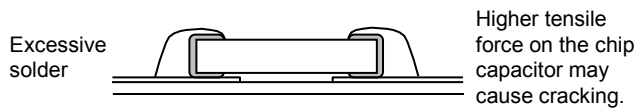

### Recommended Soldering Profile

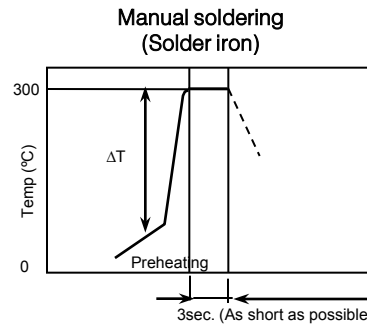
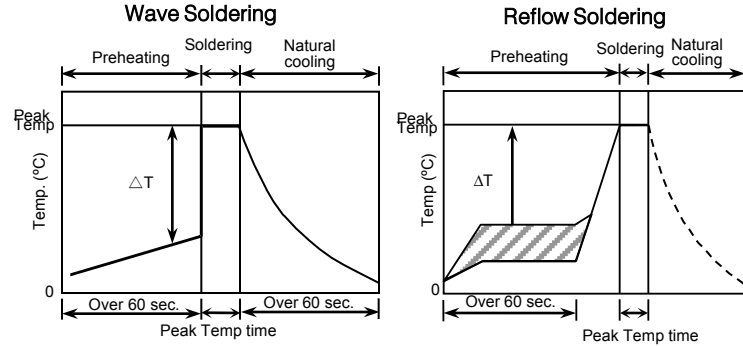

### Recommended soldering duration

Solder	Temp./Dura.	Wave Soldering		Reflow Soldering	
		Peak temp (°C)	Duration (sec.)	Peak temp (°C)	Duration (sec.)
Sn-Pb Solder		250 max.	3 max.	230 max.	20 max.
Lead-Free Solder		260 max.	5 max.	260 max.	10 max.

### Recommended solder compositions

- Sn-37Pb (Sn-Pb solder)
- Sn-3.0Ag-0.5Cu (Lead Free Solder)

### Preheating Condition

Soldering	Case Size - JIS (EIA)	Temp. (°C)
Wave soldering	CGA3(CC0603), CGA4(CC0805), CGA5(CC1206)	$\Delta T \leq 150$
Reflow soldering	CGA2(CC0402), CGA3(CC0603), CGA4(CC0805), CGA5(CC1206)	$\Delta T \leq 150$
	CGA6(CC1210)	$\Delta T \leq 130$
Manual soldering	CGA2(CC0402), CGA3(CC0603), CGA4(CC0805), CGA5(CC1206)	$\Delta T \leq 150$
	CGA6(CC1210)	$\Delta T \leq 130$



## Packaging Information

# CGA Series – Automotive Grade Capacitors

### Carrier Tape Configuration

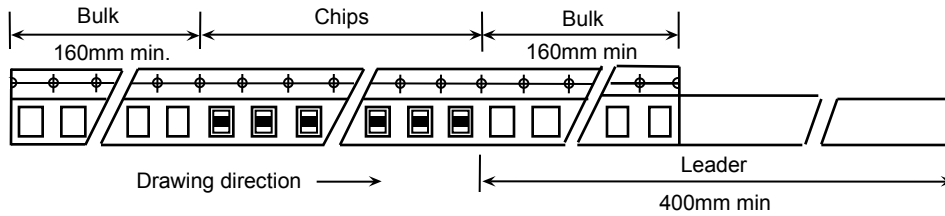

### Peel Back Force (Top Tape)

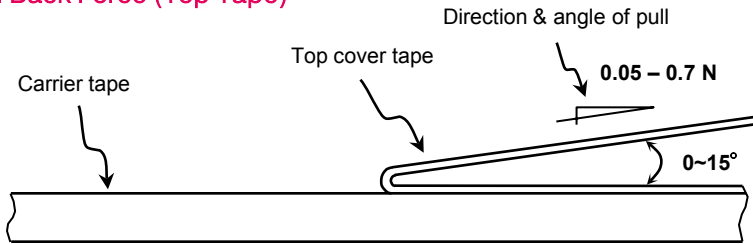

- Carrier tape shall be flexible enough to be wound around a minimum radius of 30mm with components in tape.
- The missing of components shall be less than 0.1%
- Components shall not stick to the cover tape.
- The cover tape shall not protrude beyond the edges of the carrier tape and shall not cover the sprocket holes.

### Chip Quantity Per Reel and Structure of Reel (Paper & Plastic)

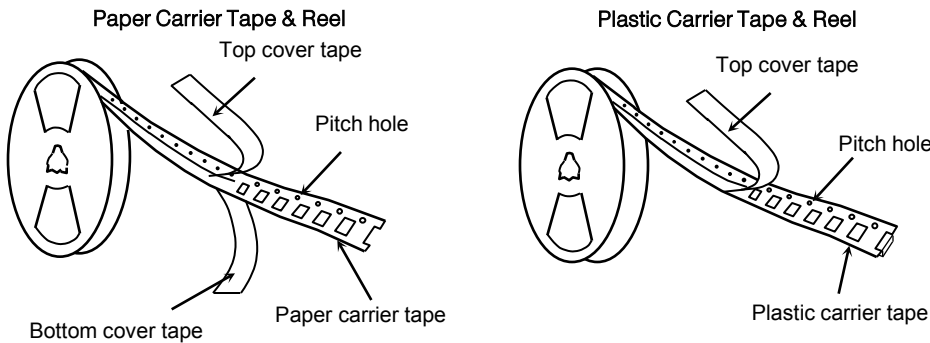

Case Code			Chip Thickness (mm)	Taping Material	Chip quantity (pcs.)	
Series	JIS	EIA			φ178mm (7") reel	φ330mm (13") reel
CGA2	C1005	CC0402	0.50	Paper	10,000	50,000
CGA3	C1608	CC0603	0.80		4,000	10,000
CGA4	C2012	CC0805	0.60	Plastic	2,000	20,000
			0.85			
			1.25	Paper	4,000	10,000
0.60						
0.85						
CGA5	C3216	CC1206	1.15	Plastic	2,000	8,000
			1.60			
			1.25			
CGA6	C3225	CC1210	1.60	Plastic	1,000	5,000
			2.00			
			2.30			
			2.50			



## Additional Information

# CGA Series – Automotive Grade Capacitors

### • Shape & Dimensions

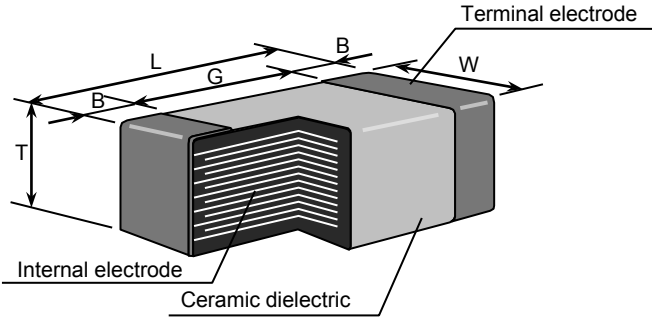

### • Inside Structure & Material System

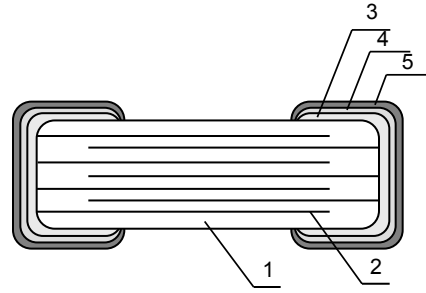

Case Code			Dimensions (mm)				
Series	JIS	EIA	L	W	T	B	G
CGA2	C1005	CC0402	1.00	0.50	0.50	0.25	0.30 min.
CGA3	C1608	CC0603	1.60	0.80	0.80	0.30	0.50 min.
CGA4	C2012	CC0805	2.00	1.25	0.85	0.20 min.	0.50 min.
					1.25		
CGA5	C3216	CC1206	3.20	1.60	0.60	0.30 min.	1.00 min.
					0.85		
					1.15		
CGA6	C3225	CC1210	3.20	2.50	1.60	0.20 min.	1.00 min.
					1.25		
					2.00		
					2.30		
					2.50	0.30 min.	

No.	NAME	MATERIAL	
		Class 1	Class 2
(1)	Ceramic Dielectric	CaZrO <sub>3</sub>	BaTiO <sub>3</sub>
(2)	Internal Electrode	Nickel (Ni)	
(3)	Termination	Copper (Cu)	
(4)		Nickel (Ni)	
(5)		Tin (Sn)	

### • Environmental Information

TDK Corporation established internal product environmental assurance standards that include the six hazardous substances banned by the EU RoHS Directive<sup>1</sup> enforced on July 1, 2006 along with additional substances independently banned by TDK and has successfully completed making general purpose electronic components conform to the RoHS Directive<sup>2</sup>.

1. Abbreviation for Restriction on Hazardous Substances, which refers to the regulation EU Directive 2002/95/EC on hazardous substances by the European Union (EU) effective from July 1, 2006. The Directive bans the use of six specific hazardous substances in electric and electronic devices and products handled within the EU. The six substances are lead, mercury, cadmium, hexavalent chromium, PBB (polybrominated biphenyls), and PBDE (polybrominated diphenyl ethers).
2. This means that, in conformity with the EU Directive 2002/95/EC, lead, cadmium, mercury, hexavalent chromium, and specific bromine-based flame retardants, PBB and PBDE, have not been used, except for exempted applications.

For REACH (SVHC : 15 substances according to ECHA / October 2008) : All TDK MLCC do not contain these 15 substances.

For European Directive 2000/53/CE and 2005/673/CE : Cadmium, Hexavalent Chromium, Mercury, Lead are not contained in all TDK MLCC.

For European Directive 2003/11/CE : Pentabromodiphenyl-ether, Octabromodiphenyl-ether are not contained in all TDK MLCC.