



Product Description

RFMD's CGA-3318Z is a high performance Silicon Germanium HBT MMIC Amplifier. Designed with SiGe process technology for excellent linearity at an exceptional price. A Darlington configuration is utilized for broadband performance. The hetero-junction increases breakdown voltage and minimizes leakage current between junctions. The CGA-3318Z contains two amplifiers for use in wideband Push-Pull CATV amplifiers requiring excellent second order performance. The second and third order non-linearities are greatly improved in the push-pull configuration.

Optimum Technology Matching® Applied

- GaAs HBT
- GaAs MESFET
- InGaP HBT
- SiGe BiCMOS
- Si BiCMOS
- SiGe HBT
- GaAs pHEMT
- Si CMOS
- Si BJT
- GaN HEMT
- InP HBT

Amplifier Configuration

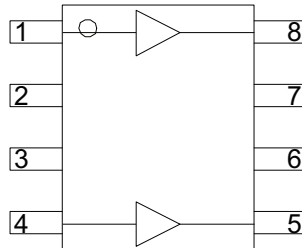

Features

- Lead-Free, RoHS Compliant, and Green Packaging
- Excellent CSO/CTB/XMOD Performance at +34dBmV Output Power Per Tone
- Dual Devices in Each SOIC-8 Package Simplify Push-Pull Configuration PC Board Layout
- 5 MHz to 900 MHz Operation

Applications

- CATV Head End Driver and Predriver Amplifier
- CATV Line Driver Amplifier

Parameter	Specification			Unit	Condition
	Min.	Typ.	Max.		
Small Signal Gain		13.2		dB	5MHz
		12.5		dB	50MHz and 500MHz
	10.0	12.0		dB	870MHz
OIP ₂ , Tone Spacing=1MHz		69.0		dBm	50MHz, P _{OUT} per tone = +6dBm
		71.5		dBm	250MHz, P _{OUT} per tone
	67.0	69.0		dBm	500MHz, P _{OUT} per tone
OIP ₃ , Tone Spacing=1MHz		36.5		dBm	50MHz, P _{OUT} per tone = +6dBm
		38.0		dBm	500MHz, P _{OUT} per tone = +6dBm
	36.0	38.0		dBm	870MHz, P _{OUT} per tone = +6dBm
Output Power at 1dB Compression		20.0		dBm	50MHz
		21.0		dBm	500MHz
	18.6	20.6		dBm	870MHz
Input Return Loss		17.0		dBm	500MHz
	10			dBm	50 - 870MHz
Output Return Loss		12.0		dB	500MHz
	10			dB	50 - 870MHz
Noise Figure		4.2		dB	50MHz, Balun Insertion Loss Included
		4.3		dB	500MHz, Balun Insertion Loss Included
		5.0	6.0	dB	870MHz, Balun Insertion Loss Included
Device Operating Voltage	3.9	4.1	4.3	V	
Device Operating Current	135	150	165	mA	
Thermal Resistance		50		°C/W	(Junction to Lead)

Absolute Maximum Ratings

Parameter	Rating	Unit
Max Device Current (I_D)	225	mA
Max Device Voltage (VD)	6	V
Max RF Input Power	+18	dBm
Max Junction Temp (TJ)	+150	°C
Operating Temp Range (TL)	-40 to +85	°C
Max Storage Temp	+150	°C
ESD Rating - Human Body Model (HBM)	1B	Class
Moisture Sensitivity Level	3	MSL



Caution! ESD sensitive device.

Exceeding any one or a combination of the Absolute Maximum Rating conditions may cause permanent damage to the device. Extended application of Absolute Maximum Rating conditions to the device may reduce device reliability. Specified typical performance or functional operation of the device under Absolute Maximum Rating conditions is not implied.

RoHS status based on EUDirective2002/95/EC (at time of this document revision).

The information in this publication is believed to be accurate and reliable. However, no responsibility is assumed by RF Micro Devices, Inc. ("RFMD") for its use, nor for any infringement of patents, or other rights of third parties, resulting from its use. No license is granted by implication or otherwise under any patent or patent rights of RFMD. RFMD reserves the right to change component circuitry, recommended application circuitry and specifications at any time without prior notice.

*Note: Load condition1, $Z_L = 50\Omega$. Load condition2, $Z_L = 10:1$ VSWR.

Operation of this device beyond any one of these limits may cause permanent damage. For reliable continuous operation, the device voltage and current must not exceed the maximum operating values specified in the table on page one.

Bias Conditions should also satisfy the following expression:

$$I_D V_D < (T_J - T_L) / R_{TH, J-H} \text{ and } T_L = T_{LEAD}$$

Parameter	Specification			Unit	Condition
	Min.	Typ.	Max.		
Worst Case Over Band, CSO		70		dBc	79 Ch., Flat, +34dBmV
Worst Case Over Band, CTB		68		dBc	79 Ch., Flat, +34dBmV
Worst Case Over Band, XMOD		63		dBc	79 Ch., Flat, +34dBmV

Typical RF Performance: $V_S=8V$, $I_D=150mA$ @ $T_L=+25^\circ C$, $R_{BIAS}=51$ Ohms, Push-Pull Configuration

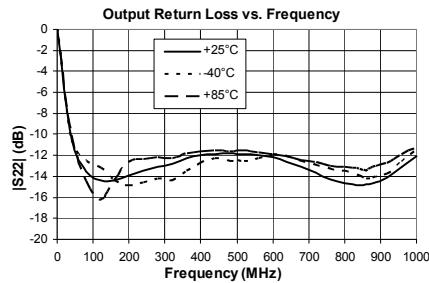
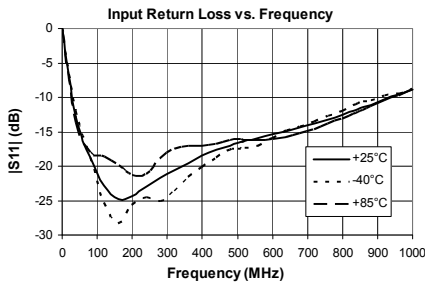
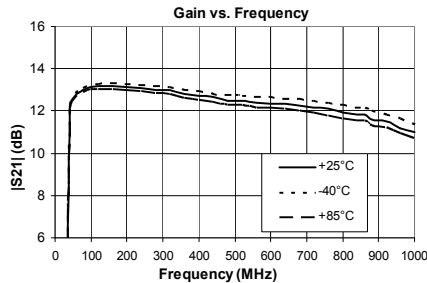

Typical RF Performance: $V_s=8V$, $I_D=150mA$ @ $T_L=+25^\circ C$, $R_{BIAS}=51$ Ohms, Push-Pull Configuration

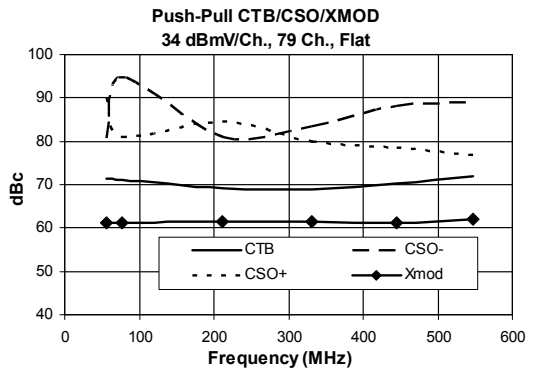
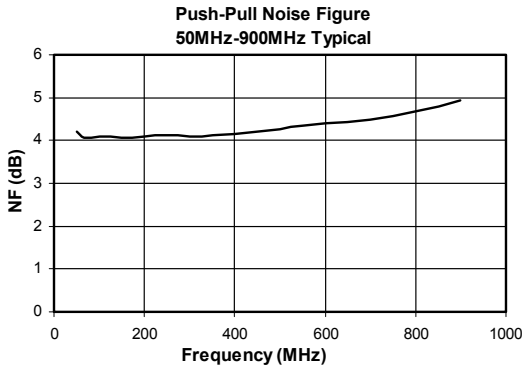
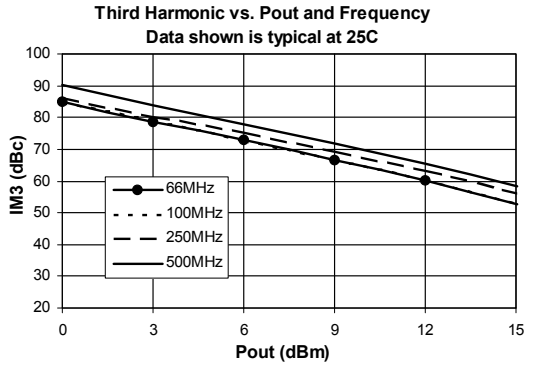
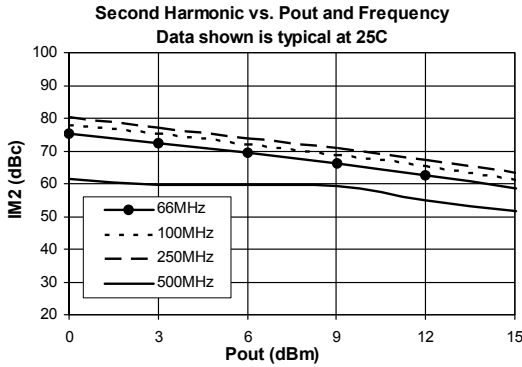
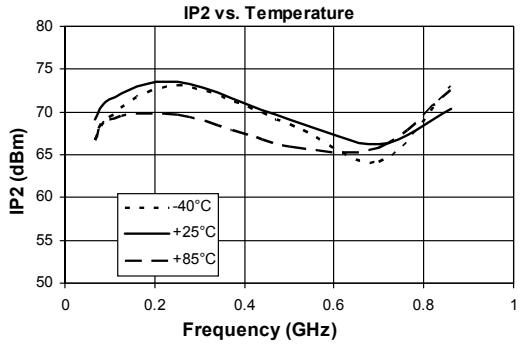
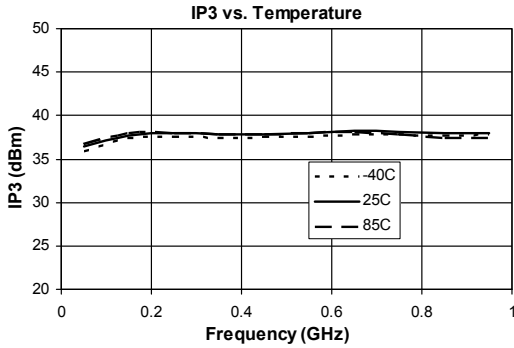

CSO/CTB/XMOD Performance:

$V_s=8V$, $I_b=150mA$ @ $T_L=+25^\circ C$, $R_{BIAS}=51$ Ohms, Push-Pull Config, 79 Ch. Flat Analog, No Digital Channels.

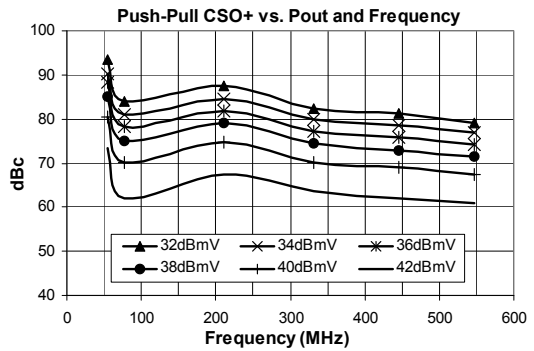
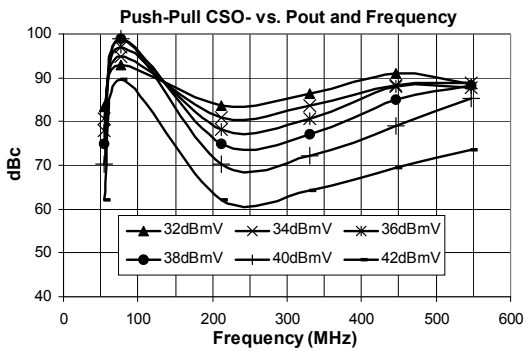
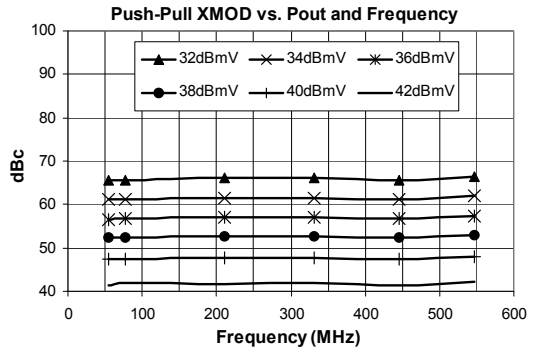
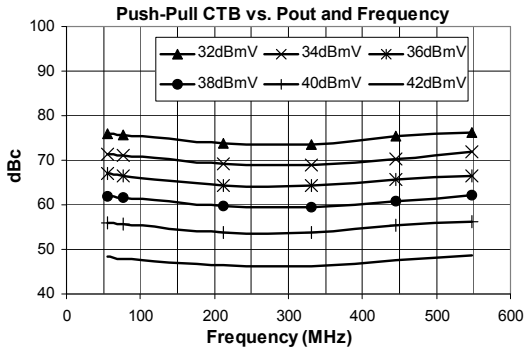

Note: CSO measurements > 85 dBc can be limited by system noise.

Typical RF Performance - Single Ended - 50 Ohm System

$V_s=8V$, $I_o=75mA$ (one amp biased), $T_L=+25^\circ C$, $R_{BIAS}=51$ Ohms

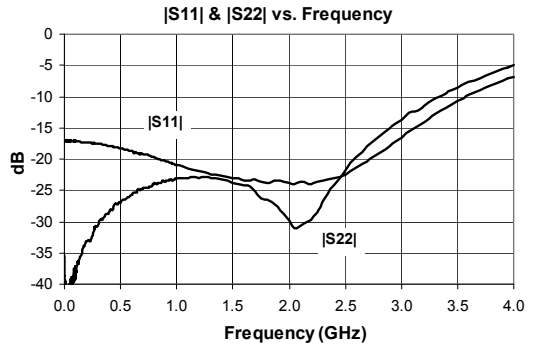
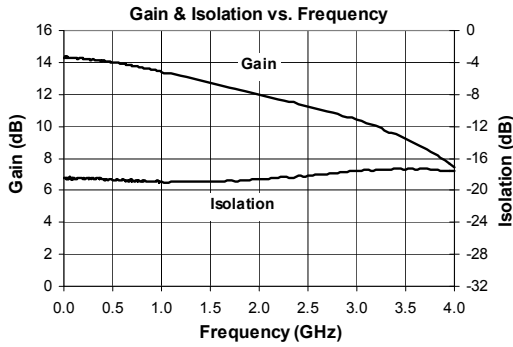

Typical RF Performance - Single Ended - 37.5 Ohm System

$V_s=8V$, $I_o=75mA$ (one amp biased), $T_L=+25^\circ C$, $R_{BIAS}=51$ Ohms

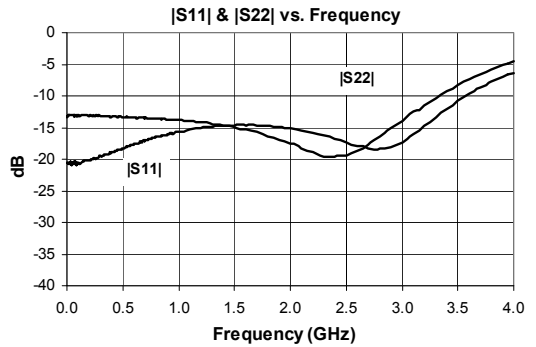
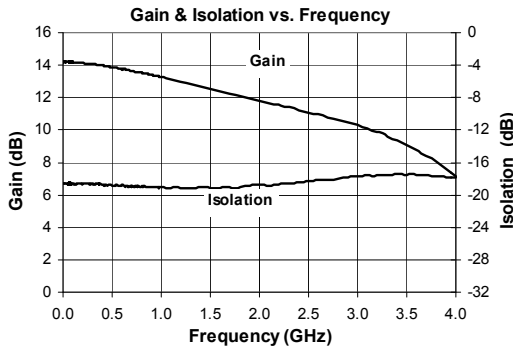

50 MHz to 870 MHz Application Circuit Schematic

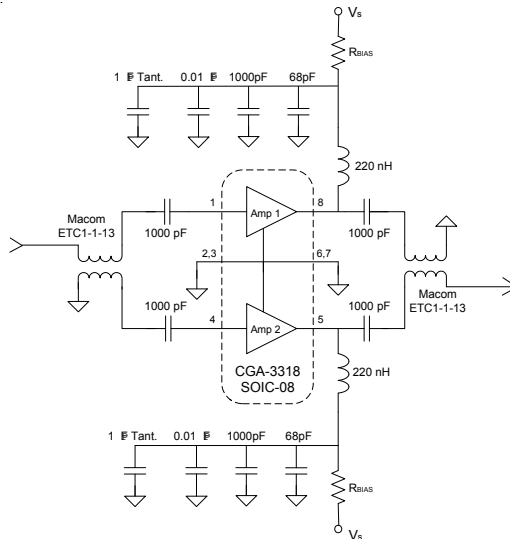

50 MHz to 870 MHz Evaluation Board Layout

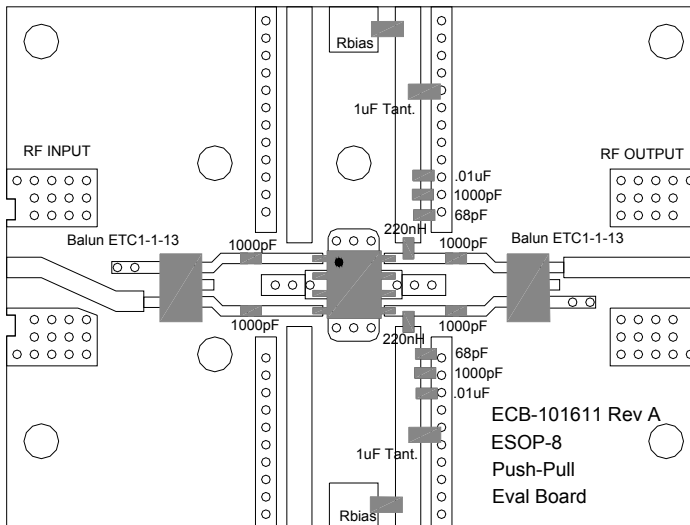

5 MHz to 210 MHz Application Circuit Schematic

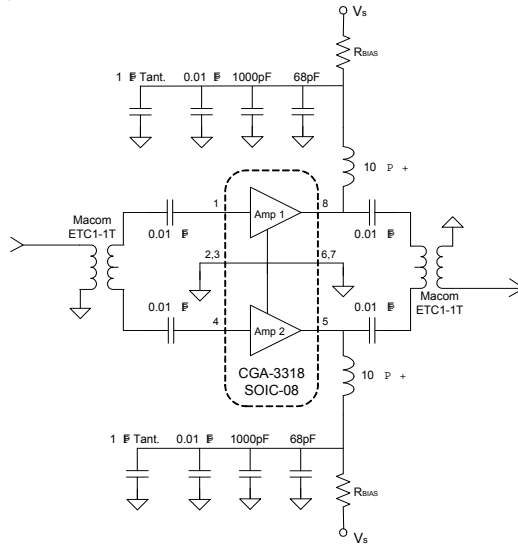

5 MHz to 100 MHz Evaluation Board Layout

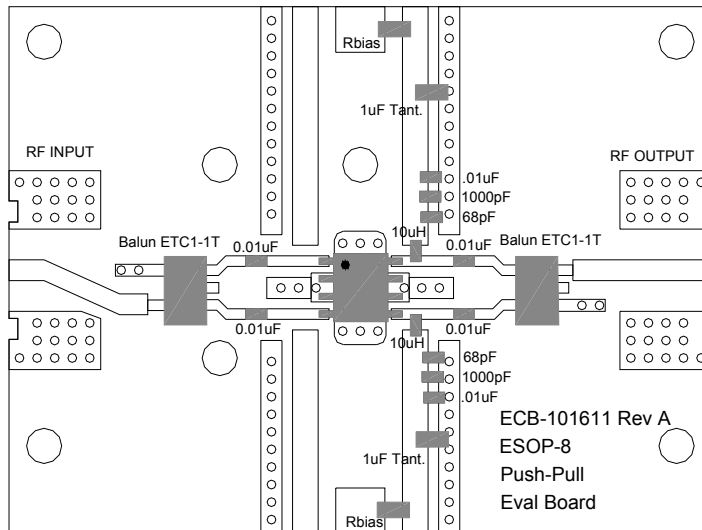

Recommended Bias Resistor Values for ID= 150mA				
Supply Voltage (V _S)	8V	9V	12V	15V
R _{BIAS}	51	:	:	
R _{BIAS} Power Rating	1/2W	1/2W	1W	1W

$$R_{BIAS} = \frac{2(V_S - V_D)}{I_D}$$

Typical 5-100 MHz RF Performance: V_S=8V, I_D=150mA @ T_L=+25°C, Push-Pull Configuration

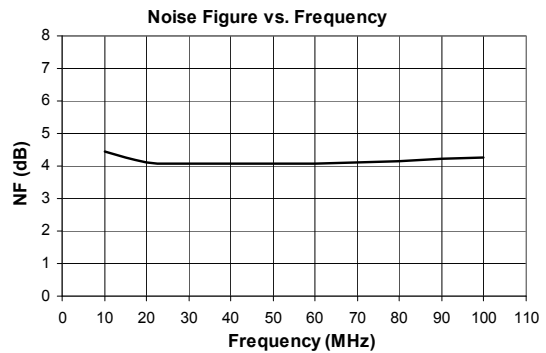
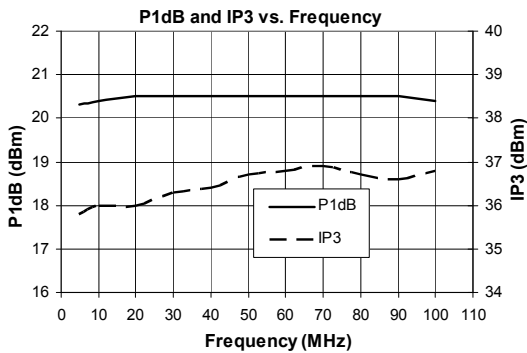
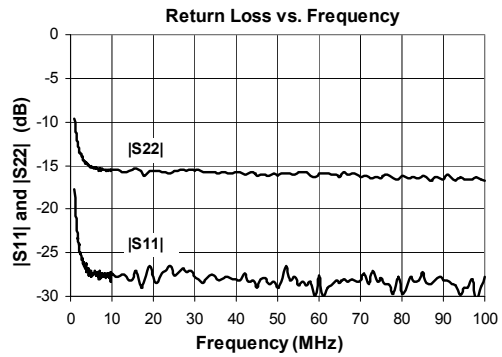
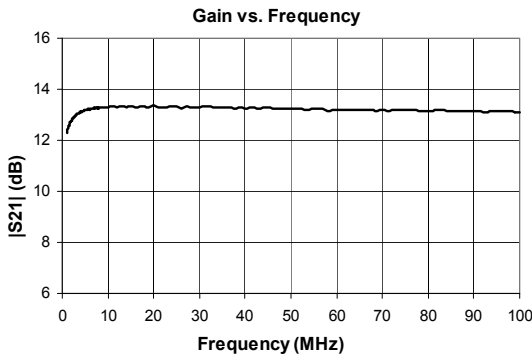

Pin	Function	Description
1	RF IN	Device 1. RF input pin. This pin requires the use of an external DC-blocking capacitor as shown in the schematic.
2, 3	GND	Connection to ground. Use via holes for best performance to reduce lead inductance as close to ground leads as possible.
4	RF IN	Device 2. RF input pin. This pin requires the use of an external DC-blocking capacitor as shown in the schematic.
5	RF OUT/VCC	Device 2. RF output and bias pin. Bias should be supplied to this pin through an external series resistor and RF choke inductor. Because DC biasing is present on this pin, a DC-blocking capacitor should be used in most applications. The supply side of the bias network should be well bypassed.
6, 7	GND	Same as pins 2 and 3.
8	RF OUT/VCC	Device 1. Same as pin 5.
EPAD	GND	Exposed area on the bottom side of the package must be soldered to the ground plane of the board for optimum thermal and RF performance. Several vias should be located under the EPAD as shown in the recommended land pattern.

Device Pin Out

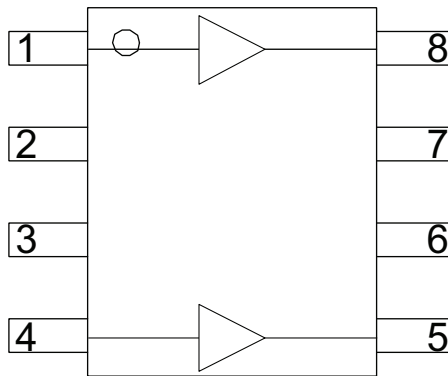

Suggested Pad Layout

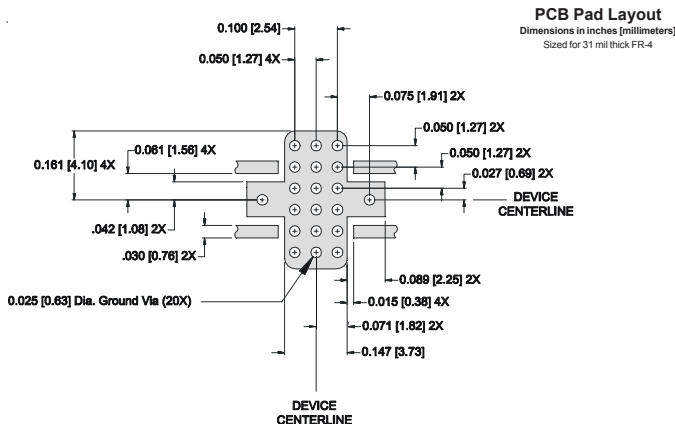

Package Drawing and Marking

Dimensions in inches (millimeters)

Refer to drawing posted at www.rfmd.com for tolerances.

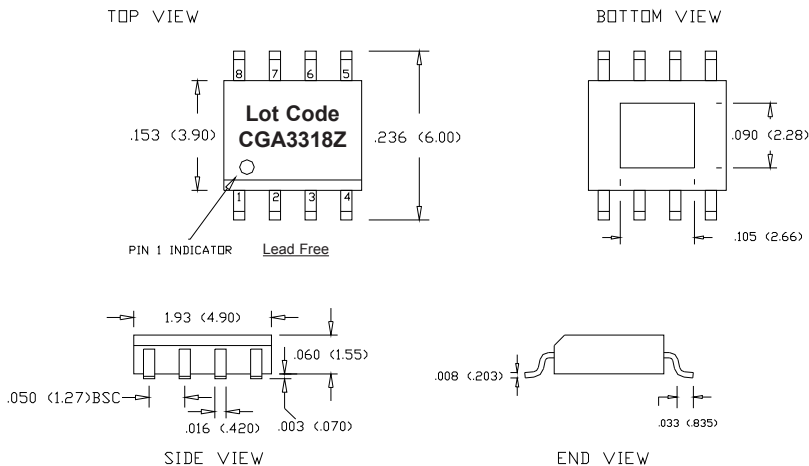

Ordering Information

Part Number	Description	Reel Size	Devices/Reel
CGA3318ZSB	5 pcs Sample Bag	N/A	N/A
CGA3318ZSQ	25 pcs Sample Bag	N/A	N/A
CGA3318ZSR	Dual CATV Broadband HBT AMP	7"	100 pcs
CGA3318Z	Dual CATV Broadband HBT AMP	7"	500 pcs
CGA3318ZPCK-410	50MHz to 870MHz Eval Bd & 5 Loose Pieces	N/A	N/A
CGA3318ZPCK-411	5MHz to 100MHz Eval Bd & 5 Loose Pieces	N/A	N/A