

CGJ series | High Reliability Series

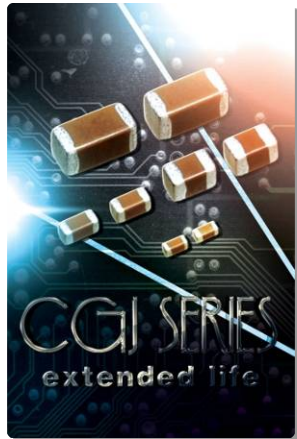

Contents

- Purpose / Objectives
- TDK MLCC Lineup
- Series Concept
- Cap Range
- Features
- Applications
- Design Tools/Resources
- Part Number Description
- Summary



CGJ series | High Reliability Series

Purpose

- To provide a general overview of TDK's "CGJ High Reliability Series" Capacitor

Objectives

- Define TDK's CGJ High Reliability Series capacitors
- Highlight the features and applications of TDK's CGJ Series Capacitors
- Explain TDK's CGJ series part number structure

SERIES		FEATURES	OFFERING
	General Applications	<ul style="list-style-type: none"> Wide range of case size and superior dimension precision Available in EIA class 1 and 2 dielectrics up to 50V 	<ul style="list-style-type: none"> 01005 ~ 2220 / C0G, SL, X5R, X6S, X7R, X7S, Y5V 4V ~ 50V / up to 100 μF
	Mid Voltage	<ul style="list-style-type: none"> Unique design allows for higher voltage in smaller case size Available in 100V, 250V, 450V, and 630V 	<ul style="list-style-type: none"> 0402 ~ 2220 / C0G, X6S, X7R, X7S, X7T 100V ~ 630V / up to 15 μF
	High Voltage	<ul style="list-style-type: none"> Advance design provides improved withstanding voltage Available rating up to 3000V 	<ul style="list-style-type: none"> 1808 ~ 1812 / C0G, X7R, X8S 1000V ~ 3000V / up to 10 nF
	High Temperature	<ul style="list-style-type: none"> Stable temperature characteristics up to 150°C Highly precise temperature performance (\pm 7.5%) up to 125° C 	<ul style="list-style-type: none"> 0402 ~ 1210 / X8R 16V ~ 100V / up to 10 μF
	High Q	<ul style="list-style-type: none"> Design with higher Q factor than standard capacitors Excellent attenuation and high self resonance frequency (SRF) 	<ul style="list-style-type: none"> 0201 / C0G 25V / up to 20 pF
	Flip Type	<ul style="list-style-type: none"> Flipped geometry provides lower inductance than standard capacitor Special design allows for adequate high frequency current to IC 	<ul style="list-style-type: none"> 0204 ~ 0612 / X5R, X6S, X7R, X7S 4V ~ 50V / up to 10 μF
	Open Mode	<ul style="list-style-type: none"> Unique design allows for increase resistance to mechanical bending Improved performance in vibration and electrical stresses 	<ul style="list-style-type: none"> 0805 ~ 2220 / X7R, X8R 16V ~ 630V / up to 22 μF
	Soft Termination	<ul style="list-style-type: none"> Improved bending resistance and temperature cycle performance Termination technology available for most case sizes including arrays 	<ul style="list-style-type: none"> 0805 ~ 3025 / X7R, X7S, X7T 16V ~ 630V / up to 100 μF
	Conductive Epoxy	<ul style="list-style-type: none"> AgPdCu termination for conductive glue mounting Improved mechanical/thermal strength when used with conductive glue 	<ul style="list-style-type: none"> 0402 ~ 1210 / C0G, X7R, X8R 25V ~ 100V / up to 10 μF
	CER	Controlled ESR	<ul style="list-style-type: none"> Unique design allows for specified "controlled" ESR Same no-hassle mounting method as standard 2-terminal components ESR is controlled without affecting the ESL
CEU	Serial Design	<ul style="list-style-type: none"> 2 series-connected capacitors in one body Improved bending resistance and temperature cycle performance Ultra high reliability design for automotive battery line applications 	<ul style="list-style-type: none"> 0603 ~ 0805 / X7R 50V / up to 100 nF
CGA	Automotive Applications	<ul style="list-style-type: none"> Qualified to CDF AEC Q-200 automotive testing standard Manufactured using matured process for guaranteed performance Available in C0G, X7R and X8R temperature characteristics 	<ul style="list-style-type: none"> 0402 ~ 2220 / C0G, X5R, X7R, X7S, X7T, X8R 6.3V ~ 630V / up to 47 μF
CGJ	High Reliability Applications	<ul style="list-style-type: none"> Extensive testing to ensure higher reliability and longer life Reliability tests based on MIL-STD requirements Guaranteed TC Bias and Hot IR performance 	<ul style="list-style-type: none"> 0402 ~ 1206 / C0G, X7R 6.3V ~ 50V / up to 10 μF
CKC	2-in-1 Array 4-in-1 Array	<ul style="list-style-type: none"> Allows for reduction of PCB space and mounting time Unique electrode design reduces crosstalk Also available in soft termination for higher reliability performance 	<ul style="list-style-type: none"> CKCN27 ~ CKCA43 / C0G, X5R, X7R 6.3V ~ 50V / up to 2.2 μF
CKD	Feed Through	<ul style="list-style-type: none"> Optimized for noise bypass with signal and power source circuits Can be used for meeting EMC requirements Ideal for use at higher frequencies due to low parasitic inductance 	<ul style="list-style-type: none"> 0402 ~ 1206 / up to 125°C temperature range 6.3V ~ 50V / up to 22 μF
CKG	Mega Cap	<ul style="list-style-type: none"> Advance design for twice the capacitance on single footprint Improved vibration and thermal/mechanical stress performance Lower ESR and ESL than ALU and TA capacitor 	<ul style="list-style-type: none"> CKGxxK ~ CKGxxN / X5R, X7R, X7S, X7T 16V ~ 630V / up to 100 μF
CLL	Ultra Low Inductance	<ul style="list-style-type: none"> Unique internal structure allows cancelation of magnetic fields to reduce equivalent series inductance Eight sided terminal electrode design in one capacitor 	<ul style="list-style-type: none"> 0603 ~ 0805 / X7R, X7S 4V ~ 10V / up to 4.7 μF

CGJ series | High Reliability Series- Series Concept -

Concept Image

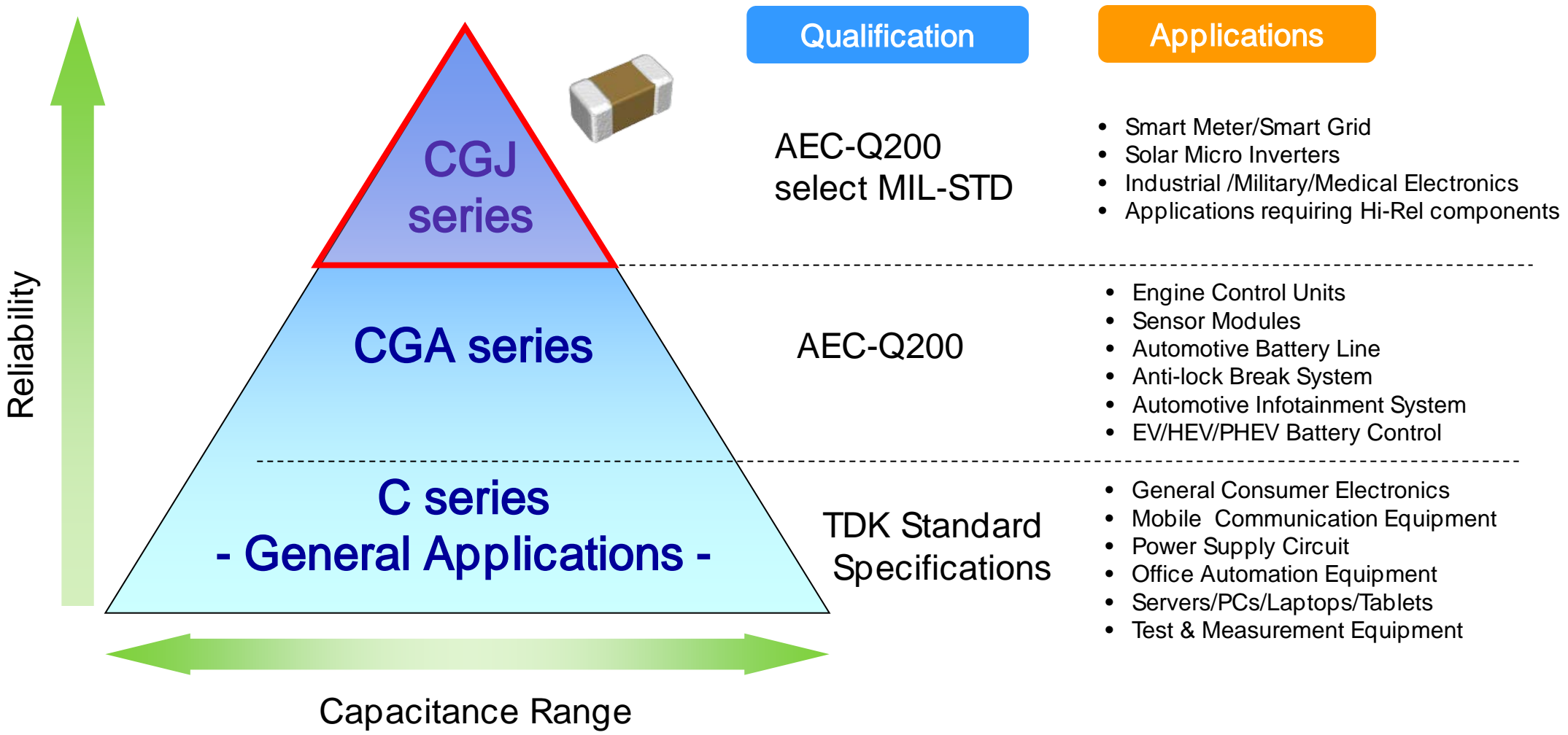

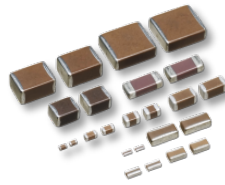

**Commercial Grade
C Series**

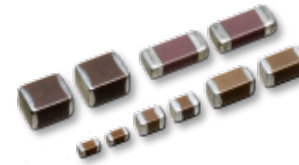

**Automotive Grade
CGA Series**

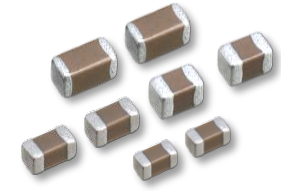

**High Reliability Grade
CGJ Series**

Insulation Resistance	● 100% of each lot	● 100% of each lot	● 100% of each lot
Voltage Proof Test (DWV)	● 100% of each lot	● 100% of each lot	● 100% of each lot
Capacitance / Dissipation Factor (DF, Q)	● 100% of each lot	● 100% of each lot	● 100% of each lot
External Appearance / Visual Inspection	⊙ Sampled each lot	● 100%	● 100%
Physical Dimension	⊙ Sampled each lot	⊙ Sampled each lot	⊙ Sampled each lot
Solderability	⊙ Sampled each lot	⊙ Sampled each lot	⊙ Sampled each lot
Temperature Characteristics	⊙ Qualification Only	⊙ Qualification Only	⊙ Sampled each lot (n=10)
Deflection (Bending; Board Flex)	⊙ Qualification Only	⊙ Qualification Only	⊙ Sampled each lot (n=10)
Operating Life	⊙ Qualification Only	⊙ Qualification (X•RV for 1,000 hrs)	⊙ Qualification (X•RV for 2,000 hrs)
Bias Humidity	-	⊙ Qualification (RV only)	⊙ Qualification (RV and LV)
Destructive Physical Analysis (DPA)	-	⊙ Qualification Only	⊙ Sampled each lot (n=10)
Highly Accelerated Life Test (HALT)	-	-	⊙ Sampled each lot (n=60)
DC Bias / ESR / Breakdown Voltage	-	-	⊙ Qualification Only (n=50)
Salt Water Immersion / Tin Whisker	-	-	⊙ Qualification Only

*Please refer to TDK Specifications (www.tdk.com) and Certificate of Compliance for more detail on test method and acceptance criteria as well as sampled lot size.

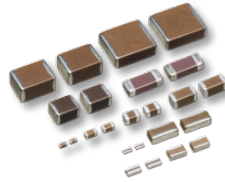

Commercial Grade
C Series

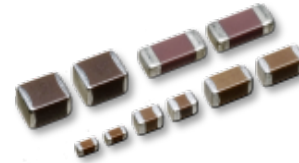

Automotive Grade
CGA Series

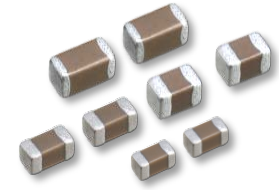

High Reliability Grade
CGJ Series

Data Requirements	Certificate of Compliance	-	-	Each Lot (Web)
	Electrical Test Report	-	-	Each Lot (Web)
	Qualification	-	PPAP	PPAP+
	Life Estimation	-	FIT & MTTF (PPAP)	FIT & MTTF (web)
	Re-validation	-	-	Annually
Manufacturing Requirements	TQS-9000 (internal qualification)	●	●	●
	ISO-9001 Certification	●	●	●
	ISO-14001 Certification	●	●	●
	TS-16949 Certification	-	●	●
	Product Maturity	0 Months	6 Months or greater	12 Months or greater
Customer Support	3 / 3 / 7 Failure Analysis Policy	●	●	●
	Failure Analysis Priority	FIFO	FIFO	RUSH
Typical Price Premium *		1x	1.5x	2x

*Typical premium are for standard values.

CGJ series | High Reliability Series - Cap Range -

Cap Range:

- ❖ Reliability tests based on MIL-STD requirements
- ❖ Qualified to AEC-Q200
- ❖ Manufactured using matured process for guaranteed performance
- ❖ 0402 ~ 1206 / COG, X7R
- ❖ 6.3V ~ 50V / up to 10uF

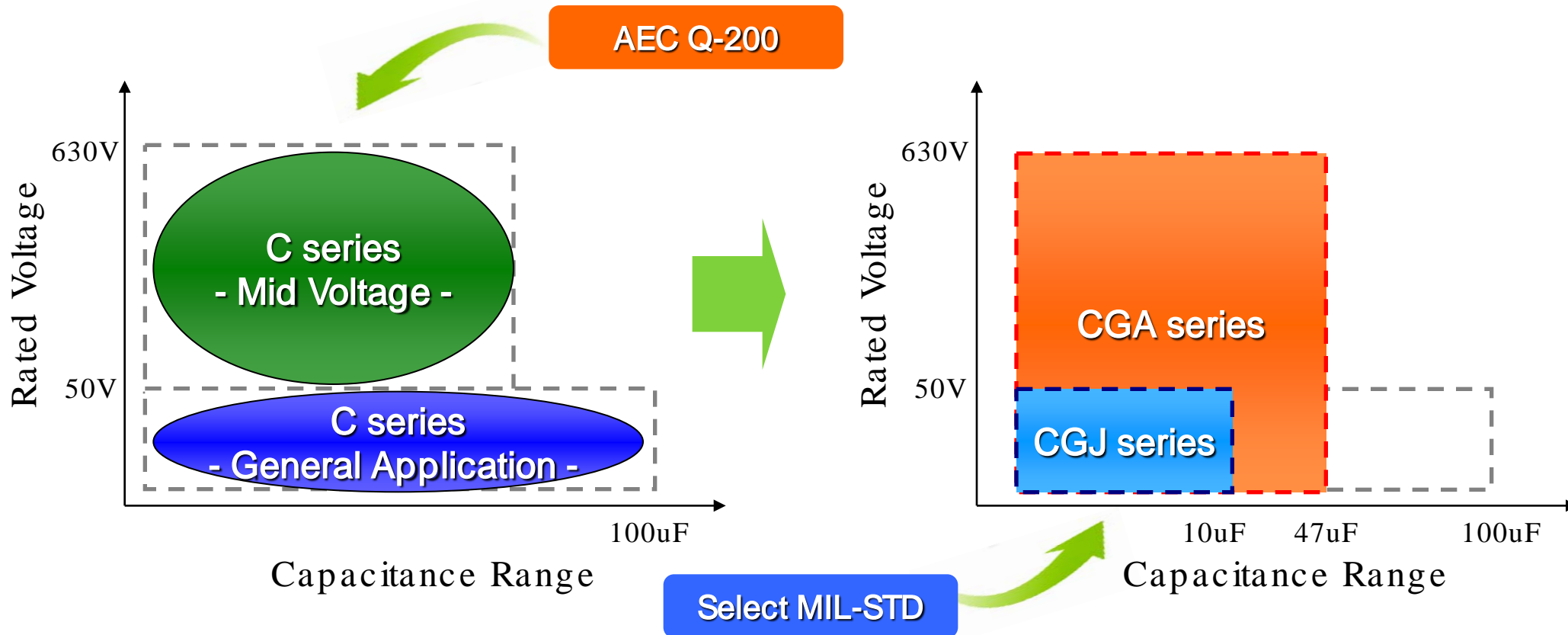

CGJ series | High Reliability Series- Features -

Features:

CGJ series

AEC Q-200

Select MIL-STD



Anti-Counterfeit

The seal to assist in the identification of authentic TDK CGJ products. The condition of the seal also indicates if the product has been tampered with in the supply chain

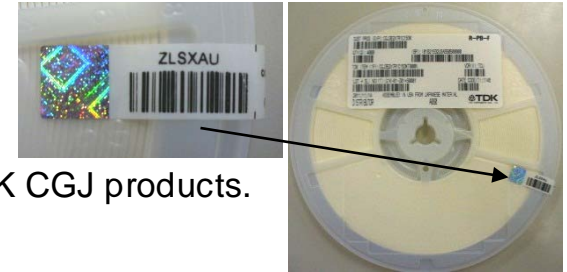

Certificate of Compliance

Documentation is provided for each CGJ lot online: <http://www.tdk.com/product-validation.php>



RFID Label

RFID Label to allow integration with inventory management programs

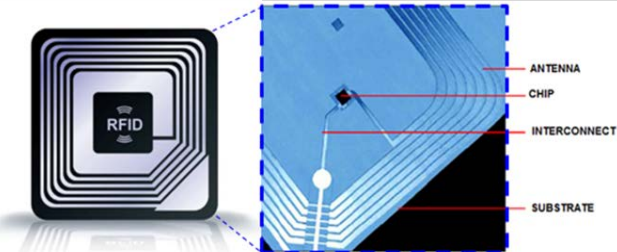

Premium Level Service

Customer priority backed by local US factory. TDK offers the highest level of customer service for claims, technical data and inventory needs for CGJ Series products.

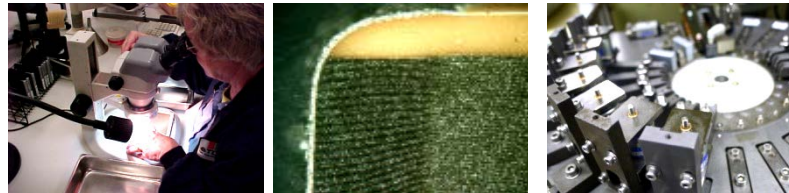

Increased Evaluation

To promote extended life

CGJ series | High Reliability Series- Applications -

Decoupling

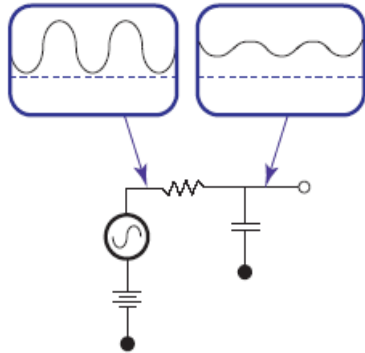

Reduces AC ripple voltage.

Filtering

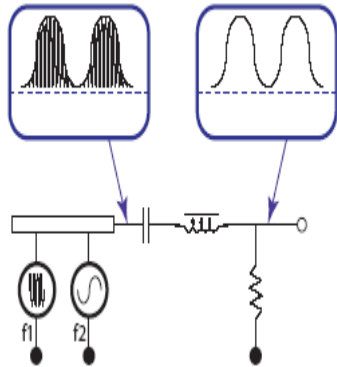

Removes unwanted frequency signals. In this example, f1 is removed.

Bypassing/Smoothing

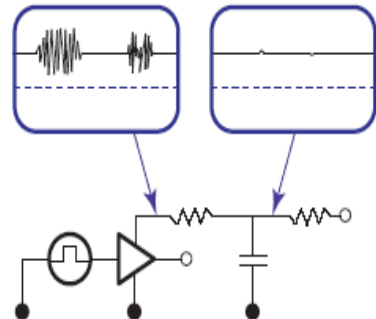

"Absorbs" DC voltage spikes.



High Reliability Guaranteed Applications



Smart Meter / Smart Grid



Electric Vehicle Charging Station



Telecom Base Station



Solar Micro Inverter



CGJ Series

LED Lighting



Military Communication Equipment



Class 1 & 2 Medical Equipment





CGJ series | High Reliability Series- Design Tools/Resources -

TVCL – TDK Virtual Component Library

<http://www.tdk.com/tvcl.php>

CCV – Components Characteristics Viewer

<http://www.tdk.co.jp/ccv/index.asp>

SEAT – Selection Assistant of TDK Components

<http://www.tdk.com/seat.php>

MLCC Sample Kits

<http://www.mouser.com/Search/Refine.aspx?Ne=254016&N=1323038+4232846+4294963871>

CGJ series I High Reliability Series- Part Number Description -

(1)
(2)
(3)
(4)
(5)
(6)
(7)

CGJ5 L 2 X7R 1A 106 K

(1) Series/Dimension Code					
Series	Code	EIA	L (mm)	W (mm)	T (mm) Nominal
CGJ – Extended Life	2	0402	1.00	0.50	0.50
	3	0603	1.60	0.80	0.80
	4	0805	2.00	1.20	1.25
	5	1206	3.20 x 1.60		1.60

(2) Nominal Thickness Code T(mm)			
Symbol	Thickness	Symbol	Thickness
B	0.50 mm	H	1.15 mm
C	0.60 mm	J	1.25 mm
E	0.80 mm	L	1.60 mm
F	0.85 mm		

(3) Voltage Condition for Life Test			
Code	Condition	Code	Condition
1	1 x R.V.	3	1.5 x R.V.
2	2 x R.V.	4	1.2 x R.V.

(4) Temperature Characteristics		
Temperature Characteristics	Temperature Range	Capacitance Change
C0G	-55 ~ 125°C	0 30 ppm/°C
X7R	-55 ~ 125°C	15%

(5) Rated Voltage Code (Vdc)	
Symbol	Rated Voltage (V _{DC})
0J	6.3
1A	10
1C	16
1E	25
1H	50

(6) Nominal Capacitance (pF)			
Symbol	Cap Value (pF)	Cap Value (nF)	Cap Value (μF)
101	100 pF	0.1 nF	0.0001 μF
102	1,000pF	1 nF	0.001 μF
105	1,000,000 pF	1,000 nF	1 μF
106	10,000,000 pF	10,000 nF	10 μF

(7) Capacitance Tolerance Code	
Symbol	Capacitance Tolerance
J	5%
K	10%

The capacitance is expressed in three digit codes and in units of pico Farads (pF). The first and second digits identify the first and second significant figures of the capacitance. The third digit identifies the multiplier. R designates a decimal point.

CGJ series | High Reliability Series- Summary -

Summary:

- ❖ TDK's CGJ series is the highest reliability multilayer ceramic capacitor offered by TDK through increased evaluation in the manufacturing process
- ❖ The CGJ series offers additional benefits such as: Tamper Proof Seal, RFID Label, Certificate of Compliance, and Premium Level Service
- ❖ TDK has design tools to help support optimal MLCC component selection



Why TDK:

- ❖ World Class Supplier
- ❖ ppb Quality
- ❖ Local Factory Support
- ❖ Zero restrictive or banned materials

