



BOURNS®

Features

- High resistance to heat and humidity
- Resistance to mechanical shock and pressure
- Accurate dimensions for automatic surface mounting
- Wide inductance range (1.0nH to 1000uH)

Applications

- Mobil phones
- Cellular phones
- CTV, VCR, HIC, FDD

CM45, CM32, CM25, CM20, CM16, CM10 SMT Chip Inductors

General Specifications

Temperature Rise.....20°C max.
Ambient Temperature 80°C max.
Operating Temperature-20°C to +100°C
Storage Temperature-40°C to +100°C
Resistance to Soldering Heat260°C, 5 seconds

Materials

Core Material	
CM10, CM16.....Alumina Ceramic
CM20Polymer 3.9nH to 1000nH
CM25Polymer 10nH to 180nH
CM32Polymer 47nH to 180nH
Ferrite Core	
CM25220nH to 100uH
CM32220nH +
CM45All
Coil Type	
CM10, CM16Copper plating
CM20, CM25, CM32, CM45Copper wire
Enclosure	
CM10, CM16Resin
CM20, CM25, CM32, CM45Epoxy resin

Product Dimensions

CM100505, CM160808

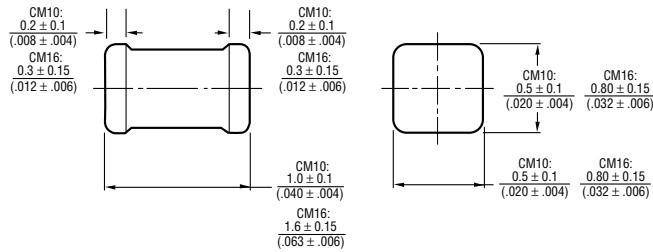

CM201212

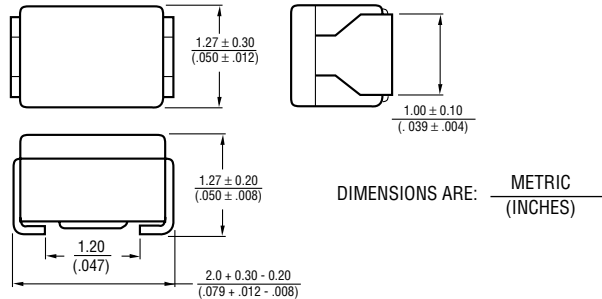

CM252016

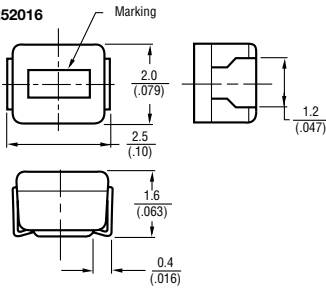

CM322522

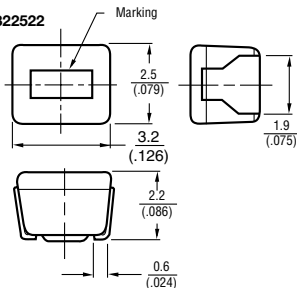

CM453232

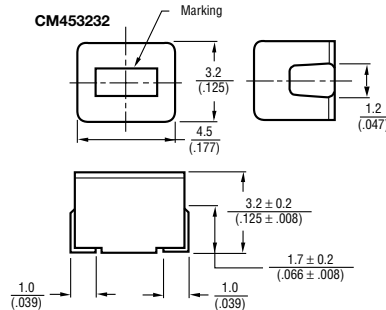

Recommended Land Pattern Dimensions

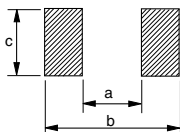

Model	a	b	c
CM10	0.5 to 0.6 (.019 to .023)	1.5 to 1.7 (.059 to .067)	0.5 to 0.6 (.019 to .023)
CM16	0.8 to 1.0 (.032 to .039)	2.0 to 2.6 (.079 to .102)	0.7 to 0.9 (.028 to .035)
CM20	1.0 to 1.2 (.039 to .047)	3.0 to 3.8 (.118 to .150)	0.9 to 1.3 (.028 to .051)
CM25	1.4 to 1.5 (.055 to .059)	3.5 to 4.0 (.138 to .157)	1.2 to 1.6 (.047 to .063)
CM32	1.6 to 2.0 (.063 to .079)	4.0 to 4.6 (.157 to .181)	1.9 to 2.4 (.075 to .094)
CM45	2.4 to 2.6 (.094 to .102)	5.5 to 6.0 (.217 to .236)	2.0 to 3.0 (.079 to .118)

CM45, CM32, CM25, CM20, CM16, CM10 SMT Chip Inductors



Packaging Specifications

CM10, CM16, CM20, CM25, CM32

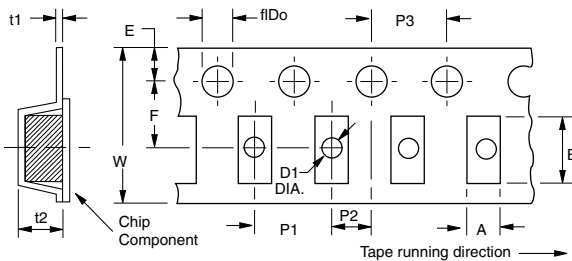

CM45

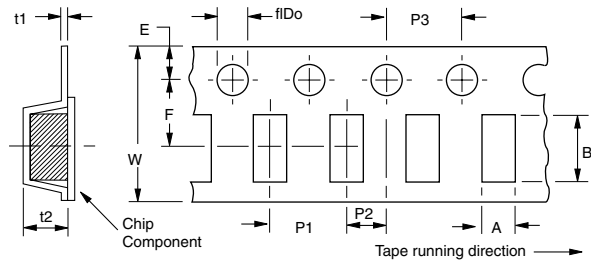

Model	A	B	W	F	E	P1	P2	P3	øD0	øD1	t1	t2
CM10	0.71 (.027)	1.21 (.047)	8.00 (.315)	3.50 (.138)	1.75 (.069)	4.00 (.157)	2.00 (.079)	4.00 (.157)	1.50 (.059)	0.60 (.024)	0.27 (.011)	1.20 (.047)
CM16	1.00 (.039)	1.80 (.071)	8.00 (.315)	3.50 (.138)	1.75 (.069)	4.00 (.157)	2.00 (.079)	4.00 (.157)	1.50 (.059)	0.60 (.024)	0.27 (.011)	1.20 (.047)
CM20	1.45 (.057)	2.25 (.089)	8.00 (.315)	3.50 (.138)	1.75 (.069)	4.00 (.157)	2.00 (.079)	4.00 (.157)	1.50 (.059)	1.00 (.039)	0.25 (.010)	1.55 (.061)
CM25	2.40 (.094)	2.90 (.114)	8.00 (.315)	3.50 (.138)	1.75 (.069)	4.00 (.157)	2.00 (.079)	4.00 (.157)	1.50 (.059)	1.10 (.043)	0.25 (.010)	1.85 (.073)
CM32	2.80 (.110)	3.60 (.142)	8.00 (.315)	3.50 (.138)	1.75 (.069)	4.00 (.157)	2.00 (.079)	4.00 (.157)	1.50 (.059)	—	0.25 (.010)	2.40 (.094)
CM45	3.60 (.142)	4.90 (.193)	12.00 (.472)	5.50 (.217)	1.75 (.069)	8.00 (.315)	2.00 (.079)	4.00 (.157)	1.50 (.059)	—	0.30 (.012)	3.50 (.138)

Reel Dimensions

Model	A	B	C	D	E	W
CM10	178 (7.008)	60 min.	13 (.512)	21 (.827)	2 (.079)	9 (.354)
CM16	178 (7.008)	60 min.	13 (.512)	21 (.827)	2 (.079)	9 (.354)
CM20	178 (7.008)	60 min.	13 (.512)	21 (.827)	2 (.079)	9 (.354)
CM25	178 (7.008)	60 min.	13 (.512)	21 (.827)	2 (.079)	9 (.354)
CM32	178 (7.008)	60 min.	13 (.512)	21 (.827)	2 (.079)	9 (.354)
CM45	178 (7.008)	60 min.	13 (.512)	21 (.827)	2 (.079)	13 (.512)

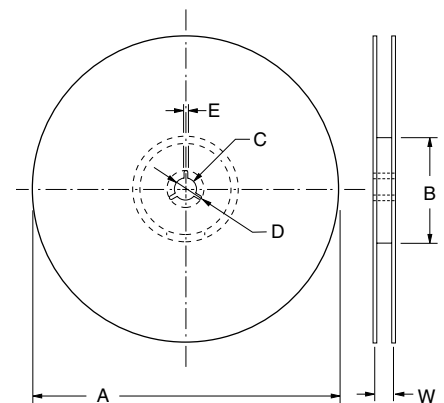

Packaging

Model	Quantity	Weight
CM10	10000 pcs	150g
CM16	3000 pcs	90g
CM20	3000 pcs	90g

Model	Quantity	Weight
CM25	2000 pcs	100g
CM32	2000 pcs	190g
CM45	500 pcs	100g

Soldering

Flow Soldering	260°C maximum for 5 seconds (2 wave solder method)
Infra-red	200°C for a maximum of 30 seconds. Peak of 240°C for a maximum of 5 seconds. If the solder does not reflow simultaneously under each terminal, there may be a misalignment of the component on the board. For this reason, it is recommended that the inductor be adhered to the board prior to reflow.
Vapor-phase	215°C for a maximum of 30 seconds.

Flow Soldering

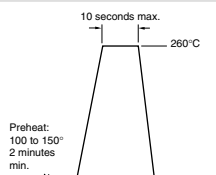

Infra-red Soldering

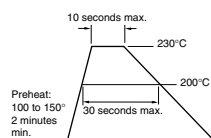

Vapor-phase Soldering

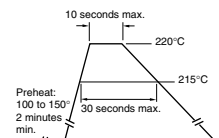

Specifications are subject to change without notice.

Chip Inductor - CM453232 Series Wirewound

BOURNS®

Part number	Inductance uH	Tolerance	Q min.	Test Frequency MHz	SRF min. MHz	RDC ohm max	IDC mA max
CM453232-R10M	0.10	±20%	35	25.2	300	0.18	800
CM453232-R12M	0.12	±20%	35	25.2	280	0.2	770
CM453232-R15M	0.15	±20%	35	25.2	250	0.22	730
CM453232-R18M	0.18	±20%	35	25.2	220	0.24	700
CM453232-R22M	0.22	±20%	40	25.2	200	0.25	665
CM453232-R27M	0.27	±20%	40	25.2	180	0.26	635
CM453232-R33M	0.33	±20%	40	25.2	165	0.28	605
CM453232-R39M	0.39	±20%	40	25.2	150	0.30	575
CM453232-R47M	0.47	±20%	40	25.2	145	0.32	545
CM453232-R56M	0.56	±20%	40	25.2	140	0.36	520
CM453232-R68M	0.68	±20%	40	25.2	135	0.40	500
CM453232-R82M	0.82	±20%	40	25.2	130	0.45	475
CM453232-1R0K	1.0	±10%	50	7.96	100	0.50	450
CM453232-1R2K	1.2	±10%	50	7.96	80	0.55	430
CM453232-1R5K	1.5	±10%	50	7.96	70	0.60	410
CM453232-1R8K	1.8	±10%	50	7.96	60	0.65	390
CM453232-2R2K	2.2	±10%	50	7.96	55	0.70	380
CM453232-2R7K	2.7	±10%	50	7.96	50	0.75	370
CM453232-3R3K	3.3	±10%	50	7.96	45	0.80	355
CM453232-3R9K	3.9	±10%	50	7.96	40	0.90	330
CM453232-4R7K	4.7	±10%	50	7.96	35	1.00	315
CM453232-5R6K	5.6	±10%	50	7.96	33	1.10	300
CM453232-6R8K	6.8	±10%	50	7.96	27	1.2	285
CM453232-8R2K	8.2	±10%	50	7.96	25	1.4	270
CM453232-100K	10	±10%	50	2.52	20	1.6	250
CM453232-120K	12	±10%	50	2.52	18	2	225
CM453232-150K	15	±10%	50	2.52	17	2.5	200
CM453232-180K	18	±10%	50	2.52	15	2.8	190
CM453232-220K	22	±10%	50	2.52	13	3.2	180
CM453232-270K	27	±10%	50	2.52	12	3.6	170
CM453232-330K	33	±10%	50	2.52	11	4	160
CM453232-390K	39	±10%	50	2.52	10	4.5	150
CM453232-470K	47	±10%	50	2.52	10	5	140
CM453232-560K	56	±10%	50	2.52	9	5.5	135
CM453232-680K	68	±10%	50	2.52	9	6	130
CM453232-820K	82	±10%	50	2.52	8	7	120
CM453232-101K	100	±10%	40	2.52	8	8	110
CM453232-121K	120	±10%	40	0.796	6	8	110
CM453232-151K	150	±10%	40	0.796	5	9	105
CM453232-181K	180	±10%	40	0.796	5	9.5	102
CM453232-221K	220	±10%	40	0.796	4	10	100
CM453232-271K	270	±10%	40	0.796	4	12	92
CM453232-331K	330	±10%	40	0.796	3.5	14	85
CM453232-391K	390	±10%	40	0.796	3	18	80
CM453232-471K	470	±10%	40	0.796	3	26	62
CM453232-561K	560	±10%	30	0.796	3	30	50
CM453232-681K	680	±10%	30	0.796	3	30	50
CM453232-821K	820	±10%	30	0.796	2.5	35	30
CM453232-102K	1000	±10%	30	0.252	2.5	40	30

TIGHTER TOLERANCE AVAILABLE ON REQUEST. CONSULT FACTORY.

Specifications are subject to change without notice.

Chip Inductor - CM322522 Series Wirewound

Part number	Inductance uH	Tolerance	Q min.	Test Frequency MHz	SRF min. MHz	RDC ohm max	IDC mA max
CM322522-47NM	0.047	±20%	10	100	680	0.20	450
CM322522-56NM	0.056	±20%	10	100	600	0.22	420
CM322522-68NM	0.068	±20%	10	100	540	0.25	400
CM322522-82NM	0.082	±20%	10	100	500	0.27	380
CM322522-R10M	0.10	±20%	10	100	450	0.30	360
CM322522-R12M	0.12	±20%	10	25.2	400	0.67	240
CM322522-R15M	0.15	±20%	10	25.2	350	0.72	230
CM322522-R18M	0.18	±20%	10	25.2	320	0.81	220
CM322522-R22M	0.22	±20%	25	25.2	230	0.29	360
CM322522-R27M	0.27	±20%	25	25.2	210	0.32	345
CM322522-R33M	0.33	±20%	25	25.2	190	0.35	330
CM322522-R39M	0.39	±20%	25	25.2	175	0.39	305
CM322522-R47M	0.47	±20%	25	25.2	160	0.44	290
CM322522-R56M	0.56	±20%	25	25.2	150	0.49	275
CM322522-R68M	0.68	±20%	25	25.2	135	0.55	260
CM322522-R82M	0.82	±20%	25	25.2	125	0.61	245
CM322522-1R0K	1.0	±10%	30	7.96	115	0.69	230
CM322522-1R2K	1.2	±10%	30	7.96	100	0.75	215
CM322522-1R5K	1.5	±10%	30	7.96	90	0.75	210
CM322522-1R8K	1.8	±10%	30	7.96	85	0.82	200
CM322522-2R2K	2.2	±10%	30	7.96	80	0.95	190
CM322522-2R7K	2.7	±10%	30	7.96	75	1.1	180
CM322522-3R3K	3.3	±10%	30	7.96	65	1.2	180
CM322522-3R9K	3.9	±10%	30	7.96	60	1.3	175
CM322522-4R7K	4.7	±10%	30	7.96	55	1.5	165
CM322522-5R6K	5.6	±10%	30	7.96	50	1.6	160
CM322522-6R8K	6.8	±10%	30	7.96	45	1.8	150
CM322522-8R2K	8.2	±10%	30	7.96	40	2.0	140
CM322522-100K	10	±10%	30	2.52	36	2.1	140
CM322522-120K	12	±10%	30	2.52	33	2.5	125
CM322522-150K	15	±10%	30	2.52	30	2.8	120
CM322522-180K	18	±10%	30	2.52	27	3.3	110
CM322522-220K	22	±10%	30	2.52	25	3.7	105
CM322522-270K	27	±10%	30	2.52	22	5.0	90
CM322522-330K	33	±10%	30	2.52	20	5.6	85
CM322522-390K	39	±10%	30	2.52	20	6.4	80
CM322522-470K	47	±10%	30	2.52	15	7.0	75
CM322522-560K	56	±10%	30	2.52	15	8.0	70
CM322522-680K	68	±10%	30	2.52	15	9.0	65
CM322522-820K	82	±10%	30	2.52	11	10	60
CM322522-101K	100	±10%	20	0.796	10	10	60
CM322522-121K	120	±10%	20	0.796	10	11	55
CM322522-151K	150	±10%	20	0.796	8	15	50
CM322522-181K	180	±10%	20	0.796	7	17	50
CM322522-221K	220	±10%	20	0.796	7	21	45

TIGHTER TOLERANCE AVAILABLE ON REQUEST. CONSULT FACTORY.

COMMENT: 47nH TO 180nH 'AIR CORE' / 220nH TO 220uH 'FERRITE CORE'

Chip Inductor - CM252016 Series Wirewound



Part number	Inductance uH	Tolerance	Q min.	Test Frequency MHz	SRF min. MHz	RDC ohm max	IDC mA max
CM252016-10NK	0.010	±10%	10	100	2500	0.32	280
CM252016-12NK	0.012	±10%	10	100	2200	0.34	270
CM252016-15NK	0.015	±10%	10	100	1800	0.38	255
CM252016-18NK	0.018	±10%	10	100	1550	0.4	250
CM252016-22NK	0.022	±10%	15	100	1350	0.43	240
CM252016-27NK	0.027	±10%	15	100	1150	0.47	230
CM252016-33NK	0.033	±10%	15	100	1000	0.51	220
CM252016-39NK	0.039	±10%	15	100	890	0.55	215
CM252016-47NK	0.047	±10%	15	100	770	0.59	205
CM252016-56NK	0.056	±10%	15	100	670	0.63	200
CM252016-68NK	0.068	±10%	15	100	590	0.68	190
CM252016-82NK	0.082	±10%	15	100	520	0.73	185
CM252016-R10K	0.10	±10%	10	25.2	460	0.80	175
CM252016-R12K	0.12	±10%	10	25.2	400	0.87	170
CM252016-R15K	0.15	±10%	10	25.2	340	0.98	160
CM252016-R18K	0.18	±10%	10	25.2	300	1.05	155
CM252016-R22M	0.22	±20%	25	25.2	230	0.70	190
CM252016-R27M	0.27	±20%	25	25.2	210	0.75	180
CM252016-R33M	0.33	±20%	25	25.2	190	0.85	170
CM252016-R39M	0.39	±20%	25	25.2	175	0.95	160
CM252016-R47M	0.47	±20%	25	25.2	160	1.00	155
CM252016-R56M	0.56	±20%	25	25.2	150	1.10	150
CM252016-R68M	0.68	±20%	25	25.2	135	1.25	140
CM252016-R82M	0.82	±20%	25	25.2	125	1.40	130
CM252016-1R0K	1.0	±10%	25	7.96	115	0.65	195
CM252016-1R2K	1.2	±10%	25	7.96	100	0.75	180
CM252016-1R5K	1.5	±10%	25	7.96	90	0.85	170
CM252016-1R8K	1.8	±10%	25	7.96	85	0.95	160
CM252016-2R2K	2.2	±10%	25	7.96	80	1.05	155
CM252016-2R7K	2.7	±10%	25	7.96	75	1.2	145
CM252016-3R3K	3.3	±10%	25	7.96	65	1.3	135
CM252016-3R9K	3.9	±10%	25	7.96	60	1.4	130
CM252016-4R7K	4.7	±10%	25	7.96	55	1.6	125
CM252016-5R6K	5.6	±10%	25	7.96	50	1.8	120
CM252016-6R8K	6.8	±10%	25	7.96	45	1.9	115
CM252016-8R2K	8.2	±10%	25	7.96	40	2.2	105
CM252016-100K	10	±10%	25	2.52	32	3.5	80
CM252016-120K	12	±10%	25	2.52	30	3.8	75
CM252016-150K	15	±10%	25	2.52	28	4.4	70
CM252016-180K	18	±10%	25	2.52	25	5.0	65
CM252016-220K	22	±10%	25	2.52	22	5.8	60
CM252016-270K	27	±10%	20	2.52	21	6.3	115
CM252016-330K	33	±10%	20	2.52	20	7.1	110
CM252016-390K	39	±10%	20	2.52	18	9.5	90
CM252016-470K	47	±10%	20	2.52	17	11.0	80
CM252016-560K	56	±10%	20	2.52	16	12.1	75
CM252016-680K	68	±10%	20	2.52	15	16.6	70
CM252016-820K	82	±10%	20	2.52	13	19.0	65
CM252016-101K	100	±10%	15	0.796	12	21.0	60

TIGHTER TOLERANCE AVAILABLE ON REQUEST. CONSULT FACTORY.

COMMENT: 10nH TO 180nH 'AIR CORE' / 220nH TO 220uH 'FERRITE CORE'

Specifications are subject to change without notice.

Chip Inductor - CM201212 Series Wirewound

BOURNS®

Part number	Inductance uH	Tolerance	Q min.	Test Frequency MHz	SRF min. MHz	RDC ohm max	IDC mA max
CM201212-3N9M	0.0039	±20%	6	100	6000	0.1	540
CM201212-4N7M	0.0074	±20%	6	100	6000	0.1	540
CM201212-5N6M	0.0056	±20%	6	100	5000	0.12	540
CM201212-6N8M	0.0068	±20%	8	100	5000	0.15	540
CM201212-8N2M	0.0082	±20%	8	100	5000	0.16	540
CM201212-10NK	0.010	±10%	10	100	3300	0.20	540
CM201212-12NK	0.012	±10%	10	100	3300	0.23	535
CM201212-15NK	0.015	±10%	12	100	3000	0.25	520
CM201212-18NK	0.018	±10%	12	100	3000	0.27	480
CM201212-22NK	0.022	±10%	15	100	2600	0.29	465
CM201212-27NK	0.027	±10%	15	100	2500	0.32	455
CM201212-33NK	0.033	±10%	15	100	2000	0.37	395
CM201212-39NK	0.039	±10%	15	100	2000	0.38	390
CM201212-47NK	0.047	±10%	15	100	1600	0.42	385
CM201212-56NK	0.056	±10%	15	100	1500	0.45	360
CM201212-68NK	0.068	±10%	15	100	1400	0.52	340
CM201212-82NK	0.082	±10%	15	100	1100	0.60	330
CM201212-R10K	0.10	±10%	8	25.2	800	0.78	285
CM201212-R12K	0.12	±10%	8	25.2	600	0.99	275
CM201212-R15K	0.15	±10%	10	25.2	600	1.47	230
CM201212-R18K	0.18	±10%	10	25.2	600	1.61	195
CM201212-R22K	0.22	±10%	10	25.2	500	1.84	170
CM201212-R27K	0.27	±10%	10	25.2	300	1.95	165
CM201212-R33K	0.33	±10%	10	25.2	200	2.16	160
CM201212-R39K	0.39	±10%	10	25.2	150	2.35	150
CM201212-R47K	0.47	±10%	10	25.2	150	2.57	145
CM201212-R56K	0.56	±10%	10	25.2	100	2.65	140
CM201212-R68K	0.68	±10%	10	25.2	100	2.99	130
CM201212-R82K	0.82	±10%	10	25.2	80	3.35	125
CM201212-1R0K	1.0	±10%	8	7.96	80	3.82	120

TIGHTER TOLERANCE AVAILABLE ON REQUEST. CONSULT FACTORY.

Chip Inductor - CM160808, CM100505 Series Laser-cut Winding
BOURNS®

Part number	Inductance nH	Tolerance	Q min.	Test Frequency MHz	SRF min. MHz	RDC ohm max	IDC mA max
CM160808-1N5D	1.5	± 0.3nH	8	100	6000	0.07	500
CM160808-1N8D	1.8	± 0.3nH	8	100	6000	0.08	500
CM160808-2N2D	2.2	± 0.3nH	8	100	6000	0.09	500
CM160808-2N7D	2.7	± 0.3nH	8	100	6000	0.10	500
CM160808-3N3D	3.3	± 0.3nH	9	100	5500	0.12	500
CM160808-3N9J	3.9	±5%	9	100	5500	0.15	450
CM160808-4N7J	4.7	±5%	9	100	4800	0.17	450
CM160808-5N6J	5.6	±5%	9	100	4600	0.18	430
CM160808-6N8J	6.8	±5%	9	100	3550	0.20	430
CM160808-8N2J	8.2	±5%	9	100	3500	0.28	400
CM160808-10NJ	10	±5%	10	100	2800	0.32	400
CM160808-12NJ	12	±5%	10	100	2800	0.35	400
CM160808-15NJ	15	±5%	10	100	2500	0.41	350
CM160808-18NJ	18	±5%	10	100	2300	0.45	350
CM160808-22NJ	22	±5%	10	100	2000	0.50	300
CM160808-27NJ	27	±5%	10	100	2000	0.55	300
CM160808-33NJ	33	±5%	10	100	1800	0.60	300
CM160808-39NJ	39	±5%	11	100	1800	0.80	300
CM160808-47NJ	47	±5%	11	100	1800	0.95	250
CM160808-56NJ	56	±5%	12	100	1800	1.2	250
CM160808-68NJ	68	±5%	12	100	1500	1.3	250
CM160808-82NJ	82	±5%	12	100	1500	1.5	250
CM160808-R10J	100	±5%	12	100	1300	1.8	200

Part number	Inductance nH	Tolerance	Q min.	Test Frequency MHz	SRF min. MHz	RDC ohm max	IDC mA max
CM100505-1N0D	1.00	±0.3nH	8	100	6000	0.05	400
CM100505-1N2D	1.20	±0.3nH	8	100	6000	0.06	400
CM100505-1N5D	1.50	±0.3nH	8	100	6000	0.07	400
CM100505-1N8D	1.80	±0.3nH	8	100	6000	0.08	400
CM100505-2N2D	2.20	±0.3nH	8	100	6000	0.09	400
CM100505-2N7D	2.70	±0.3nH	8	100	5500	0.10	400
CM100505-3N3D	3.30	±0.3nH	8	100	5500	0.12	400
CM100505-3N9D	3.90	±0.3nH	8	100	5200	0.15	360
CM100505-4N7D	4.70	±0.3nH	8	100	4800	0.17	360
CM100505-5N6D	5.60	±0.3nH	8	100	4600	0.19	340
CM100505-6N8J	6.80	± 5%	8	100	4000	0.30	320
CM100505-8N2J	8.20	± 5%	8	100	3500	0.35	320
CM100505-10NJ	10.00	± 5%	8	100	2800	0.41	320
CM100505-12NJ	12.00	± 5%	8	100	2800	0.45	320
CM100505-15NJ	15.00	± 5%	8	100	2500	0.60	240
CM100505-18NJ	18.00	± 5%	8	100	2200	0.70	240
CM100505-22NJ	22.00	± 5%	8	100	2000	0.80	200
CM100505-27NJ	27.00	± 5%	8	100	1800	1.2	200
CM100505-33NJ	33.00	± 5%	8	100	1800	1.4	170
CM100505-39NJ	39.00	± 5%	8	100	1800	1.7	150
CM100505-47NJ	47.00	± 5%	8	100	1800	2.1	140