

Thick Film Resistor Array

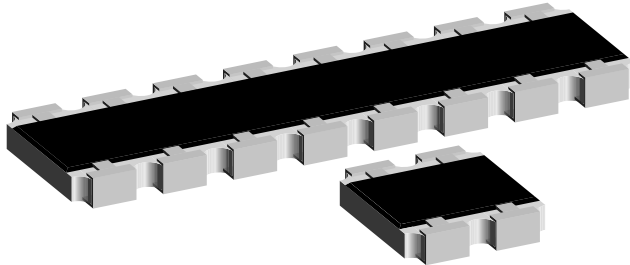

FEATURES

- Convex terminal array available with either scalloped corners (E version) or square corners (S version)
- Wide ohmic range: 10R to 1M Ω
- 4, 8, 10 or 16 terminal package with isolated resistors
- Lead (Pb)-free solder contacts on Ni barrier layer
- Pure tin plating provides compatibility with lead (Pb)-free and lead containing soldering processes
- Compatible with "Restriction of the use of Hazardous Substances" (RoHS) directive 2002/95/EC (issue 2004)



STANDARD ELECTRICAL SPECIFICATIONS							
MODEL	CIRCUIT	POWER RATING $P_{70\text{ }^\circ\text{C}}$ W	LIMITING ELEMENT VOLTAGE MAX. V_{\equiv}	TEMPERATURE COEFFICIENT ppm/K	TOLERANCE %	RESISTANCE RANGE Ω	E-SERIES
CRA12E CRA12S	01; 02; 20	0.100	50	± 100	± 1	10R - 1M Ω	24 + 96
	03	0.125		± 200	$\pm 2; \pm 5$		24
Zero-Ohm-Resistor: $R_{\text{max.}} = 50 \text{ m}\Omega$, $I_{\text{max.}} = 1.5 \text{ A}$							

TECHNICAL SPECIFICATIONS			
PARAMETER	UNIT	CRA12E & S - 01/02/20 CIRCUIT	CRA12E & S - 03 CIRCUIT
Rated Dissipation at 70 °C ⁽²⁾	W per element	0.1	0.125
Limiting Element Voltage ⁽¹⁾	V_{\equiv}	50	
Insulation Voltage (1 min)	$V_{\text{dc/ac peak}}$	100	
Category Temperature Range	°C	- 55 to + 155	
Insulation Resistance	Ω	$> 10^9$	

Notes

⁽¹⁾ Rated voltage: $\sqrt{P \times R}$

⁽²⁾ The power dissipation on the resistor generates a temperature rise against the local ambient, depending on the heat flow support of the printed-circuit board (thermal resistance). The rated dissipation applies only if permitted film temperature of 155 °C is not exceeded.

PART NUMBER AND PRODUCT DESCRIPTION							
PART NUMBER: CRA12E08347K0JTR							
C	R	A	1	2	E	0	8
			3	4	7	K	0
						J	T
							R
MODEL	TERMINAL STYLE	PIN	CIRCUIT	VALUE	TOLERANCE	PACKAGING ⁽⁴⁾	SPECIAL
CRA12	S E	04 08 10 16	1 = 01 2 = 02 3 = 03 8 = 20	R = Decimal K = Thousand M = Million 0000 = 0 Ω Jumper	F = $\pm 1\%$ G = $\pm 2\%$ J = $\pm 5\%$ Z = 0 Ω Jumper	TR TL	Up to 2 digits
PRODUCT DESCRIPTION: CRA12S 08 03 473 J RB8 e3							
CRA12S	08	03	473	J	RB8	e3	
MODEL	TERMINAL COUNT	CIRCUIT TYPE	RESISTANCE VALUE	TOLERANCE	PACKAGING ⁽⁴⁾	LEAD (Pb)-FREE	
CRA12E CRA12S	04 08 10 16	01 02 03 20	473 = 47 k Ω 4702 = 47 k Ω 10R0 = 10 Ω 100 = 10 Ω 000 = 0 Ω Jumper First two digits (three for 1 %) are significant. Last digit is the multiplier	F = $\pm 1\%$ G = $\pm 2\%$ J = $\pm 5\%$ Z = 0 Ω Jumper	RB8 RD7	e3 = Pure tin Termination finish	

Notes

⁽³⁾ Preferred way for ordering products is by use of the PART NUMBER

⁽⁴⁾ Please refer to table PACKAGING, see next page

AVAILABLE TYPES AND RANGES				
MODEL	TERMINAL COUNT	CIRCUIT	TEMPERATURE COEFFICIENT	TOLERANCE
CRA12 S	08	03	± 100 ppm/K ± 200 ppm/K	± 1 % ± 5 %; ± 2 %
	10	01		
		02		
		03		
CRA12 E	04	01		
		03		
	08	01		
	10	02		
16	03			
	20			

PACKAGING						
MODEL	TAPE WIDTH	DIAMETER	PITCH	PIECES/REEL	PACKAGING CODE	
					BLISTER TAPE	
					PART NUMBER	PRODUCT DESCRIPTION
CRA12 E 04	8 mm	180 mm/7"	4 mm	2000	TR	RB8
CRA12 E 08 CRA12 S 08 CRA12 E 10 CRA12 S 10	12 mm	180 mm/7" 330 mm/13"	8 mm	2000 5000	TR TL	RB8 RD7
CRA12 E 16	24 mm	330 mm/13"	8 mm	2000 5000	TR TL	RB8 RD7

CIRCUIT

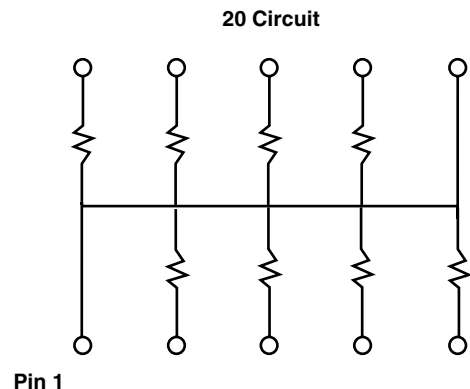
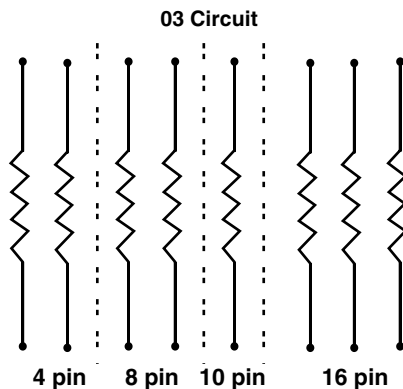
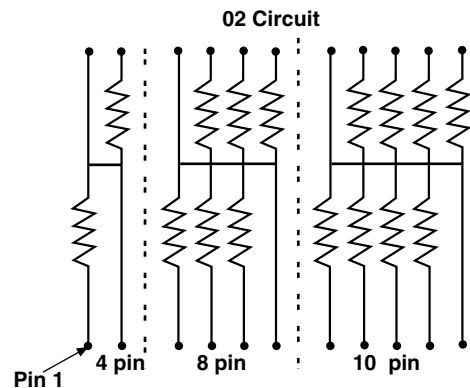
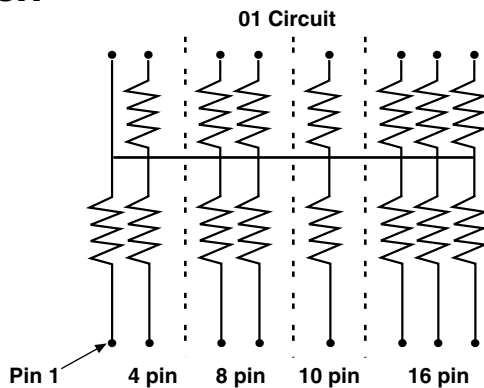

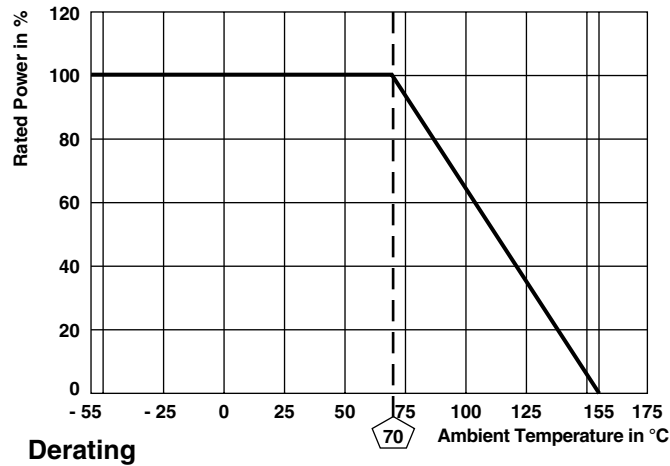

DIMENSIONS

8-Terminal device

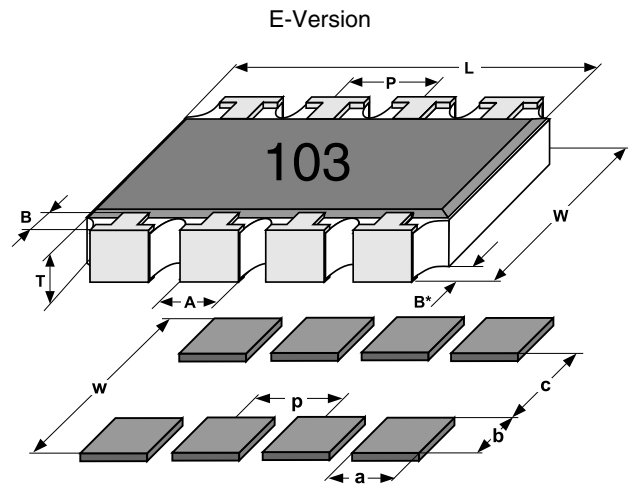
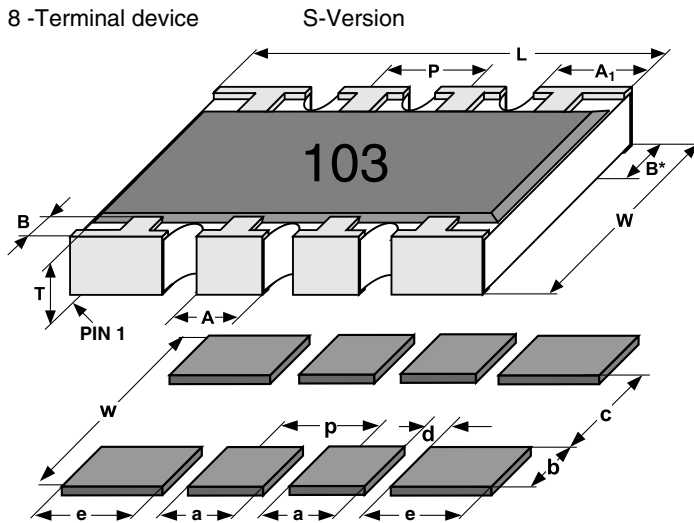

MODEL	PIN NO#	DIMENSIONS [in millimeters]							
		L	A	A*	B	B*	P	T	W
CRA12E	4	2.54	0.79	-	0.51	0.38	1.27	0.53	3.05
CRA12E	8	5.08	0.79	-	0.51	0.38	1.27	0.53	3.05
CRA12S	8	5.08	0.79	0.89	0.51	0.38	1.27	0.53	3.05
CRA12E	10	6.40	0.79	-	0.51	0.38	1.27	0.53	3.05
CRA12S	10	6.40	0.79	0.89	0.51	0.38	1.27	0.53	3.05
CRA12E	16	10.30	0.79	-	0.51	0.38	1.27	0.53	3.05
	TOL.	-0.15	-0.15	-0.15	-0.25	-0.2	-0.1	-0.1	-0.15

SOLDER PAD DIMENSIONS [in millimeters]							
	c	w	d	p	a	b	e
WAVE	2.2	4.3	0.57	1.27	0.71	1.05	1.09
REFLOW	2.2	3.9	0.57	1.27	0.71	0.86	1.09

The dimensions shown are for 8 pin part. For parts with different pin numbers use the same pitch and add or subtract pads as required.



TEST PROCEDURES AND REQUIREMENTS			
EN 60115-1			
TEST (clause)	CONDITIONS OF TEST	REQUIREMENTS (1)	
		STABILITY CLASS 1 OR BETTER	STABILITY CLASS 2 OR BETTER
	Stability for product types: CRA12E/CRA12S	10 Ω to 1 MΩ	10 Ω to 1 MΩ
Resistance (4.5)	-	± 1 %	± 2 %; ± 5 %
Temperature coefficient (4.8.4.2)	20/- 55/20 °C and 20/125/20 °C	± 100 ppm/K	± 200 ppm/K
Overload (4.13)	$U = 2.5 \times (P_{70} \times R)^{1/2}$ $\leq 2 \times U_{max.}; 1 \text{ s}$	± (0.25 % R + 0.05 Ω)	± (0.5 % R + 0.05 Ω)
Solderability (4.17.5) (2)	Aging 4 h at 155 °C, dryheat Solder bath method; 235 °C; 1 s Visual examination	Good tinning (≥ 95 % covered) no visible damage	
Resistance to soldering heat (4.18.2)	Solder bath method; (260 ± 5) °C; (10 ± 1) s	± (0.25 % R + 0.05 Ω)	± (0.5 % R + 0.05 Ω)
Rapid change of temperature (4.19)	30 min. at LCT = - 55 °C; 30 min. at UCT = 125 °C; 5 cycles	± (0.25 % R + 0.05 Ω)	± (0.5 % R + 0.05 Ω)
Damp heat, steady state (4.24)	(40 ± 2) °C; 56 days; (93 ± 3) % RH	± (1 % R + 0.05 Ω)	± (2 % R + 0.1 Ω)
Climatic sequence (4.23)	16 h at UCT = 125 °C; 1 cycle at 55 °C; 2 h at LCT = - 55 °C; 1 h/1 kPa at 15 °C to 35 °C; 5 cycles at 55 °C $U = (P_{70} \times R)^{1/2}$ $U = U_{max.};$ whichever is less severe	± (1 % R + 0.05 Ω)	± (2 % R + 0.1 Ω)
Endurance at 70 °C (4.25.1)	$U = (P_{70} \times R)^{1/2}$ $U = U_{max.};$ whichever is less severe 1.5 h ON; 0.5 h OFF; 70 °C; 1000 h	± (1 % R + 0.05 Ω)	± (2 % R + 0.1 Ω)
Extended endurance (4.25.1.8)	Duration extended to 8000 h	± (2 % R + 0.1 Ω)	± (4 % R + 0.1 Ω)
Endurance at upper category temperature (4.25.3)	UCT = 125 °C; 1000 h	± (1 % R + 0.05 Ω)	± (2 % R + 0.1 Ω)

Notes

(1) Figures are given for a single element

(2) Solderability is specified for 2 years after production or requalification. Permitted storage time is 20 years

APPLICABLE SPECIFICATIONS	
• EN 60115-1	Generic Specification
• EN 140400	Sectional Specification
• EN 140401-802	Detail Specification
• IEC 60068-2-X	Variety of environmental test procedures
• EIA 481	Packaging of SMD components



Disclaimer

All product specifications and data are subject to change without notice.

Vishay Intertechnology, Inc., its affiliates, agents, and employees, and all persons acting on its or their behalf (collectively, "Vishay"), disclaim any and all liability for any errors, inaccuracies or incompleteness contained herein or in any other disclosure relating to any product.

Vishay disclaims any and all liability arising out of the use or application of any product described herein or of any information provided herein to the maximum extent permitted by law. The product specifications do not expand or otherwise modify Vishay's terms and conditions of purchase, including but not limited to the warranty expressed therein, which apply to these products.

No license, express or implied, by estoppel or otherwise, to any intellectual property rights is granted by this document or by any conduct of Vishay.

The products shown herein are not designed for use in medical, life-saving, or life-sustaining applications unless otherwise expressly indicated. Customers using or selling Vishay products not expressly indicated for use in such applications do so entirely at their own risk and agree to fully indemnify Vishay for any damages arising or resulting from such use or sale. Please contact authorized Vishay personnel to obtain written terms and conditions regarding products designed for such applications.

Product names and markings noted herein may be trademarks of their respective owners.