

CTP4558 is a medium current inductor with the following data and features:

- **Core type:** 0.50" o.d., Moly-Permalloy Powder, perm 125.
  - **Power rating:** 0.50 watts for temp. rise 50°C.
  - **Typical applications:** Switching Inductors in Switch Mode Power Supplies.
- Four mounting styles are offered:**
- 1 Flying leads (1.00"), for vertical or horizontal mounting.
  - 2 4-pin header, for vertical mounting.
  - 3 Threaded center hole, flying leads (2.00").
  - 4 2-pin header, for vertical mounting.



### MECHANICAL

Style 1

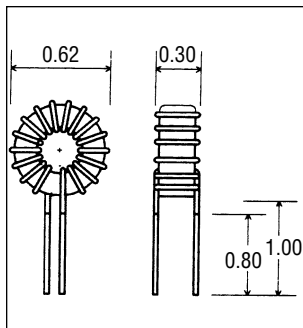

Style 2

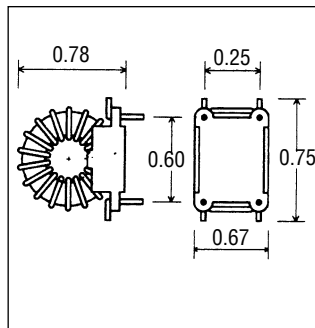

Style 3

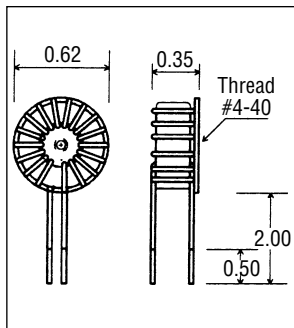

Style 4

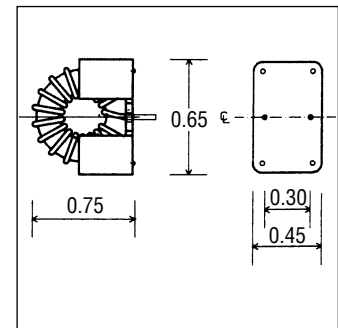

### ELECTRICAL SPECIFICATION

**Ordering Information:** Substitute the style number for the asterisk (\*). Example: CTP4558, Style 1, 56uH. Order: CTP4558 - 116

Part No. CTP4558 -	Inductance (uH)	DCR Ohms	Rated Current Amp. RMS	I (amp.) @ Lsat. 10%	I (amp.) @ Lsat. 25%	I (amp.) @ Lsat. 50%
* 01	3.3	0.005	9.8	6.5	9.7	16.2
* 02	3.9	0.006	9.4	6.0	8.9	14.9
* 03	4.7	0.006	9.0	5.4	8.1	13.6
* 04	5.6	0.007	8.7	5.0	7.4	12.4
* 05	6.8	0.009	7.4	4.5	6.8	11.3
* 06	8.2	0.010	7.1	4.1	6.2	10.3
* 07	10	0.011	6.7	3.7	5.6	9.3
* 08	12	0.012	6.4	3.4	5.1	8.5
* 09	15	0.013	6.1	3.0	4.6	7.6
* 10	18	0.015	5.9	2.8	4.2	6.9
* 11	22	0.016	5.6	2.5	3.8	6.3
* 12	27	0.018	5.3	2.3	3.4	5.7
* 13	33	0.019	5.1	2.0	3.1	5.1
* 14	39	0.021	4.9	1.9	2.8	4.7
* 15	47	0.029	4.2	1.7	2.6	4.3
* 16	56	0.032	4.0	1.6	2.4	3.9
* 17	68	0.044	3.4	1.4	2.1	3.6
* 18	82	0.061	2.9	1.3	1.9	3.2
* 19	100	0.085	2.4	1.2	1.8	2.9
* 20	120	0.116	2.1	1.1	1.6	2.7
* 21	150	0.129	2.0	1.0	1.4	2.4
* 22	180	0.180	1.7	0.9	1.3	2.2
* 23	220	0.198	1.6	0.8	1.2	2.0
* 24	270	0.219	1.5	0.7	1.1	1.8

CTP4558