

# Toroidal Inductors

Medium Current

CTP4560

CTP4560 is a medium current inductor with the following data and features:

- **Core type:** 0.80" o.d., Moly-Permalloy Powder, perm 125.
  - **Power rating:** 1.2 watts for temp. rise 50°C.
  - **Typical applications:** Switching Inductors in Switch Mode Power Supplies.
- Four mounting styles are offered:**
- 1 Flying leads (1.00"), for vertical or horizontal mounting.
  - 2 4-pin header, for vertical mounting.
  - 3 Threaded center hole, flying leads (2.00").
  - 4 2-pin header, for vertical mounting.



## MECHANICAL

Style 1

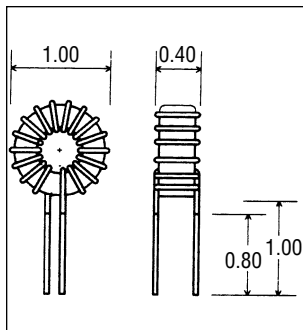

Style 2

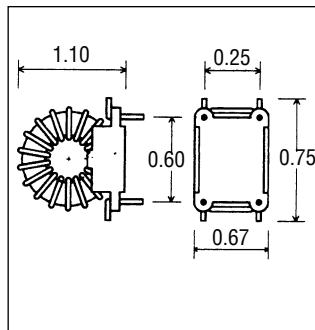

Style 3

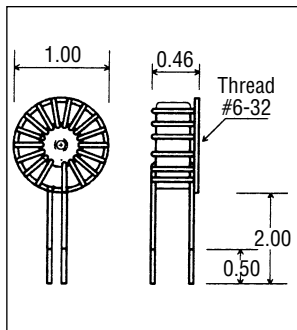

Style 4

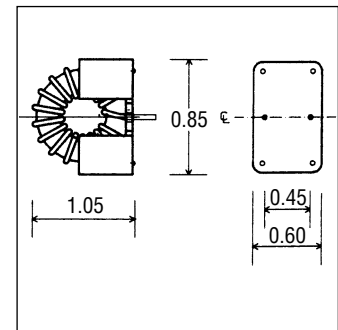

## ELECTRICAL SPECIFICATION

**Ordering Information:** Substitute the style number for the asterisk (\*). Example: CTP4560, Style 1, 56uH. Order: CTP4560 - 116

Part No. CTP4560 -	Ind. (uH)	DCR Ohms	Rated Current Amp. RMS	I (amp.) @ Lsat. 10%	I (amp.) @ Lsat. 25%	I (amp.) @ Lsat. 50%
* 01	3.3	0.003	19.3	11.6	17.4	29.1
* 02	3.9	0.003	18.5	10.7	16.0	26.7
* 03	4.7	0.004	17.8	9.7	14.6	24.4
* 04	5.6	0.004	17.0	8.9	13.4	22.3
* 05	6.8	0.007	12.9	8.1	12.2	20.3
* 06	8.2	0.008	12.4	7.4	11.1	18.4
* 07	10	0.009	11.8	6.7	10.0	16.7
* 08	12	0.009	11.3	6.1	9.1	15.2
* 09	15	0.017	8.5	5.5	8.2	13.6
* 10	18	0.018	8.1	5.0	7.5	12.4
* 11	22	0.020	7.7	4.5	6.8	11.3
* 12	27	0.022	7.4	4.1	6.1	10.2
* 13	33	0.024	7.0	3.7	5.5	9.2
* 14	39	0.027	6.7	3.4	5.1	8.5
* 15	47	0.029	6.4	3.1	4.6	7.7
* 16	56	0.032	6.2	2.8	4.2	7.1

Part No. CTP4560 -	Ind. (uH)	DCR Ohms	Rated Current Amp. RMS	I (amp.) @ Lsat. 10%	I (amp.) @ Lsat. 25%	I (amp.) @ Lsat. 50%
* 17	68	0.035	5.9	2.6	3.8	6.4
* 18	82	0.038	5.6	2.3	3.5	5.8
* 19	100	0.042	5.3	2.1	3.2	5.3
* 20	120	0.046	5.1	1.9	2.9	4.8
* 21	150	0.051	4.8	1.7	2.6	4.3
* 22	180	0.070	4.1	1.6	2.4	3.9
* 23	220	0.098	3.5	1.4	2.1	3.6
* 24	270	0.137	3.0	1.3	1.9	3.2
* 25	330	0.152	2.8	1.2	1.7	2.9
* 26	390	0.209	2.4	1.1	1.6	2.7
* 27	470	0.229	2.3	1.0	1.5	2.4
* 28	560	0.250	2.2	0.9	1.3	2.2

CTP4560