

CTP4562 is a medium current inductor with the following data and features:

- **Core type:** 1.30" o.d., Moly-Permalloy Powder, perm 125.
 - **Power rating:** 3.13 watts for temp. rise 50°C.
 - **Typical applications:** Switching Inductors in Switch Mode Power Supplies.
- Three mounting styles are offered:**
- 1 Flying leads (1.00"), for vertical or horizontal mounting.
 - 2 4-pin header, for vertical mounting.
 - 3 Threaded center hole, flying leads (2.00").



MECHANICAL

Style 1

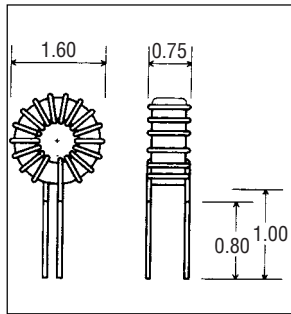

Style 2

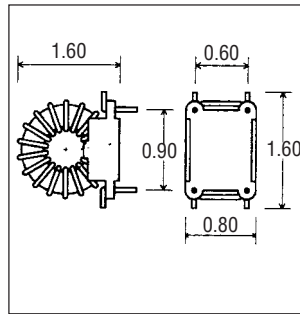

Style 3

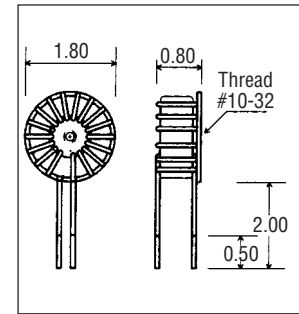

ELECTRICAL SPECIFICATION

Ordering Information: Substitute the style number for the asterisk (*). Example: CTP4562, Style 1, 56uH. Order: CTP4562 - 116

Part No. CTP4562 -	Ind. (uH)	DCR Ohms	Rated Current Amp. RMS	I (amp.) @ Lsat. 10%	I (amp.) @ Lsat. 25%	I (amp.) @ Lsat. 50%	Part No. CTP4562 -	Ind. (uH)	DCR Ohms	Rated Current Amp. RMS	I (amp.) @ Lsat. 10%	I (amp.) @ Lsat. 25%	I (amp.) @ Lsat. 50%
* 01	3.3	0.002	39.9	25.4	38.2	63.6	* 17	68	0.027	10.8	5.6	8.4	14.0
* 02	3.9	0.002	38.4	23.4	35.1	58.5	* 18	82	0.029	10.3	5.1	7.7	12.8
* 03	4.7	0.003	32.7	21.3	32.0	53.3	* 19	100	0.033	9.8	4.6	6.9	11.6
* 04	5.6	0.003	31.4	19.5	29.3	48.8	* 20	120	0.036	9.4	4.2	6.3	10.5
* 05	6.8	0.004	26.7	17.7	26.6	44.3	* 21	150	0.040	8.9	3.8	5.7	9.4
* 06	8.2	0.005	25.5	16.1	24.2	40.4	* 22	180	0.043	8.5	3.4	5.2	8.6
* 07	10	0.005	24.4	14.6	21.9	36.5	* 23	220	0.048	8.1	3.1	4.7	7.8
* 08	12	0.007	20.7	13.3	20.0	33.4	* 24	270	0.053	7.7	2.8	4.2	7.0
* 09	15	0.008	19.7	11.9	17.9	29.8	* 25	330	0.059	7.3	2.5	3.8	6.4
* 10	18	0.011	16.8	10.9	16.3	27.2	* 26	390	0.064	7.0	2.3	3.5	5.9
* 11	22	0.012	16.0	9.9	14.8	24.6	* 27	470	0.070	6.7	2.1	3.2	5.3
* 12	27	0.017	13.5	8.9	13.3	22.2	* 28	560	0.076	6.4	2.0	2.9	4.9
* 13	33	0.019	12.9	8.0	12.1	20.1	* 29	680	0.084	6.1	1.8	2.7	4.4
* 14	39	0.020	12.4	7.4	11.1	18.5	* 30	820	0.092	5.8	1.6	2.4	4.0
* 15	47	0.022	11.8	6.7	10.1	16.9	* 31	1000	0.102	5.5	1.5	2.2	3.7
* 16	56	0.024	11.3	6.2	9.3	15.4	* 32	1200	0.112	5.3	1.3	2.0	3.3

CTP4562