

C&K D Series Miniature Snap-in Power Rocker Switches

Features/Benefits

- Momentary and maintained models
- PC and quick connect terminals
- Recessed bracket available — prevents accidental actuation
- RoHS compliant

Typical Applications

- Small appliances
- Computers and peripherals
- Medical instrumentation



Models Available

Specifications

CONTACT RATING: D10X and D20X Models: 4 AMPS @ 125 V AC; 2 AMPS @ 250 V AC. D50X and D60X Models: 10 AMPS @ 125 V AC; 5 AMPS @ 250 V AC.

ELECTRICAL LIFE: 10,000 make-and-break cycles at full load.

INSULATION RESISTANCE: $10^9 \Omega$ min.

DIELECTRIC STRENGTH: 1,000 Vrms min. @ sea level.

NOTE: For the latest information regarding RoHS compliance, please go to: www.ittcannon.com/rohs.

NOTE: Specifications and materials listed above are for standard switches. For information on specific and custom switches, consult Customer Service Center.

Materials

ACTUATOR & HOUSING: 6/6 nylon (UL 94V-2), color black, finish: matte.

MOVABLE CONTACTS: D10X and D20X Models: Copper, silver plated. D50X and D60X Models: Coin silver, silver plated.

STATIONARY CONTACTS AND TERMINALS: Copper or brass, silver plated.

CONTACT SPRING: Music wire or stainless steel.

OPERATING TEMPERATURE: -30°C to +65°C

Build-A-Switch

To order, simply select desired option from each category and place in the appropriate box. Available options are shown and described on pages H-62 through H-66. For additional options not shown in catalog, consult Customer Service Center.

<p>Switch Function</p> <p>D101 SPDT, On-None-On D102 SPST, On-None-Off D103 SPDT, On-Off-On D105 SPDT, Mom.-Off-Mom. D108 SPDT, Mom.-None-On D201 DPDT, On-None-On D202 DPST, On-None-Off D203 DPDT, On-Off-On D501 SPDT, On-None-On D502 SPST, On-None-Off D503 SPDT, On-Off-On D508 SPDT, Mom.-None-On D601 DPDT, On-None-On D602 DPST, On-None-Off D608 DPDT, Mom.-None-On</p>	<p>Actuator</p> <p>J1 Rocker J5 Lever</p> <p>Actuator Color</p> <p>2 Black 1 White 3 Red</p> <p>Mounting Style/Color</p> <p>S2 Snap-in, black B2 Recessed snap-in actuator guard, black G2 Actuator guard, black S1 Snap-in, white</p> <p>Terminations</p> <p>15 Quick connect A Right angle, PC thru-hole 02 PC Thru-hole 05 Twisted quick connect 06 Extended PC thru-hole 17 Wirable quick connect</p> <p>Actuator Markings</p> <p>NONE No marking D ON-OFF H 0 N Large dot P 0 - R Red rectangle on end U Large dot on end</p>	<p>Contact Material</p> <p>QA Silver (UL/CSA) QF Silver (UL/CSA/VDE)</p>
-------------------------------------------------------------------------------------------------------------------------------------------------------------------------------------------------------------------------------------------------------------------------------------------------------------------------------------------------------------------------------------------------------------------------------------------------------------------------------------------------------------------------------------------------------------------------	------------------------------------------------------------------------------------------------------------------------------------------------------------------------------------------------------------------------------------------------------------------------------------------------------------------------------------------------------------------------------------------------------------------------------------------------------------------------------------------------------------------------------------------------------------------------------------------------------------------------------------------------------------------------------------------------------------------------------------------------------------------------------------------------------------------------	----------------------------------------------------------------------------------------------------



Dimensions are shown: Inch (mm)
Specifications and dimensions subject to change



C&K D Series Miniature Snap-in Power Rocker Switches

SWITCH FUNCTION

NO. POLES	MODEL NO.	AMP RATING*	SWITCH FUNCTION			CONNECTED TERMINALS			SCHEMATIC	
			POS. 1	POS. 2	POS. 3	POS. 1	POS. 2	POS. 3		
SP	D102 D502	4 10	ON	NONE	OFF	1-1A	N/A	OPEN	SPST	
	D101 D501	4 10	ON	NONE	ON			1-1B	1-1B	SPDT
	D103 D503	4 10		OFF						
	D105	4	MOM.	OFF	MOM.					
	D108 D508	4 10	MOM.	NONE	ON					

SPDT

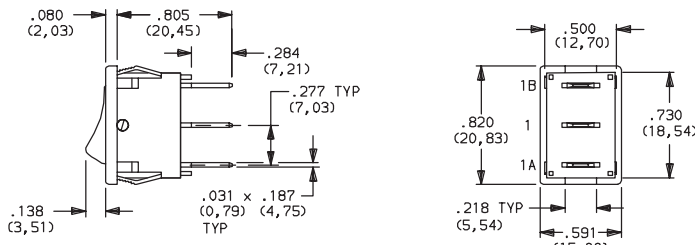

ACTUATOR SHOWN IN POSITION 1

TERMINAL NOS. FOR REF. ONLY

Part number shown: D101J12S215QA

DP	D202 D602	4 10	ON	NONE	OFF	1-1A, 2-2A	N/A	OPEN	DPST	
	D201 D601	4 10	ON	NONE	ON			1-1B, 2-2B	1-1B, 2-2B	DPDT
	D203	4		OFF						
	D608	10	MOM.	NONE						

DPDT

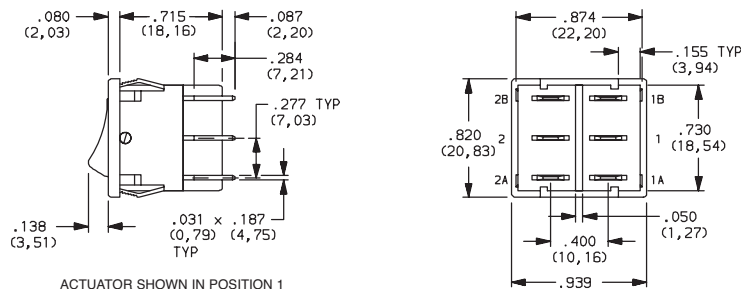

ACTUATOR SHOWN IN POSITION 1

TERMINAL NOS. FOR REF. ONLY

Part number shown: D201J12S215QA

MOM. = Momentary

*AMP RATING: D10X and D20X models: 4 AMPS @ 125 V AC; 2 AMPS @ 250 V AC. D50X and D60X models: 10 AMPS @ 125 V AC; 5 AMPS @ 250 V AC.

All models . DX01, DX02 models also available with . See CONTACT MATERIALS, page H-68.

Rocker



H



ITT

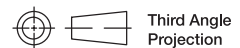

Third Angle Projection

Dimensions are shown: Inch (mm)
Specifications and dimensions subject to change

C&K D Series Miniature Snap-in Power Rocker Switches

ACTUATOR  ACTUATOR COLOR

J1 ROCKER

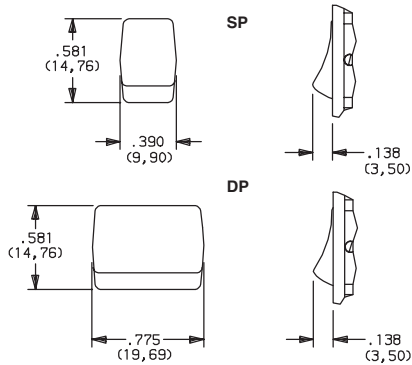

J5 LEVER

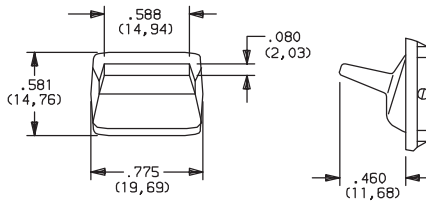

OPTION CODE	ACTUATOR COLOR
2	BLACK
1	WHITE
3	RED

NOTE: Actuator finish: matte. Other colors available, consult Customer Service Center.

J5 actuator available only with DP models D201, D202, D601 and D602.

MOUNTING STYLE/COLOR 

S SNAP-IN

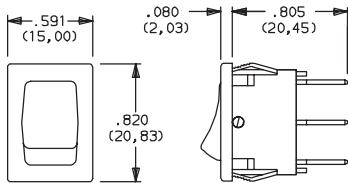

OPTION CODE	HOUSING COLOR
2	(STD.) BLACK
1	WHITE

NOTE: Frame finish on housing: matte. Other colors available, consult Customer Service Center.

B2 RECESSED SNAP-IN ACTUATOR GUARD, BLACK

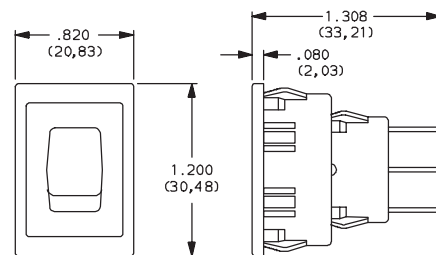

NOTE: Vertical mount, SP models only.

G2 ACTUATOR GUARD, BLACK

NEW!

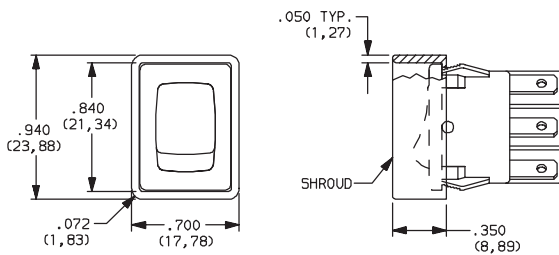

NOTE: Vertical mount, SP models only.

PANEL MOUNTING

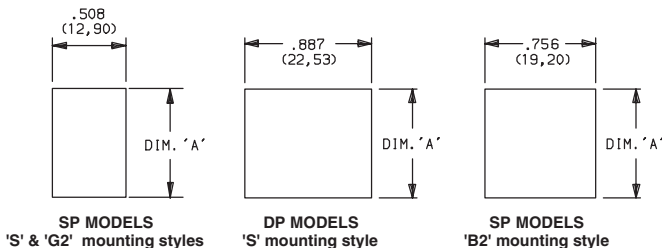

PANEL THICKNESS	DIM 'A' SP & DP MODELS 'S' MOUNTING STYLE	DIM 'A' WITH 'G2' OPTION SP MODELS ONLY	DIM 'A' SP MODELS 'B' MOUNTING STYLE
.030-.049 (0,76) (1,24)	.756 (19,20)	.764 (19,41)	1.068 (27,13)
.049-.079 (1,24) (2,01)	.764 (19,41)	.780 (19,81)	1.076 (27,33)
.079-.118 (2,01) (3,00)	.780 (19,81)	n/a	1.092 (27,74)

NOTE: Blank insert available for SP models only, see page H-68.

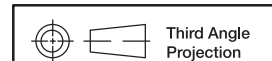

Dimensions are shown: Inch (mm)
Specifications and dimensions subject to change

Rocker



H

C&K D Series Miniature Snap-in Power Rocker Switches

TERMINATIONS

A RIGHT ANGLE, PC THRU-HOLE

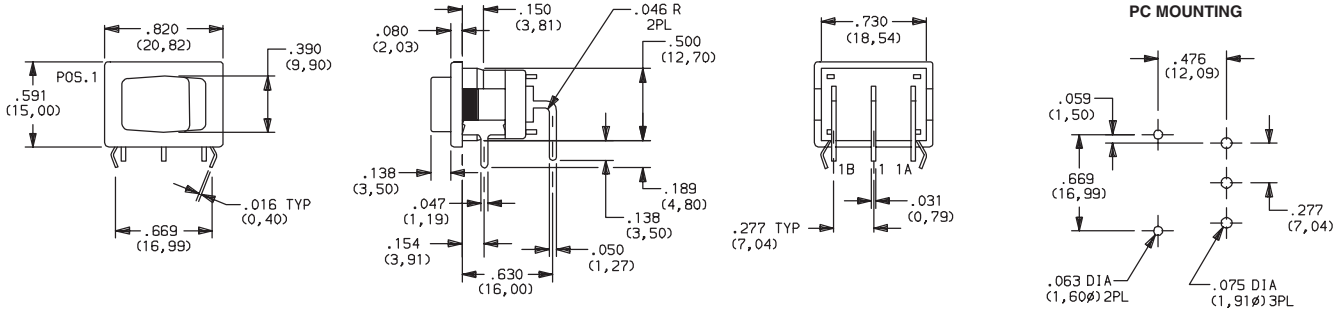

Available with D101, D102, D501, D502 SP models only.

TERMINATIONS

02 PC THRU-HOLE

06 EXTENDED PC THRU-HOLE

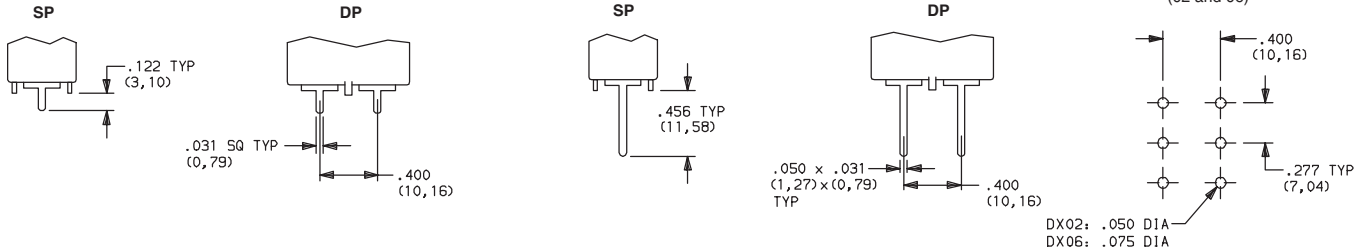

Available with DX01 and DX02 models only.

Available with DX01 and DX02 models only.

15 QUICK CONNECT

05 TWISTED QUICK CONNECT

17 WIRABLE QUICK CONNECT

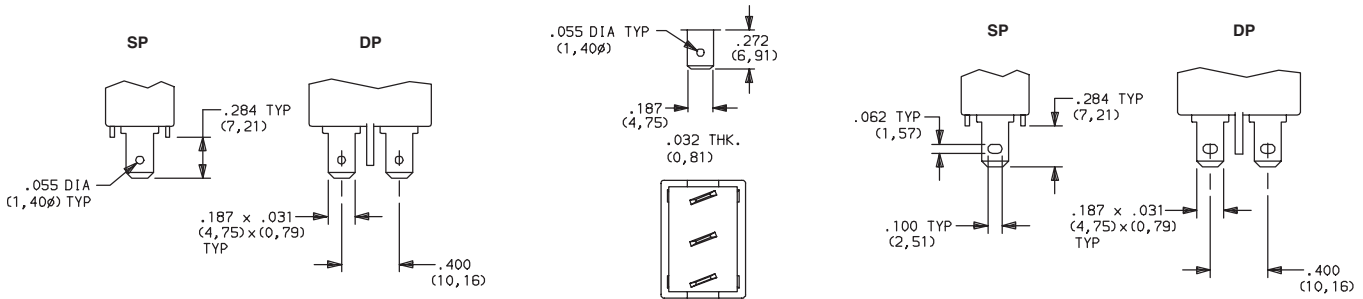

Available with DX01 and DX02 models only.

NOTE: Terminals are twisted.

Available with DX01 and DX02 models only.

ACTUATORS

- NONE** NO MARKING
- D** ON-OFF
- H** O |
- N** LARGE DOT
- P** O -
- R** RED RECTANGLE ON END
- U** LARGE DOT ON END

Rocker

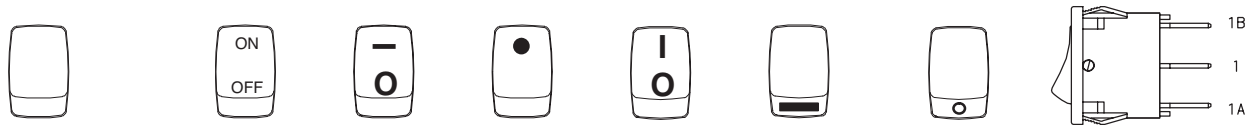

'D, H, P & U' marking options: marking color white, standard for all actuator colors except white. Black marking color, standard for white actuators. 'R & N' marking option: red marking color, standard. Consult Customer Service Center for other available marking colors.

NOTE: Orientation of actuator markings and terminals.



Third Angle Projection

Dimensions are shown: Inch (mm)
Specifications and dimensions subject to change



C&K D Series Miniature Snap-in Power Rocker Switches





CONTACT MATERIAL

OPTION CODE	RoHS COMPLIANT *	RoHS COMPATIBLE *	CONTACT AND TERMINAL MATERIAL	RATINGS	
QA	YES	YES	SILVER ¹	POWER	D10X and D20X MODELS: 4 AMPS @ 125 V AC; 2 AMPS @ 250 V AC (UL/CSA). D50X and D60X MODELS: 10 AMPS @ 125 V AC; 5 AMPS @ 250 V AC (UL/CSA).
QF	YES	YES			D10X and D20X MODELS: 4 AMPS @ 125 V AC; 2 AMPS @ 250 V AC (UL/CSA). 4(2) AMPS @ 125 V AC; 2(1) AMPS @ 250 V AC, T85 (VDE). D50X and D60X MODELS: 10 AMPS @ 125 V AC; 5 AMPS @ 250 V AC (UL/CSA). 10(6) AMPS @ 125 V AC; 5(3) AMPS @ 250 V AC, T85 (VDE).

¹MOVABLE CONTACT: D10X and D20X MODELS: Copper, silver plated.
D50X and D60X MODELS: Coin silver, silver plated.

STATIONARY CONTACTS & TERMINALS: Copper or brass, silver plated.

NOTE: For the latest information regarding RoHS compliance, please go to: www.ittcannon.com/rohs.

All models   with all options. DX01, DX02 models    when ordered with 'QF' contact material.

AVAILABLE HARDWARE

Insert
SP Only

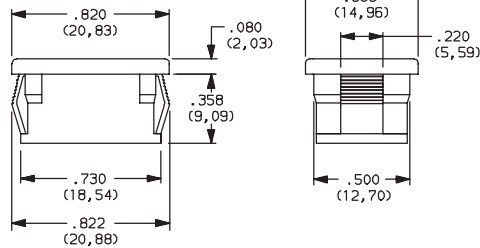

PART NO.

057190200 BLACK

Material: Nylon 6/6
Finish: Matte

Recessed Actuator Guard,
SP Only



PART NO.

057090100 BLACK

Material: 6/6 Nylon
Finish: Matte

Actuator Guard

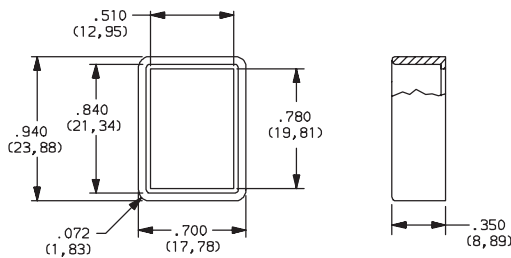

PART NO.

104C02000

Material: PBT thermoplastic
Finish: Matte



Dimensions are shown: Inch (mm)
Specifications and dimensions subject to change

Rocker



H