

### INTRODUCTION:

Adam Tech Straight PCB tail D-Sub connectors are a popular interface for many I/O applications. Offered in 9, 15, 25, 37 and 50 positions they are an excellent choice for a low cost, sturdy, full metal body industry standard connection. These connectors are manufactured with precision stamped or machined turned contacts offering a choice of contact plating and a wide selection of mating and mounting options.

### FEATURES:

- Industry standard compatibility
- Durable metal shell design
- Precision formed contacts
- Variety of Mating and mounting options

### MATING CONNECTORS:

Adam Tech D-Subminiatures and all industry standard D-Subminiature connectors.

### SPECIFICATIONS:

#### Material:

Standard insulator: PBT, 30% glass reinforced, rated UL94V-0

Optional Hi-Temp insulator: Nylon 6T

Insulator Colors: Black (White optional)

Contacts: Phosphor Bronze

Shell: Steel, Tin or Zinc plated

Hardware: Brass, Nickel plated

#### Contact Plating:

Gold Flash (15 and 30 µin Optional) over Nickel underplate overall

#### Electrical:

Operating voltage: 250V AC / DC max.

Current rating: 5 Amps max.

Contact resistance: 20 mΩ max. initial

Insulation resistance: 5000 MΩ min.

Dielectric withstanding voltage: 1000V AC for 1 minute

#### Mechanical:

Insertion force: 0.75 lbs max

Extraction force: 0.44 lbs min

#### Temperature Rating:

Operating temperature: -65°C to +125°C

Soldering process temperature:

Standard insulator: 235°C

Hi-Temp insulator: 260°C

### PACKAGING:

Anti-ESD plastic trays

### APPROVALS AND CERTIFICATIONS:

UL Recognized File No. E224053

CSA Certified File No. LR1578596

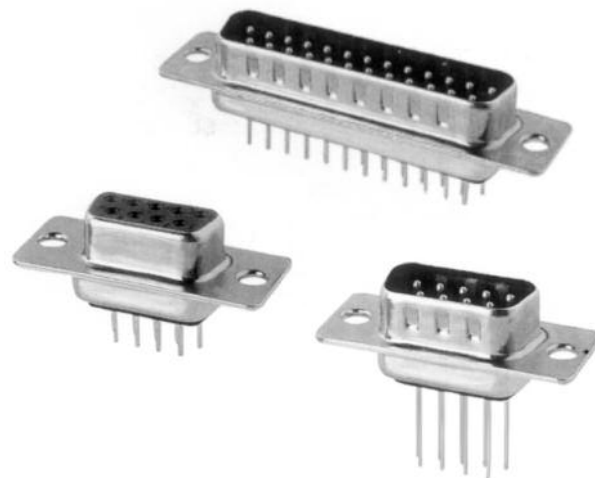

### ORDERING INFORMATION

DB25	ST	1	SL
<b>SHELL SIZE/ POSITIONS</b> DE09 = 9 Position DA15 = 15 Position DB25 = 25 Position DC37 = 37 Position DD50 = 50 Position		<b>MOUNTING OPTIONS</b> Blank = .120" Mounting Holes SL = Bottom side riveted #4-40 Clinch Nuts JS = Top side riveted #4-40 Jackscrews BL = Riveted #4-40 Internal Threaded Standoffs with Boardlocks R = Riveted Round Jack Screws JSL = Bottom side riveted #4-40 Clinch Nuts with Jack Screws installed	
<b>CONTACT TYPE</b> PT = Plug, Straight PCB Tail, Standard Profile ST = Socket, Straight PCB Tail, Standard Profile PE = Plug, Straight PCB Tail, High Profile SE = Socket, Straight PCB Tail, High Profile		<b>TERMINAL LENGTH</b> 1 = Standard tail length for .062" thru .125" PCB's (E = .189") 2 = Wire wrap tail (E = .512")	

### OPTIONS:

Add designator(s) to end of part number

15 = 15 µin gold plating in contact area

30 = 30 µin gold plating in contact area

EMI = Ferrite filtered version for EMI / RFI suppression (Page 72)

HT = Hi-Temp insulator for hi-temp soldering processes up to 260°C

### MOUNTING OPTIONS

#### PLUG

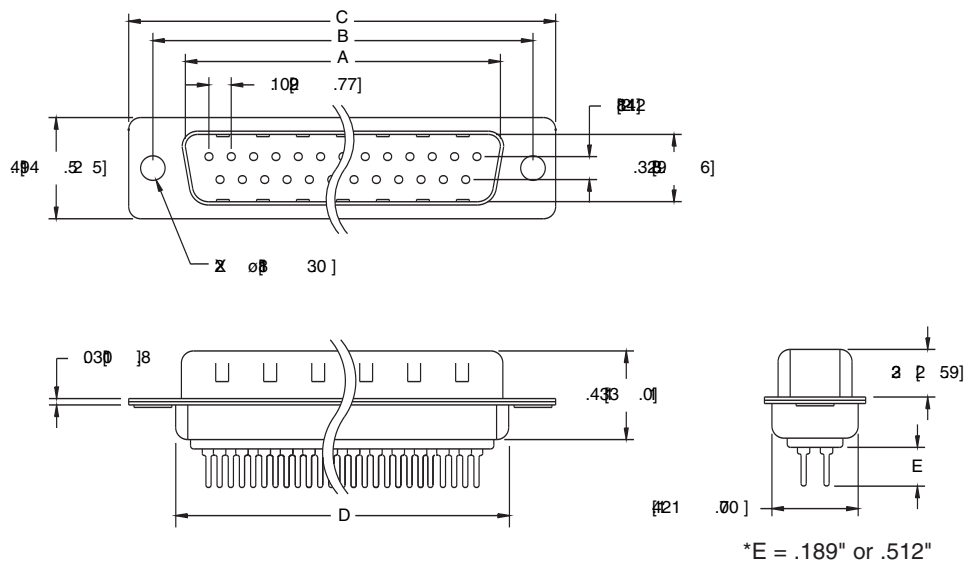

#### SOCKET

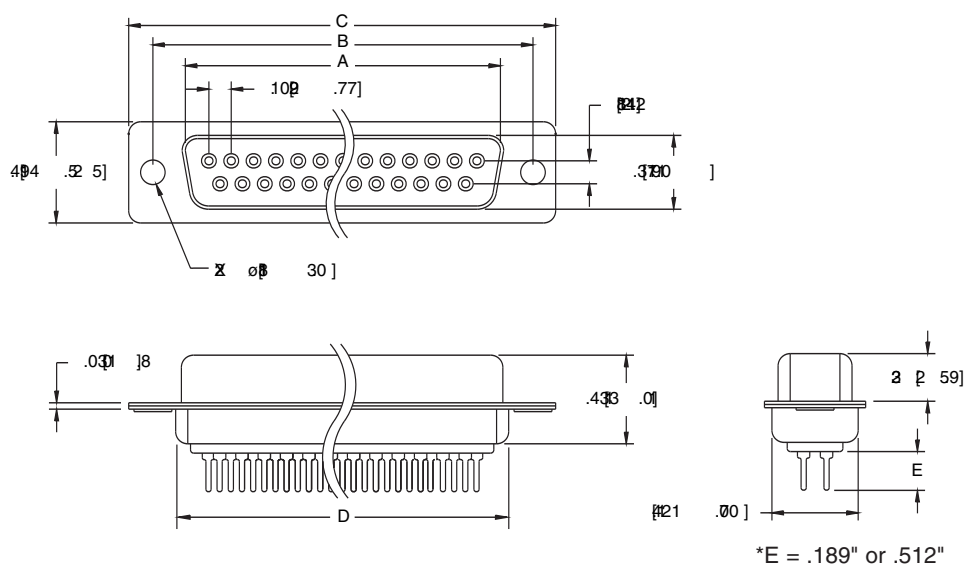

**SL Option**  
Bottom side riveted #4-40 Clinch Nuts

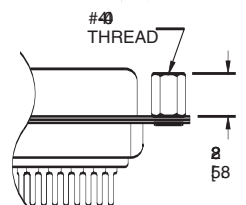

**JS Option**  
Top side riveted #4-40 Jack Screws

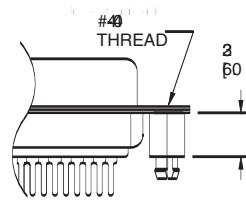

**BL Option**  
#4-40 Threaded Boardlocks

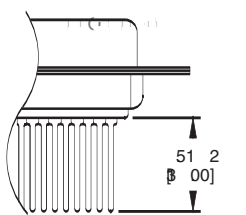

**Wire Wrap Tail Option**  
Terminal length -2 wire wrap tail

Unit: Inch [mm]

Positions	PLUG	SOCKET	DIMENSIONS		
	A	A	B	C	D
9	.666 [16.92]	.643 [16.33]	.984 [24.99]	1.213 [30.81]	.756 [19.20]
15	.994 [25.25]	.971 [24.66]	1.312 [33.32]	1.541 [39.14]	1.091 [27.70]
25	1.534 [38.96]	1.511 [38.38]	1.852 [47.04]	2.088 [53.04]	1.618 [41.10]
37	2.182 [55.43]	2.159 [54.84]	2.500 [63.50]	2.729 [69.32]	2.256 [57.30]
50	2.079 [52.81]	2.064 [52.43]	2.406 [61.11]	2.637 [67.00]	2.169 [55.10]

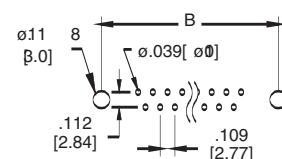

**Recommended PCB Layout**