

■ 外形寸法(mm) / Dimensions (mm)

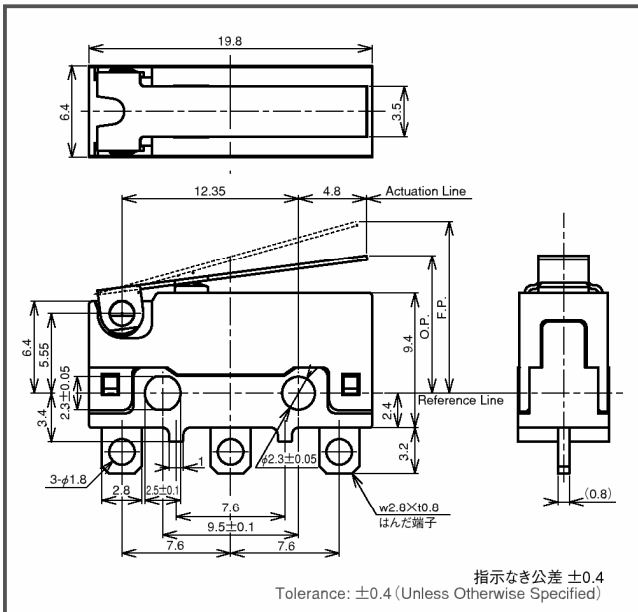

■ 安全規格 / Agency Approvals

シリーズ名	DE1L	DE2L	DE3L
UL	適用規格 File No.	UL1054 E300187	
VDE	適用規格 File No.	EN61058-1 40001153	
SEMKO	適用規格 File No.	EN61058-1 413976	

【特長】 [Features]

- 超小型
- 豊富な端子バリエーション
- 接点ギャップ1mm以上
- Compact size: (19.8×6.4×9.4mm)
- Seven terminal variations
- 1mm minimum contact gap

■ 取得規格 / Agency Approved



✓RoHS対応品

■ 定格 / Rating

DE1	UL, CUL	3A, 125 / 250VAC 3A, 30VDC
	VDE, SEMKO	3A, 30VDC
DE2	UL, CUL	5A, 30VDC 1A, 42VDC
	VDE, SEMKO	5A, 30VDC 1A, 42VDC
DE3	UL, CUL	0.1A, 125 / 250VAC 0.1A, 30VDC
	VDE, SEMKO	0.1A, 30VDC

■ 性能 / Performance

回路構成 Circuitry	単極双投 S.P.D.T.	
接点ギャップ Contact Gap	1mm以上 1mm MIN	
接触抵抗 Contact Resistance	50mΩ以下 50mΩ MAX	
機械的寿命 Mechanical Life	300,000回以上 300,000 cycles MIN	
電気的寿命 Electrical Life	100,000回以上 ただしDE1の3A, 125 / 250VACで使用した場合は1万回以上 100,000 cycles MIN	
安全規格上の 電気的寿命 Agency Approved Life	UL / CUL	6,000回 (C Type) 6,000 cycles (C Type) 100,000回 (L Type) 100,000 cycles (L Type) ただしDE1のAC定格は6千回
	VDE / SEMKO	100,000回 100,000 cycles
使用温湿度範囲 Temperature Rating Range	-25 ~ +85℃ 85%RH以下(ただし結露なきこと) -25 ~ +85℃ 85%RH Below (Non Condensation)	
絶縁抵抗 Insulation Resistance	100MΩ以上 (DC500V) 100MΩ MIN (DC500V)	
耐電圧 Dielectric Strength	AC1000V 1分間 AC1000V 1 minute	
耐振性 Vibration Proof	10~55Hz 全振幅1.5mm 10~55Hz Peak to peak amplitude 1.5mm	
耐衝撃性 Shock Proof	294m/s ² (30G)	

■ 材質 / Material

(難燃性 / Flame-Retardant)

ベース Base	PPS樹脂 PPS	UL94V-0
カバー Cover	PBT樹脂 PBT	UL94V-0
ボタン Button	PBT樹脂 PBT	UL94V-0
ブレード Blade	ベリリウム銅 Beryllium copper	
端子 Terminal	黄銅 + 銀メッキ Brass + Silver plated	
接点 Contact	銀合金 (DE1, DE2) Silver alloy (DE1, DE2) 銀合金 + 金メッキ (DE3) Silver alloy + Gold plated (DE3)	
アクチュエータ Actuator	ステンレス Stainless steel	
ローラアクチュエータ Roller Actuator	ステンレス Stainless steel ナイロン樹脂 (ローラー) PA66 (Roller) アルミニウム (リベット) Aluminum (Rivet)	

DE シリーズ DE Series

■ 品名構成表 / Ordering Information

DE 2 L - A A A A

コード Code	定格 Rating	VDE/SEMKO
1	3 A, 30 VDC 3 A, 125-250 VAC	3 A, 30 VDC
2	5 A, 30 VDC 1 A, 42 VDC	5 A, 30 VDC 1 A, 42 VDC
3	0.1 A, 30 VDC 0.1 A, 125-250 VAC	0.1 A, 30 VDC

コード Code	UL認定寿命 UL Approval (Life Test Cycle)
C	6,000 回 6,000 Cycles
L	100,000 回 (DC 定格) 100,000 Cycles (DC)

コード Code	端子形状 Terminal Configuration
A	はんだ端子 Short Solder 2.8×0.8
B	#110Q.C. (Short) 2.8×0.5Q.C., l=8
C	PCB PCB1×0.8
D	PCBライト PCB Right 1×0.8
E	PCBレフト PCB Left 1×0.8
F	#110Q.C. (Long) 2.8×0.5Q.C., l=9.6
H	PCB KINK PCB1×0.8 Self-standing

コード Code	回路構成 Circuitry
A	単極双投 S.P.D.T. NC/NO
B	単極単投 (NO) S.P.S.T. NO only
C	単極単投 (NC) S.P.S.T. NC only

コード Code	アクチュエータ長 Auxiliary Actuator-length
AA	B C D G
ボタンタイプ Button	
ストレートレバー Straight	L 4.8 7 42 13.5
ローラー Roller	R 2.5 4.7 39.7
シュミレート Simulated roller	S 2.5 4.7 39.7

アクチュエータ長
Actuator-length
動作位置
at Operating Point

■ 端子形状図 / Terminals

指示なき公差 ±0.4
Tolerance: ±0.4 (Unless Otherwise Specified)

■ 穴加工寸法図 / PCB Footprint

プリント基板加工寸法 / PCB Footprint

部品面パターン禁止区域

取り付け穴加工寸法 / Mounting hole

2-φ2.4±0.1
または2-M2.3ネジ穴

スナップスイッチ Snap-Action Switches

■ 適用電流電圧範囲/Current Voltage Range

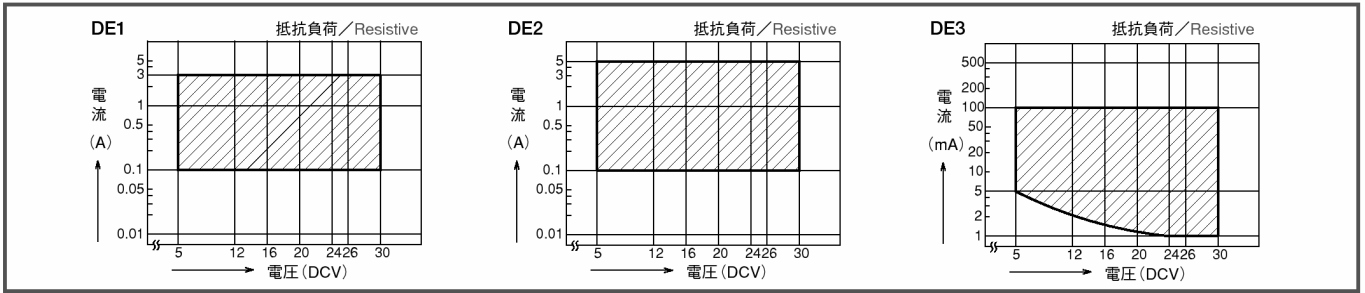

■ 動作特性/Operating Characteristics

	OF	PT	OP※	OT	MD	FP※
DE□□-□□AA	196cN Max.	1.0mm Max.	7.7 ±0.4mm	0.4mm Min.	0.3mm Max.	8.4 ±0.4mm
DE□□-□□LB	58.8cN Max.	4.0mm Max.	9.0 ±1.2mm	1.3mm Min.	0.9mm Max.	11.6 ±1.2mm
DE□□-□□LC	58.8cN Max.	4.8mm Max.	9.2 ±1.2mm	1.3mm Min.	1.0mm Max.	12.6 ±1.2mm
DE□□-□□LD	29.4cN Max.	14.0mm Max.	12.1 ±3.0mm	3.6mm Min.	5.8mm Max.	23.9 ±3.0mm
DE□□-□□RB	78.5cN Max.	3.3mm Max.	14.5 ±1.2mm	1.2mm Min.	0.8mm Max.	17.0 ±1.2mm
DE□□-□□RC	63.7cN Max.	3.6mm Max.	14.8 ±1.4mm	1.2mm Min.	0.9mm Max.	17.4 ±1.4mm
DE□□-□□SB	78.4cN Max.	3.3mm Max.	14.5 ±1.2mm	1.2mm Min.	0.8mm Max.	17.0 ±1.2mm
DE□□-□□SC	63.7cN Max.	3.6mm Max.	14.8 ±1.4mm	1.2mm Min.	0.9mm Max.	17.4 ±1.4mm

注1、※印はReference Line (A) からの距離/Distance from Reference Line (A)
注2、Reference Line AとReference Line Bの差は3.4 ±0.1mm/ Difference between Reference Line A & B is 3.4 ±0.1mm

■ 外形寸法 (mm) /Dimensions (mm)

形名及び型番号 Type	寸法図 Dimensions
DE2L-BAAA	<p>指示なき公差 ±0.4 Tolerance: ±0.4 (Unless Otherwise Specified)</p>
DE2L-BALB	<p>指示なき公差 ±0.4 Tolerance: ±0.4 (Unless Otherwise Specified)</p>
DE2L-CALB	<p>指示なき公差 ±0.4 Tolerance: ±0.4 (Unless Otherwise Specified)</p>
DE2L-DALB	<p>指示なき公差 ±0.4 Tolerance: ±0.4 (Unless Otherwise Specified)</p>

DEシリーズ

DE Series

■ 外形寸法 (mm) / Dimensions (mm)

形名及び型番号
Type

寸法図
Dimensions

DE2L-FAAA

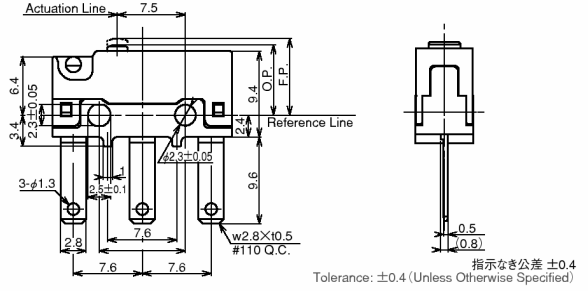
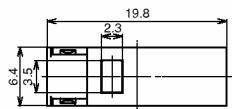
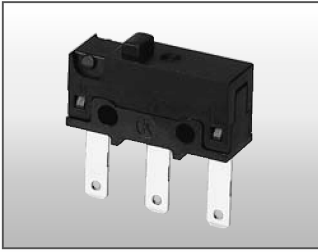

DE2L-HBLG

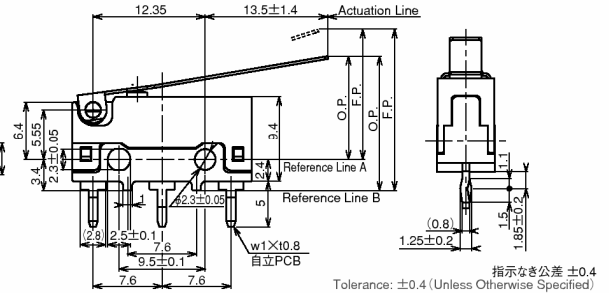
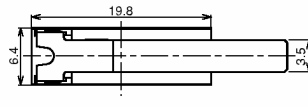
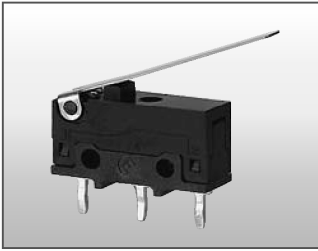

DE3L-AALB

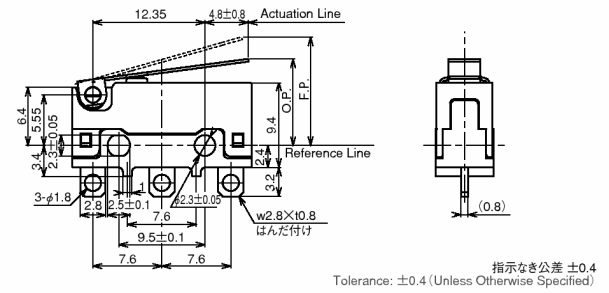

DE3L-AALD

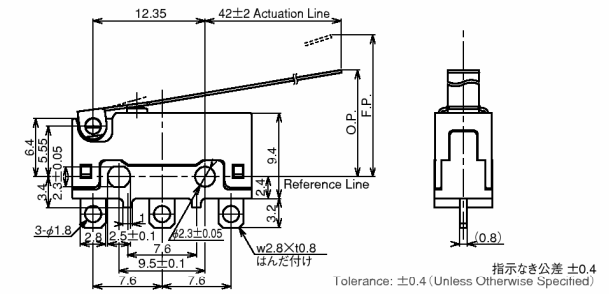
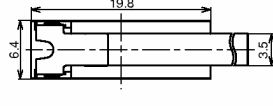
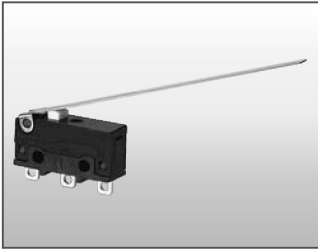

DE2L-AALB

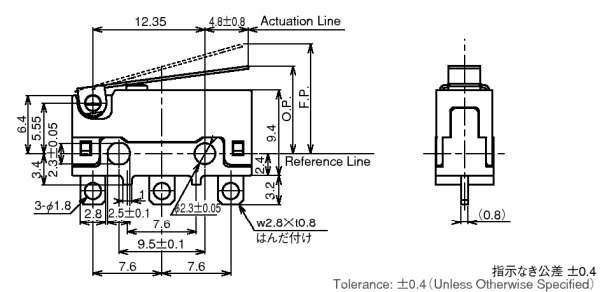

DE3L-BALB

