

FEATURES

- 15 Watts Output Power
- Output Current up to 4A
- High Efficiency up to 88%
- Fixed Switching Frequency
- Six-Sided Continuous Shield
- 2:1 Wide Input Voltage Range
- Standard 2 x 1 x 0.4 inch Package
- ISO9001 Certified Manufacturing Facilities
- Compliant to RoHS EU Directive 2002/95/EC
- Options: Positive Logic and Negative Logic Remote ON/OFF

APPLICATIONS

- Measurement
- Wireless Network
- Telecom/Datacom
- Industry Control System
- Semiconductor Equipment



SPECIFICATIONS: DM Series

All specifications apply @ 25°C ambient unless otherwise noted

INPUT SPECIFICATIONS

Input Voltage Range	12V nominal input	9 - 18 VDC
	24V nominal input	18 - 36 VDC
	48V nominal input	36 - 75 VDC
Input Filter		Pi Type
Input Surge Voltage (100ms max)	12V input	36 VDC
	24V input	50 VDC
	48V input	100 VDC
Input Reflected Ripple Current (Note 2).....		20mA _{p-p}
Start Up Time (nominal Vin and constant resistive load).....		20ms typ.
Remote ON/OFF (Option) (Note 7)		
(Positive Logic).....	DC-DC ON	Open or 3.5V < Vr < 12V
	DC-DC OFF	Short or 0V < Vr < 1.2V
(Negative Logic).....	DC-DC ON	Short or 0V < Vr < 1.2V
	DC-DC OFF	Open or 3.5V < Vr < 12V
Input Current of Remote Control Pin (nominal Vin)		-0.5mA ~ +1mA
Remote Off State Input Current (nominal Vin).....		20mA

OUTPUT SPECIFICATIONS

Output Voltage		see table
Voltage Accuracy (nominal Vin and full load)		±1%
Output Current		see table
Output Power		15 watts max.
Line Regulation (LL to HL at FL).....		±0.5%
Load Regulation (min load to full load)	Single Output.....	±0.5%
	Dual Output.....	±1%
Cross Regulation (Dual) (Asymmetrical load 25% / 100% FL)		±5%
Minimum Load (See Note 6)		see table
Ripple/Noise (20 MHz BW).....	Single Output.....	50mV _{p-p}
	Dual Output	75mV _{p-p}
Temperature Coefficient		±0.02% / °C max.
Transient Response Recovery Time (25% load step)		250us

PROTECTION SPECIFICATIONS

Over Voltage Protection.....	3.3V output	3.9V
(zener diode clamp)	5V output	6.2V
	12V output	15V
	15V output	18V
Over Load Protection (% of full load at nominal input).....		150% max.
Short Circuit Protection.....		Hiccup, automatic recovery

GENERAL SPECIFICATIONS

Efficiency		see table
Switching Frequency	Single Output	500KHz typ.
	Dual Output.....	300KHz typ.
Isolation Voltage (Input to Output).....		1600VDC min.
Isolation Resistance		10 ⁹ ohms min.
Isolation Capacitance		300pF max.

ENVIRONMENTAL SPECIFICATIONS

Operating Temperature		-40°C ~ +85°C (with derating)
Storage Temperature		-55°C ~ +105°C
Maximum Case Temperature		100°C
Relative Humidity.....		5% to 95% RH
Thermal Impedance (Note 8)		
	Natural Convection	12°C / Watt
	Natural Convection with Heat-Sink.....	10°C / Watt
Thermal Shock		MIL-STD-810F
Vibration		10~55Hz, 10G, 30 minutes along X, Y, and Z
MTBF (See Note 1)		2.041 x 10 ⁶ hours

PHYSICAL SPECIFICATIONS

Weight		27g (0.95 oz)
Dimensions.....		2.0 x 1.0 x 0.40 inches (50.8 x 25.4 x 10.2 mm)
Case Material		Nickel-coated copper
Base Material.....		Non-conductive black plastic
Potting material.....		Epoxy (UL94-V0)
Shielding.....		six-sided

SAFETY & EMC

Approvals and Standards		IEC60950-1, UL60950-1, EN60950-1	
EMI (Note 9)		EN55022	Class A
ESD	EN61000-4-2.....	Air ±8KV	Perf. Criteria B
		Contact ±6KV	
Radiated Immunity.....	EN61000-4-3	10V/m	Perf. Criteria A
Fast Transient.....	EN61000-4-4	±2KV	Perf. Criteria B
Surge (Note 10).....	EN61000-4-5	±1KV	Perf. Criteria B
Conducted Immunity...EN61000-4-6.....		10 Vrms	Perf. Criteria A

Due to advances in technology, specifications subject to change without notice

OUTPUT VOLTAGE / CURRENT RATING CHART

Model Number	Input Range	Output Voltage	Output Current		Output ⁽⁴⁾ Ripple & Noise	Input Current		Efficiency ⁽⁴⁾	Capacitor ⁽⁵⁾ Load max
			Min. load	Full load		No load ⁽³⁾	Full load ⁽²⁾		
DM12S3.3-4000	12 VDC (9 - 18 VDC)	3.3 VDC	0mA	4000mA	50mVp-p	30mA	1467mA	79%	10200uF
DM12S5-3000		5 VDC	15mA	3000mA	50mVp-p	25mA	1603mA	82%	7050uF
DM12S12-1250		12 VDC	0mA	1250mA	50mVp-p	25mA	1524mA	86%	1035uF
DM12S15-1000		15 VDC	0mA	1000mA	50mVp-p	20mA	1524mA	86%	705uF
DM12D5-1500		± 5 VDC	0mA	± 1500mA	75mVp-p	20mA	1582mA	83%	± 1020uF
DM12D12-625		± 12 VDC	0mA	± 625mA	75mVp-p	30mA	1524mA	86%	± 495uF
DM12D15-500	± 15 VDC	±10mA	± 500mA	75mVp-p	35mA	1563mA	84%	± 165uF	
DM24S3.3-4000	24 VDC (18 - 36 VDC)	3.3 VDC	0mA	4000mA	50mVp-p	15mA	724mA	80%	10200uF
DM24S5-3000		5 VDC	15mA	3000mA	50mVp-p	10mA	781mA	84%	7050uF
DM24S12-1250		12 VDC	0mA	1250mA	50mVp-p	20mA	772mA	85%	1035uF
DM24S15-1000		15 VDC	10mA	1000mA	50mVp-p	15mA	772mA	85%	705uF
DM24D5-1500		± 5 VDC	0mA	± 1500mA	75mVp-p	15mA	781mA	84%	± 1020uF
DM24D12-625		± 12 VDC	0mA	± 625mA	75mVp-p	25mA	762mA	86%	± 495uF
DM24D15-500	± 15 VDC	0mA	± 500mA	75mVp-p	25mA	762mA	86%	± 165uF	
DM48S3.3-4000	48 VDC (36 - 75 VDC)	3.3 VDC	0mA	4000mA	50mVp-p	10mA	357mA	81%	10200uF
DM48S5-3000		5 VDC	0mA	3000mA	50mVp-p	20mA	396mA	83%	7050uF
DM48S12-1250		12 VDC	10mA	1250mA	50mVp-p	15mA	377mA	87%	1035uF
DM48S15-1000		15 VDC	0mA	1000mA	50mVp-p	15mA	381mA	86%	705uF
DM48D5-1500		± 5 VDC	0mA	± 1500mA	75mVp-p	10mA	386mA	85%	± 1020uF
DM48D12-625		± 12 VDC	0mA	± 625mA	75mVp-p	15mA	372mA	88%	± 495uF
DM48D15-500	± 15 VDC	0mA	± 500mA	75mVp-p	15mA	377mA	87%	± 165uF	

NOTES

- BELLCORE TR-NWT-000332. Case 1: 50% Stress, Temperature at 40°C. (Ground fixed and controlled environment)
- Maximum value at nominal input voltage and full load
- Typical value at nominal input voltage and no load.
- Typical value at nominal input voltage and full load.
- Test by minimum Vin and constant resistive load.
- The output requires a minimum loading on the output to maintain specified regulation. Operation under no-load condition will not damage these devices, however they may not meet all listed specifications.
- The ON/OFF control pin voltage is referenced to -Vin.
To order positive logic ON-OFF control add the suffix P (Ex: DM48S5-3000P)
To order negative logic ON-OFF control add the suffix R (Ex: DM48S5-3000R)
- Heat sink is optional, consult factory.
- The DM Series can meet EN55022 Class A with an external capacitor in parallel with the input pins.
Recommended: 12Vin: 6.8µF/50V 24Vin: 2.2µF/50V 48Vin: 1.5µF/100V
- An external filter capacitor is required if the module has to meet EN61000-4-5. The filter capacitor Wall Industries suggests: Nippon chemi-con KY Series 220uF/100V ESR 48mΩ.

DERATING CURVES & EFFICIENCY GRAPHS

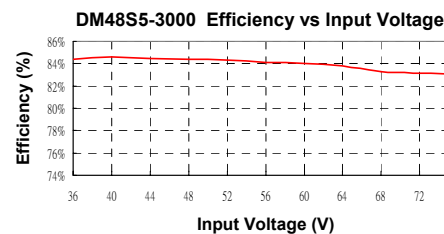
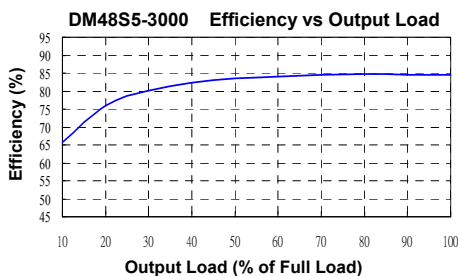
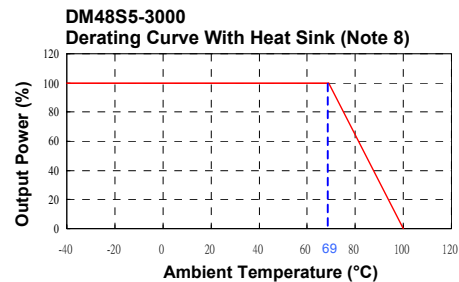
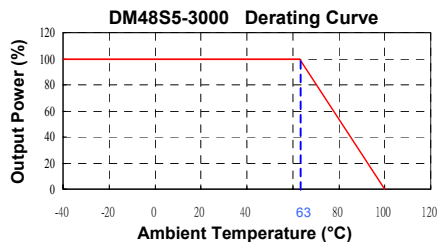

MECHANICAL DRAWING

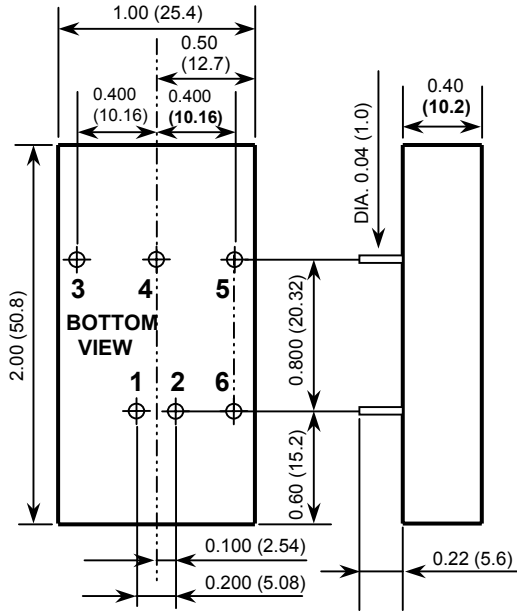

PIN CONNECTION		
PIN	SINGLE	DUAL
1	+INPUT	+INPUT
2	-INPUT	-INPUT
3	+OUTPUT	+OUTPUT
4	NO PIN	COMMON
5	-OUTPUT	-OUTPUT
6	CTRL (Option)	CTRL (Option)

- All dimensions in Inches (mm)
Tolerance: X.XX±0.02 (X.X±0.5)
X.XXX±0.01 (X.XX±0.25)
- Pin pitch tolerance ±0.01(0.25)
- Pin dimension tolerance ±0.004 (0.1)

FIGURE 1

Recommended Filter for EN55022 Class B Compliance

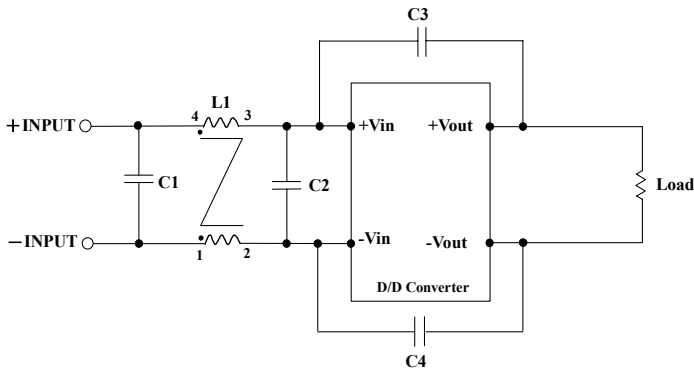
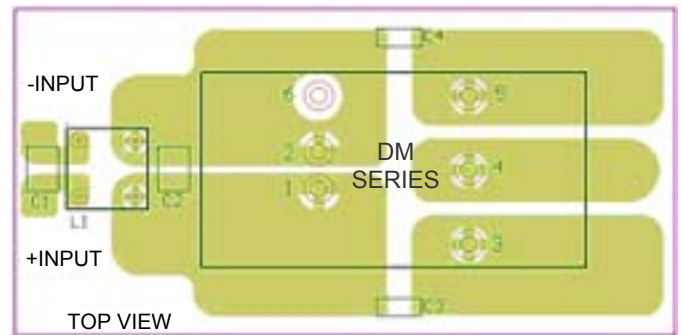

FIGURE 2

Recommended EN55022 Class B Filter Circuit Layout



The components used in the Figure 1, together with the manufacturers' part numbers for these components, are as follows:

	C1	C2	C3	C4	L1
DM12xxx-xxxx	4.7uF/50V	N/A	1000pF/2KV	1000pF/2KV	325uH Common Choke
DM24xxx-xxxx	3.3uF/50V	N/A	1000pF/2KV	1000pF/2KV	325uH Common Choke
DM48xxx-xxxx	2.2uF/100V	2.2uF/100V	1000pF/2KV	1000pF/2KV	325uH Common Choke