

SPECIFICATIONS

Electrical Ratings	5A @ 120VAC, 28VDC; 2A @ 250VAC See Contact Options
Electrical Life	30,000 cycles typical
Contact Resistance	< 10 mΩ max initial @ 2-4VDC, 100mA
Dielectric Strength	1500Vrms min
Insulation Resistance	> 100MΩ min
Operating Temperature	-40°C to 85°C
Storage Temperature	-40°C to 85°C



MATERIALS ←RoHS COMPLIANT







Actuator	6/6 Nylon
Housing	DAP – Diallyl Phthalate
Cover	Stainless Steel
Contacts	Copper Alloy, Silver Plated
Terminals	Brass, Silver Plated



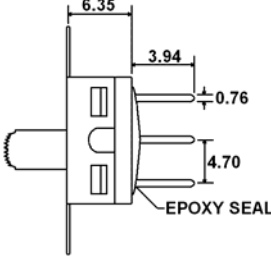
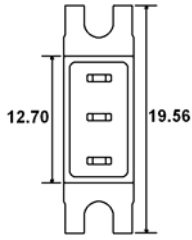

UL [®] **us** - E222871

ORDERING INFORMATION

Series:	1	2	03	A1	B	C	E	B
Number of Poles:								
1 = SPDT								
2 = DPDT								
Switch Function:								
01 = ON-NONE-ON								
02 = ON-NONE-(ON)								
03 = ON-OFF-ON								
Actuator:								
A1 = 5.08mm								
A2 = 7.24mm								
A3 = 9.40mm								
A4 = 3.60mm								
A7 = 12.32mm								
D1 = 5.08mm **Only available with DPDT								
Terminals:								
B = Solder Lug								
C = PC Pin								
D = Quick Connect								
H = Horizontal Mount, Right Angle PC Pin								
V = Vertical Mount, Right Angle PC Pin								
S20 = PC Pin with Support Bracket								
Contacts:								
Q = Silver Plated								
R = Gold Plated								
G = Gold over Silver Plated								
Epoxy Seal:								
E = Epoxy Seal								
Mounting Style:								
A = No Mounting Ears								
B = With Mounting Ears								

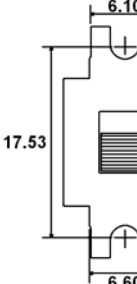
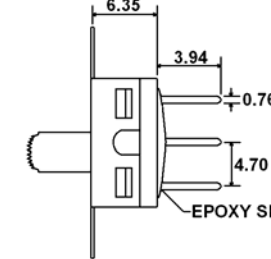
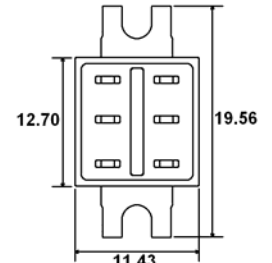
SWITCH FUNCTION

	Function	Toggle Position					
							
		1	ON	NONE			
SPDT	2	ON	NONE	(ON)			
	3	ON	OFF	ON			
	Terminals	2-3	---	2-1			

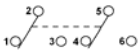
	Function	Toggle Position					
							
		1	ON	NONE			
DPDT	2	ON	NONE	(ON)			
	3	ON	OFF	ON			
	Terminals	2-3 5-6	---	2-1 5-4			

ACTUATOR OPTIONS

** Actuator lengths shown with B, C, D, or S20 Terminals, subtract 0.36mm for H or V terminals.

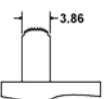
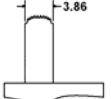
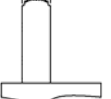
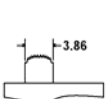
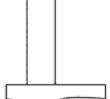
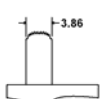
					
A1	A2	A3	A4	A7	D1

TERMINAL OPTIONS

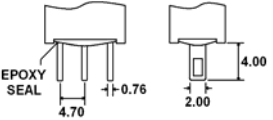
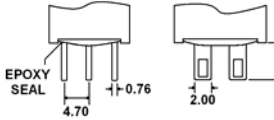
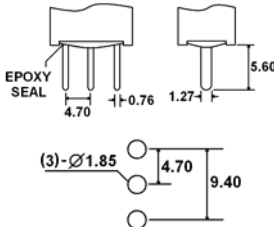
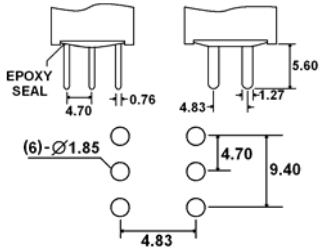
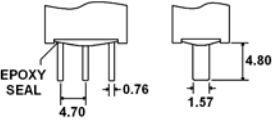
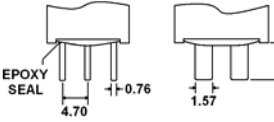
			
B (Single Pole)	B (Double Pole)	C (Single Pole)	C (Double Pole)
			
D (Single Pole)	D (Double Pole)		

TERMINAL OPTIONS

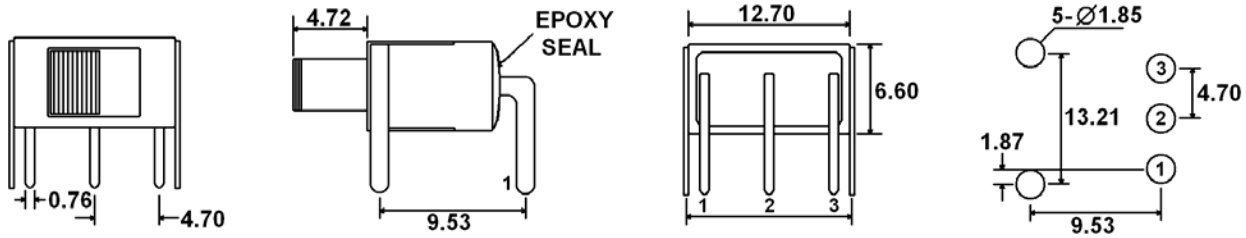

H = Horizontal Mount, Right Angle PC Pins (Single Pole)

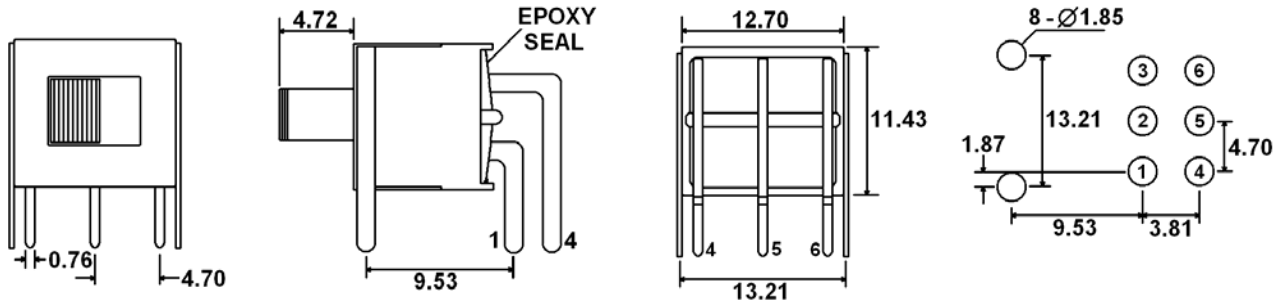

H = Horizontal Mount, Right Angle PC Pins (Double Pole)

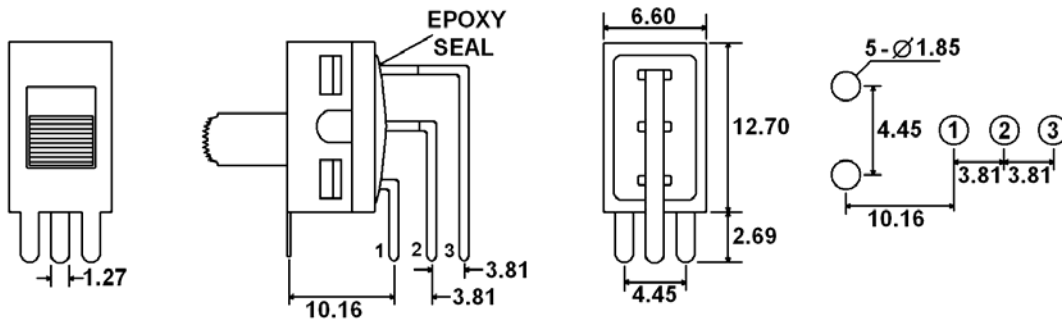

V = Vertical Mount, Right Angle PC Pins (Single Pole)

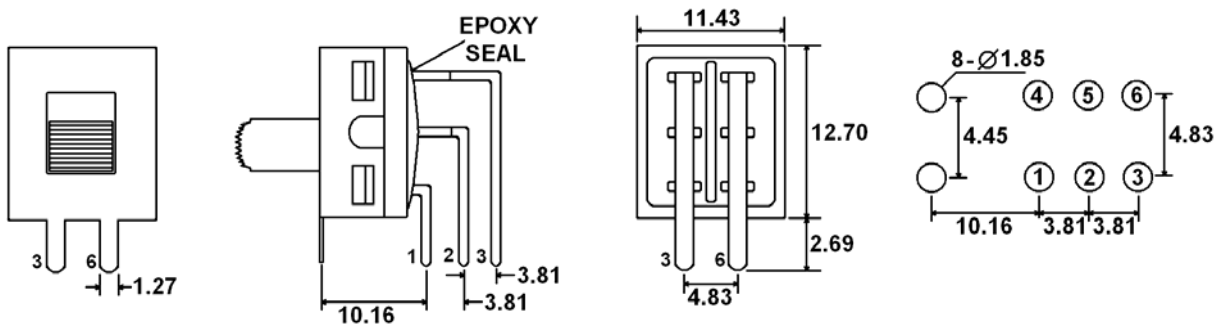

V = Vertical Mount, Right Angle PC Pins (Double Pole)

TERMINAL OPTIONS

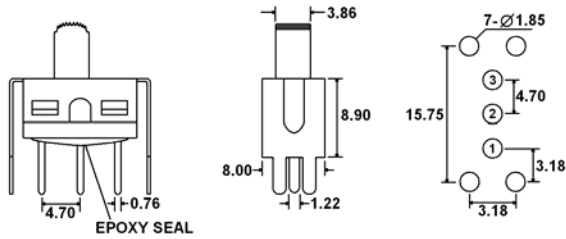

S20 = PC Pins with Support Bracket (Single Pole)

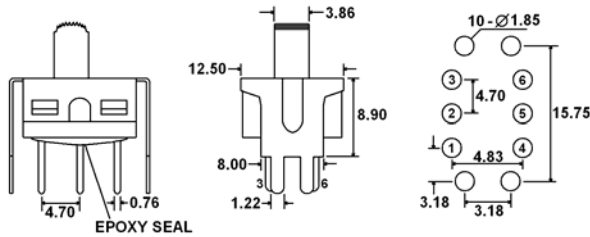

S20 = PC Pins with Support Bracket (Double Pole)

CONTACT OPTIONS

Designator	Contact Material	Terminal Material	Electrical Ratings
Q	Silver Plating	Silver Plating	5A @ 120VAC, 28VDC; 2A @ 250VAC
R	Gold over Nickel Plating	Gold over Nickel Plating	.4 VA max @ 20VAC or VAC max
G	Gold over Silver Plating	Gold over Silver Plating	.4 VA max @ 20VAC or VAC max or 5A @ 120VAC, 28VDC; 2A @ 250VAC

MOUNTING OPTIONS

<p>For A1, A2, A3, & A4 Switch Functions 1 & 2</p> <p>A = No Mounting Ears</p>	<p>For D1 Switch Functions 1 & 2</p> <p>A = No Mounting Ears</p>	<p>For A1, A2, A3, & A4 Switch Function 3</p> <p>A = No Mounting Ears</p>	<p>For D1 Switch Function 3</p> <p>A = No Mounting Ears</p>
<p>For A1, A2, A3, & A4 Switch Functions 1 & 2</p> <p>B = Mounting Ears</p>	<p>For D1 Switch Functions 1 & 2</p> <p>B = Mounting Ears</p>	<p>For A1, A2, A3, & A4 Switch Function 3</p> <p>B = Mounting Ears</p>	<p>For D1 Switch Function 3</p> <p>B = Mounting Ears</p>