

C&K E Series Sealed Miniature Toggle Switches

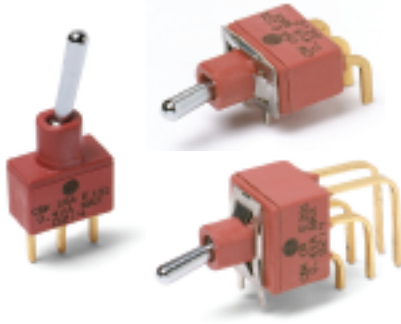

Features/Benefits

- Sealed against solder and cleaning process contaminants
- UL 94V-0 Nylon case and bushing
- Multi-positions
- ESD protection available
- RoHS compliant models available

Typical Applications

- Telecommunications
- Instrumentation
- Medical equipment



Specifications

CONTACT RATING: B contact material: 0.4 VA max. @ 20 V AC or DC max. Q contact material: E1XX & E2XX
MODELS: 7.5 AMPS @ 125 V AC or 28 V DC; 3 AMPS @ 250 V AC. E3XX MODELS: 5 AMPS @ 125 V AC or 28 V DC; 2 AMPS @ 250 V AC. See page G-25 for additional ratings.

ELECTRICAL LIFE: E1XX and E2XX models: 40,000 make-and-break cycles at full load. E3XX models: 30,000 cycles.

CONTACT RESISTANCE: Below 10 mΩ typ. initial @ 2-4 V DC, 100 mA, for both silver and gold plated contacts.

INSULATION RESISTANCE: 10⁹ Ω min.

ELECTROSTATIC DISCHARGE (ESD) OPTION: F1 conductive bushing only. Dissipates up to 20,000 V DC from actuator to ground.

DIELECTRIC STRENGTH: 1000 Vrms min. @ sea level.

OPERATING TEMPERATURE: -30°C to 85°C.

SOLDERABILITY: Per MIL-STD-202F method 208D, or EIA RS-186E method 9 (1 hour steam aging).

DEGREE OF PROTECTION: IP57; Protection against harmful dust deposit, full-scale voltage protection, temporary immersion.

Materials

CASE & BUSHING: Glass filled nylon 6/6, flame retardant, heat stabilized (UL 94V-0). F1 conductive bushing option is impregnated with carbon fibers.

ACTUATOR: Brass, chrome plated with internal o-ring seal standard.

SWITCH SUPPORT: Brass or steel, matte-tin plated.

SWITCH SUPPORT RETAINER: Stainless steel.

CONTACTS & TERMINALS: B contact material: Copper alloy, with gold plate over nickel plate. Q contact material: Copper alloy, silver plated. See page G-29 for additional contact materials.

TERMINAL SEAL: Epoxy.

HARDWARE: Nut & Locking ring: Brass, nickel plated.
 Lockwasher: Steel, nickel plated.

NOTE: Any models supplied with P, S, R, Q, B or G contact material are RoHS compliant and compatible. For the latest information regarding RoHS compliance, please go to: www.ittcannon.com/rohs.

NOTE: Specifications and materials listed above are for switches with standard options. For information on specific and custom switches, consult Customer Service Center.

Build-A-Switch

To order, simply select desired option from each category and place in the appropriate box. Available options are shown and described on pages G-23 thru G-29. For additional options not shown in catalog, consult our Customer Service Center. All models are process sealed to withstand machine soldering temperatures and pressure wash cleaning methods.

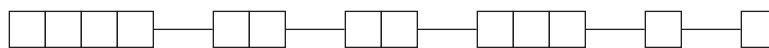

Switch Function

- E101** SP, On-None-On
- E103** SP, On-Off-On
- E105** SP, Mom.-Off-Mom.
- E107** SP, On-Off-Mom.
- E108** SP, On-None-Mom.
- E201** DP, On-None-On
- E203** DP, On-Off-On
- E205** DP, Mom.-Off-Mom.
- E207** DP, On-Off-Mom.
- E208** DP, On-None-Mom.
- E211** DP, On-On-On
- E213** DP, On-On-Mom.
- E215** DP, Mom.-On-Mom.
- E301** 3P, On-None-On

Actuator

- M** .300" high
- S** .500" high
- L3** Plastic, .940" high

Bushing

- D1** .250" high
- F1** Conductive, .250" high*
- D9** .280" high
- Y** Threaded, .350" high

Terminations

- A** Right angle, PC thru-hole
- AV2** Vertical right angle, PC thru-hole
- C** PC Thru-hole
- V3** .460" high, V-bracket
- Z** Solder lug
- A3** Right angle, PC thru-hole
- AV3** Vertical right angle, PC thru-hole
- V6** .460" high, V-bracket
- V9** 1.150" high, V-bracket
- V31** .460" high, snap-in V-bracket
- V61** .460" high, snap-in V-bracket
- W** .750" long, wire wrap
- Z3** Quick connect

Contact Material

- B** Gold
- K** Gold, tin-lead
- P** Gold, matte-tin
- Q** Silver
- M** Silver, tin-lead
- S** Silver, matte-tin
- G** Gold over silver
- L** Gold over silver, tin-lead
- R** Gold over silver, matte-tin

Seal

- E** Epoxy

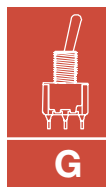

Toggle

* F1 available with SP and DP versions only, please see page G-24



Dimensions are shown: Inch (mm)
 Specifications and dimensions subject to change

C&K E Series Sealed Miniature Toggle Switches

SWITCH FUNCTION

NO. POLES	MODEL NO.	SWITCH FUNCTION			CONNECTED TERMINALS			SCHEMATIC
		POS. 1	POS. 2	POS. 3	POS. 1	POS. 2	POS. 3	
		C&K marking on opposite side			C&K marking on opposite side			
SP	E101	ON	NONE	ON	2-3	N/A	2-1	
	E103	ON	OFF	ON	2-3	OPEN	2-1	
	E105	MOM.	OFF	MOM.				
	E107	ON	OFF	MOM.				
	E108	ON	NONE	MOM.	2-3	N/A	2-1	

SPDT

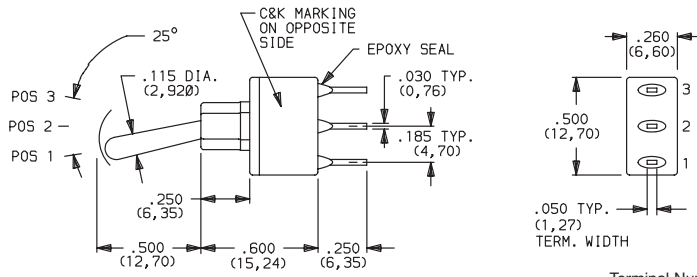

Part number shown: E101SD1CBE

Terminal Numbers
For Reference Only

DP	E201	ON	NONE	ON	2-3,5-6	N/A	2-1,5-4	
	E203	ON	OFF	ON	2-3,5-6	OPEN	2-1,5-4	
	E205	MOM.	OFF	MOM.				
	E207	ON	OFF	MOM.				
	E208	ON	NONE	MOM.	2-3,5-6	N/A	2-1,5-4	
	E211 **	ON	ON	ON	2-3,5-6	2-3,5-4	2-1,5-4	
	E213**	ON	ON	MOM.				
	E215**	MOM.	ON	MOM.				

DPDT

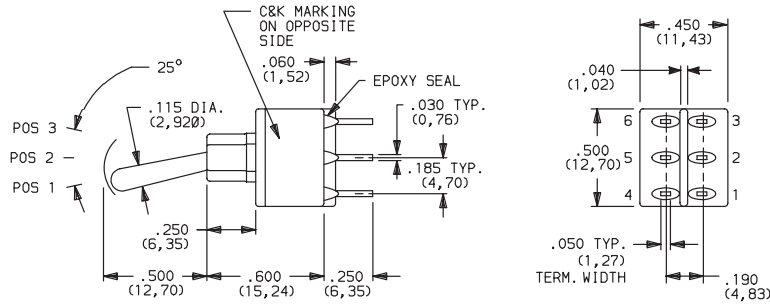

Part number shown: E201SD1CBE

Terminal Numbers
For Reference Only

MOM. = Momentary

** Wiring for 3-way switch, see Section O.

All models with all options when ordered with G, L, R, M, Q or S contact material except with F1 conductive bushing.

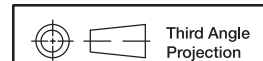

Dimensions are shown: Inch (mm)
Specifications and dimensions subject to change



Toggle

C&K E Series Sealed Miniature Toggle Switches

SWITCH FUNCTION

NO. POLES	MODEL NO.	SWITCH FUNCTION			CONNECTED TERMINALS			SCHEMATIC
		POS. 1	POS. 2	POS. 3	POS. 1	POS. 2	POS. 3	
3P	E301	ON	NONE	ON	2-3,5-6,8-9	N/A	2-1,5-4,8-7	

3PDT

Terminal Nos.
For Reference Only

Part number shown: E301SD1CBE

MOM. = Momentary

** Wiring for 3-way switch, see Section O.

All models with all options when ordered with G, L, R, M, Q or S contact material except with F1 conductive bushing.

ACTUATOR

M .300" HIGH

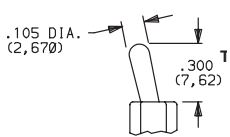

Standard when ordered with A, A3, AV2, AV3, V2-V61 terminations. Finish: Chrome.

S .500" HIGH

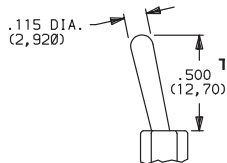

Standard when ordered with C, Z, Z3, W & W4 terminations. Finish: Chrome

L3 PLASTIC, .940" HIGH

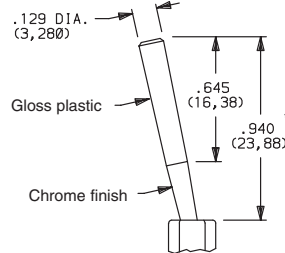

OPTION CODE	L3 ACTUATOR COLOR
2	BLACK

Other colors available, consult Customer Service Center. No color choice required for S & M actuators.

* Actuators shown with standard D1 bushing. Subtract .030 (0,76) for D9 bushing. Subtract .100 (2,54) for Y bushing.

BUSHING

D1 .250" HIGH, UNTHREADED

F1 ESD CONDUCTIVE BUSHING, .250" HIGH, UNTHREADED

F1 bushing is not UL/CSA approved

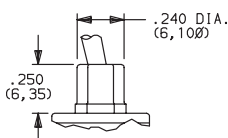
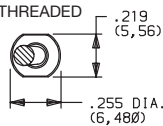

D9 .280" HIGH, UNTHREADED

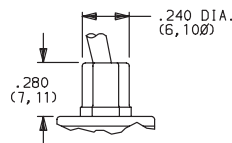
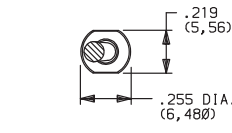

E3XX models not available with D9 bushing.

Y THREADED, INSULATED, .350" HIGH WITH KEYWAY

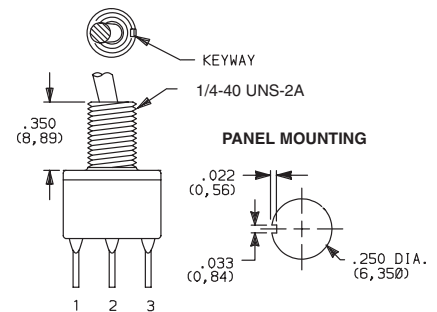

Available only with C, Z, Z3, & W terminations. Hardware: One dress nut part number 780701201, one hex nut part number 540400201 and lockwasher part number 700303202 supplied standard.

Will withstand 4 in.-lbs. of torque with no distortion.

NOTE: Internal o-ring actuator seal standard for all bushing options.



Dimensions are shown: Inch (mm)
Specifications and dimensions subject to change



C&K E Series Sealed Miniature Toggle Switches

TERMINATIONS

Z SOLDER LUG

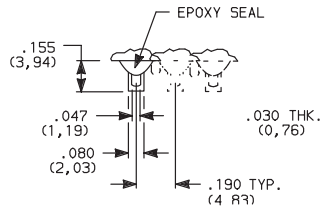

SPDT thru 3PDT

Not available with F1 conductive bushing or K, L or M contact material.

C PC THRU-HOLE

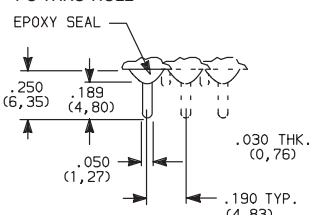

SPDT thru 3PDT

Not available with F1 conductive bushing.

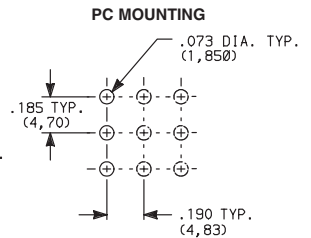

Z3 QUICK CONNECT

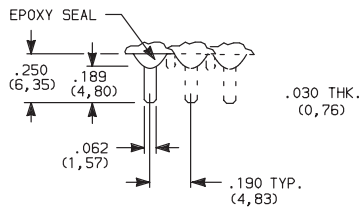

SPDT thru 3PDT

Not available with F1 conductive bushing or K, L or M contact material. Mating quick connector available; order part number 530100000, page G-26.

A RIGHT ANGLE, PC THRU-HOLE

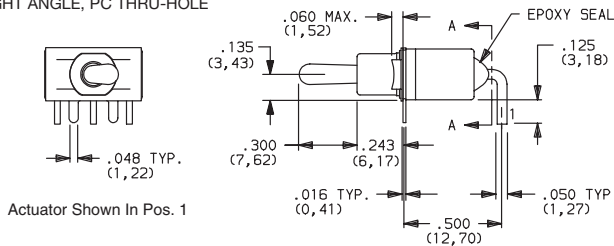

Actuator Shown In Pos. 1

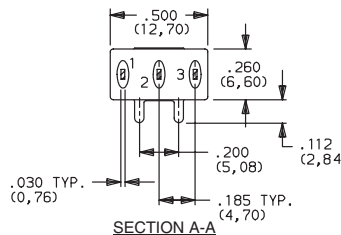

SECTION A-A

Terminal Nos. For Reference Only

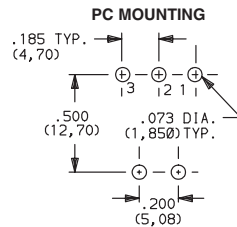

E101MD1ABE
Horizontal Actuation
SPDT

A3 RIGHT ANGLE, SNAP-IN, PC THRU-HOLE

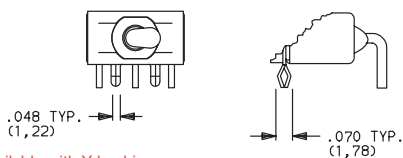

Not available with Y bushing.
Terminal bend radii and lead-in manufacturing option.

A RIGHT ANGLE, PC THRU-HOLE

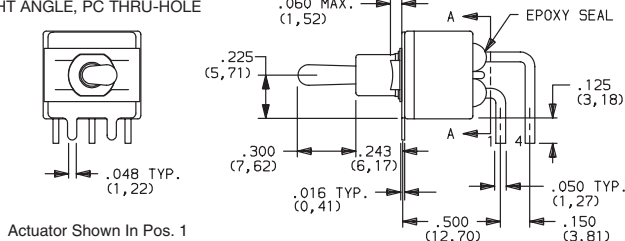

Actuator Shown In Pos. 1

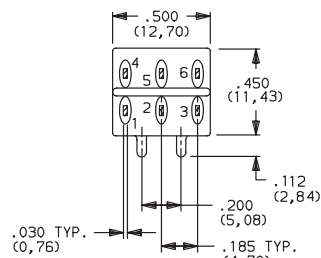

SECTION A-A

Terminal Nos. For Reference Only

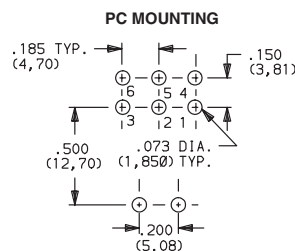

E201MD1ABE
Horizontal Actuation
DPDT

A3 RIGHT ANGLE, SNAP-IN, PC THRU-HOLE

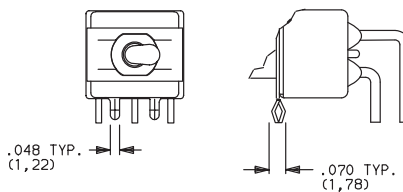

Not available with Y bushing.
Terminal bend radii and lead-in manufacturing option.



Third Angle Projection

Dimensions are shown: Inch (mm)
Specifications and dimensions subject to change



G

Toggle

C&K E Series Sealed Miniature Toggle Switches

TERMINATIONS

A RIGHT ANGLE, PC THRU-HOLE

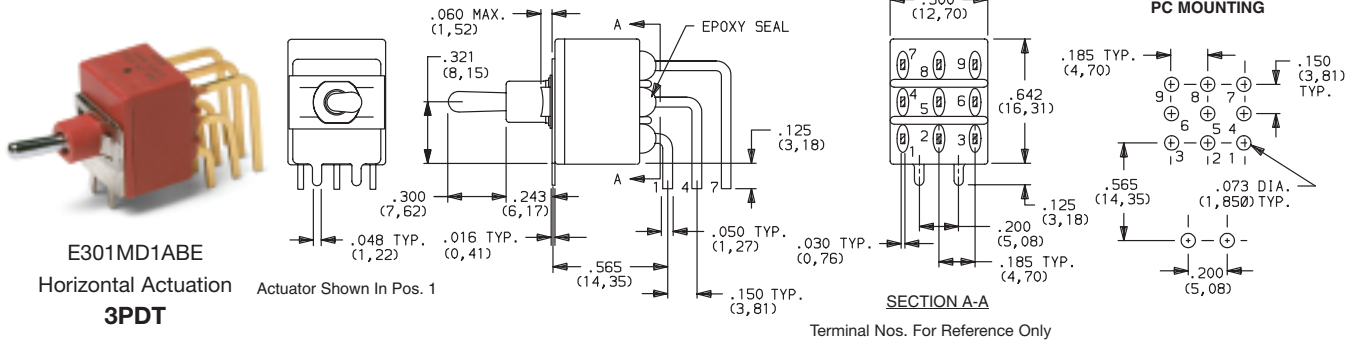

Not available with D9 & Y bushings.
Terminal bend radii and lead-in manufacturing option.

AV2 VERTICAL RIGHT ANGLE, PC THRU-HOLE, .150" PITCH

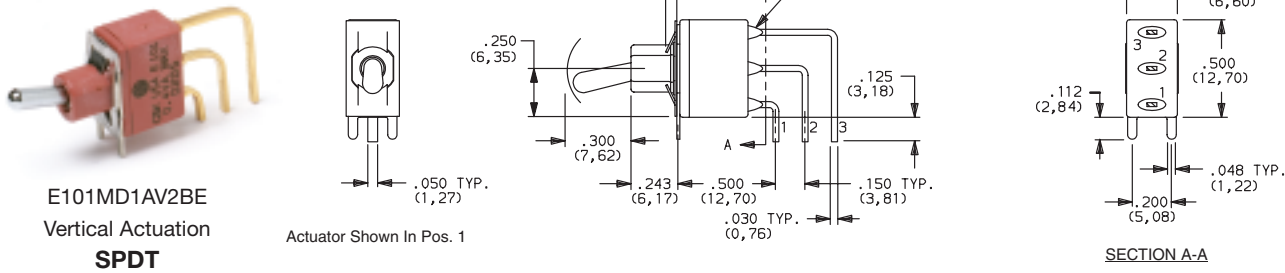

AV3 VERTICAL RIGHT ANGLE, SNAP-IN, PC THRU-HOLE, .150" PITCH

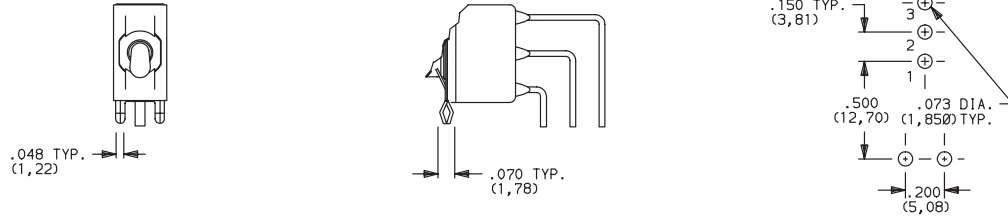

Not available with Y bushing.
Terminal bend radii and lead-in manufacturing option.

AV2 VERTICAL RIGHT ANGLE, PC THRU-HOLE, .150" PITCH

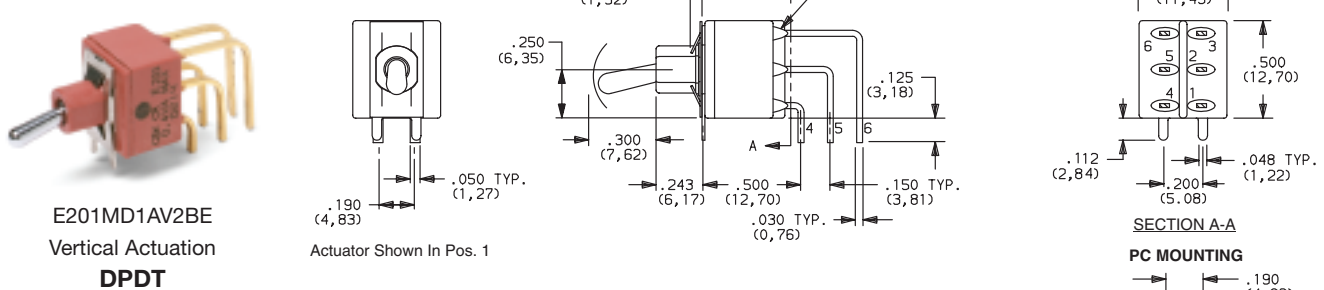

A3 VERTICAL RIGHT ANGLE, SNAP-IN, PC THRU-HOLE, .150" PITCH

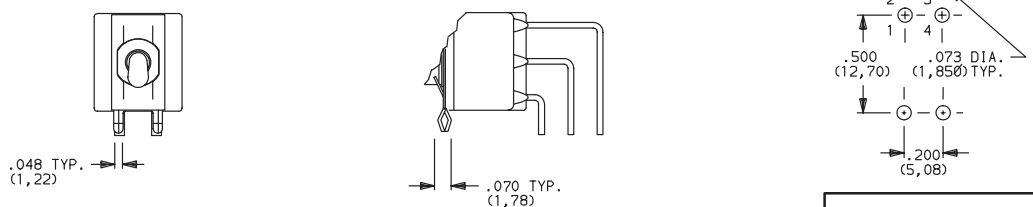

Not available with Y bushing.
Terminal bend radii and lead-in manufacturing option.



Dimensions are shown: Inch (mm)
Specifications and dimensions subject to change

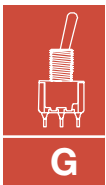

Toggle



C&K E Series Sealed Miniature Toggle Switches

TERMINATIONS

AV2 VERTICAL RIGHT ANGLE, PC THRU-HOLE,
.150" PITCH

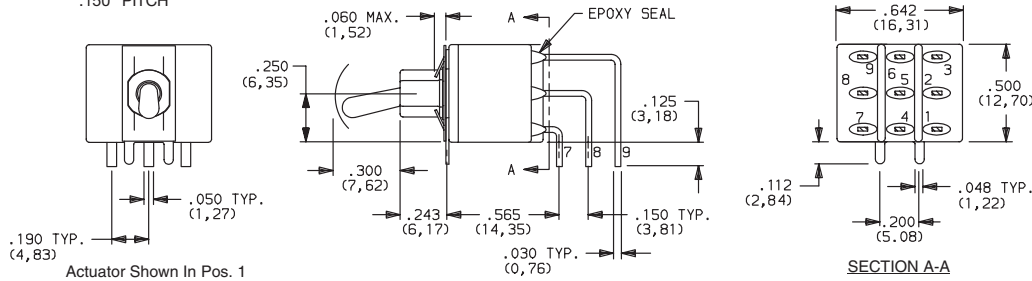

E301MD1AV2BE
Vertical Actuation
3PDT

AV3 VERTICAL RIGHT ANGLE, SNAP-IN, PC THRU-HOLE
.150" PITCH

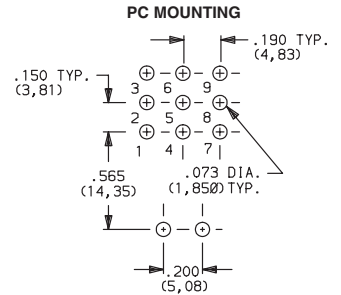

Not available with D9 & Y bushings.
Terminal bend radii and lead-in manufacturing option.

V6 VERTICAL MOUNT, V-BRACKET

V61 VERTICAL MOUNT, V-BRACKET, SNAP-IN

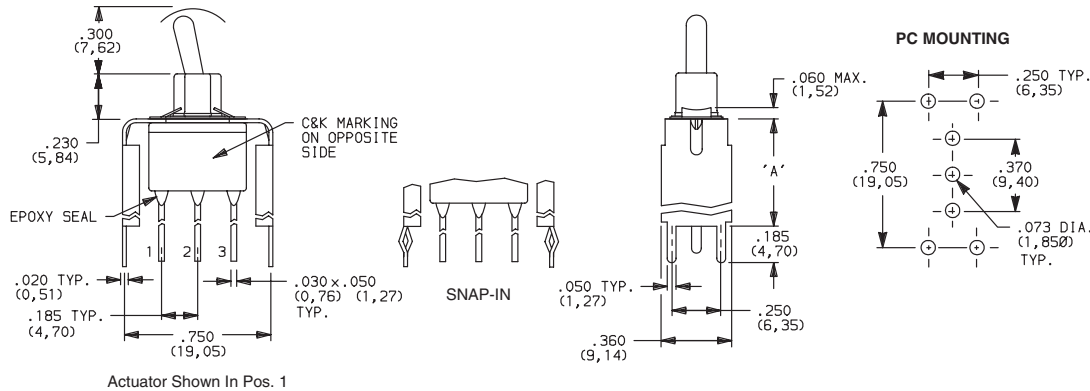

E101MD1_BE
SPDT

OPTION CODE	DIM 'A'
V6, V61	.460 (11,68)

Not available with Y bushing.

V6 VERTICAL MOUNT, V-BRACKET

V61 VERTICAL MOUNT, V-BRACKET, SNAP-IN

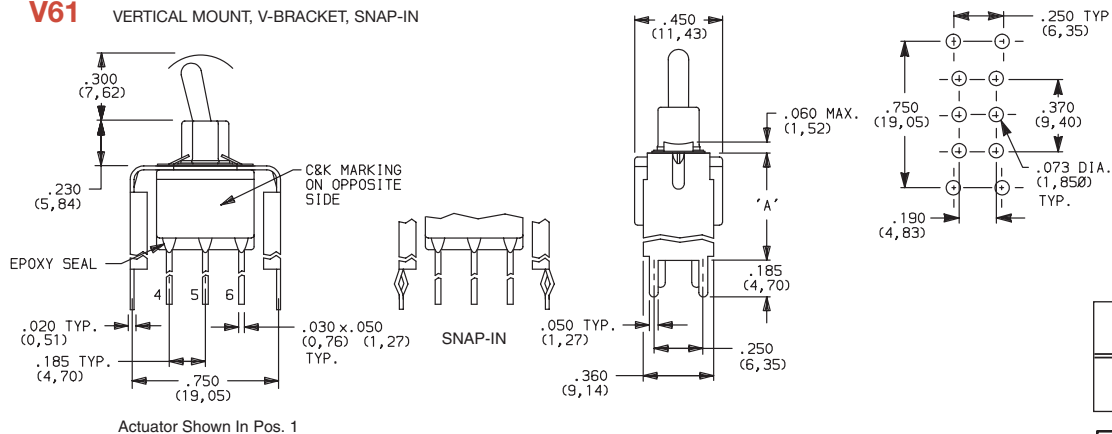

E201MD1_BE
DPDT

OPTION CODE	DIM 'A'
V6, V61	.460 (11,68)

Not available with Y bushing.



Dimensions are shown: Inch (mm)
Specifications and dimensions subject to change



G

Toggle

C&K E Series Sealed Miniature Toggle Switches

TERMINATIONS

V3, V9 VERTICAL MOUNT, V-BRACKET

V31 VERTICAL MOUNT, V-BRACKET, SNAP-IN



E101MD1_BE
SPDT

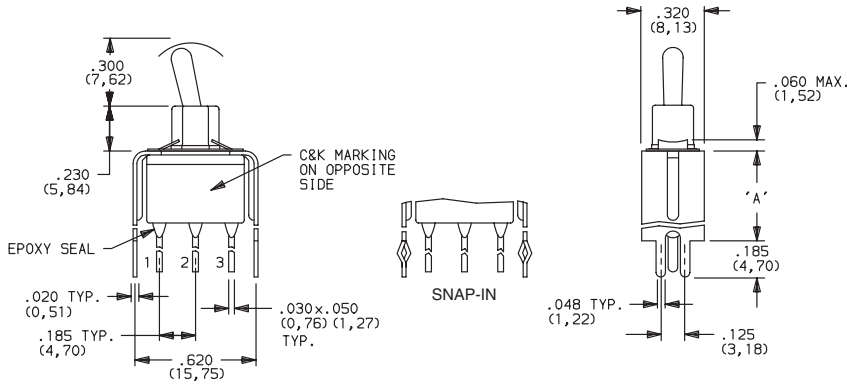

Actuator Shown In Pos. 1

Not available with Y bushing.

PC MOUNTING

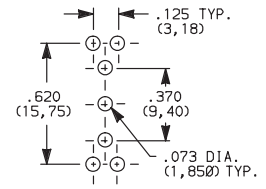

OPTION CODE	DIM 'A'
V3, V31	.460 (11,68)
V9	1.150 (29,21)

V3, V9 VERTICAL MOUNT, V-BRACKET

V31 VERTICAL MOUNT, V-BRACKET, SNAP-IN



E201MD1_BE
DPDT

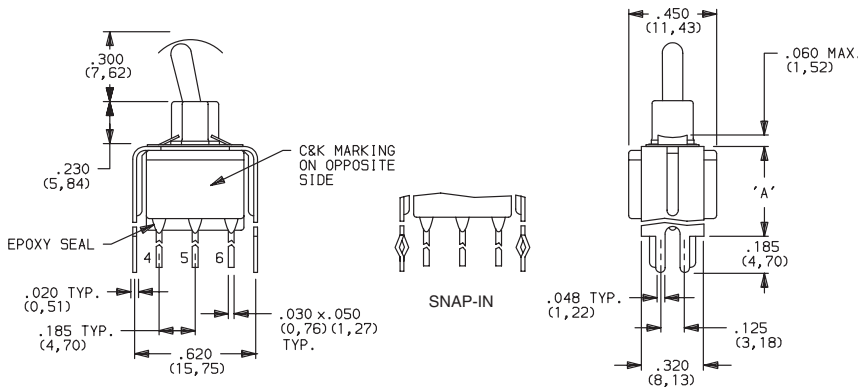

Actuator Shown In Pos. 1

Not available with Y bushing.

PC MOUNTING

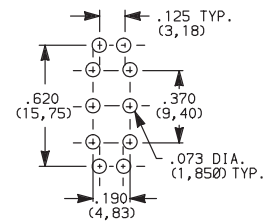

OPTION CODE	DIM 'A'
V3, V31	.460 (11,68)
V9	1.150 (29,21)

V9 VERTICAL MOUNT, V-BRACKET



E301MD1_BE
3PDT

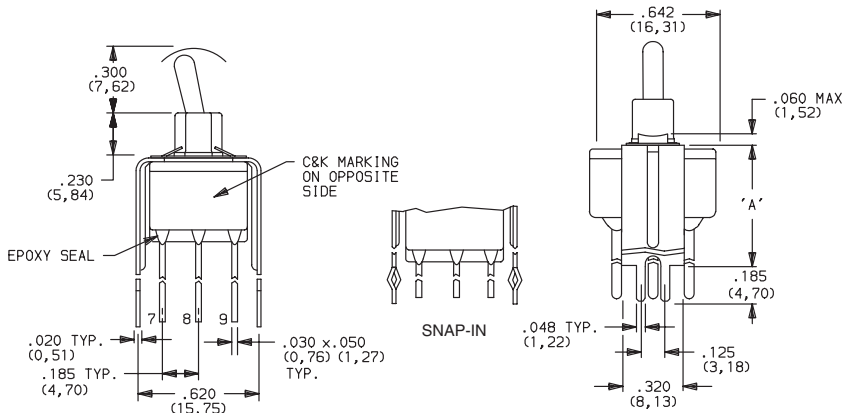

Actuator Shown In Pos. 1

Not available with D9 & Y bushings.

PC MOUNTING

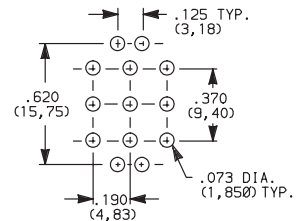

OPTION CODE	DIM 'A'
V9	1.150 (29,21)

Toggle

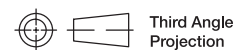

Third Angle Projection
Dimensions are shown: Inch (mm)
Specifications and dimensions subject to change

C&K E Series Sealed Miniature Toggle Switches

CONTACT MATERIAL

OPTION CODE	RoHS COMPLIANT	RoHS COMPATIBLE	CONTACT MATERIAL	TERMINAL PLATING	RATINGS	
B	YES	YES	GOLD ¹	GOLD ¹	LOW LEVEL/ DRY CIRCUIT	0.4 VA MAX. @ 20 V AC OR DC MAX.
K	NO	YES		TIN-LEAD ⁶		
P	YES	YES		MATTE-TIN ⁷		
Q	YES	YES	SILVER ^{4,5}	SILVER ⁵	POWER	E1XX & E2XX MODELS: 7.5 AMPS @ 125 V AC OR 28 V DC; 3 AMPS @ 250 V AC. E3XX MODELS: 5 AMPS @ 125 V AC OR 28 V DC; 2 AMPS @ 250 V AC.
M	NO	YES		TIN-LEAD ⁶		
S	YES	YES		MATTE-TIN ⁷		
G	YES	YES	GOLD OVER SILVER ^{2,3}	GOLD ³	LOW LEVEL/DRY CIRCUIT OR POWER	E1XX AND E2XX MODELS: 0.4 VA MAX @20 V AC OR DC MAX. OR 7.5 AMPS @125 V AC OR 28 V DC; 3 AMPS @ 250 V AC. DC E3XX MODELS: 0.4 VA MAX. @ 20 V AC OR DC MAX. OR 5 AMPS @ 125 V AC OR 28 V DC; 2 AMPS @ 250 V AC.
L	NO	YES		TIN-LEAD ⁶		
R	YES	YES		MATTE-TIN ⁷		

* Note: See Technical Data section of this catalog for RoHS compliant and compatible definitions and specifications.

¹ CONTACTS & TERMINALS: Copper alloy, with gold plate over nickel plate.

² END CONTACTS: Coin silver, with gold plate over nickel plate.

³ CENTER CONTACTS & ALL TERMINALS: Copper alloy, with gold plate over nickel plate.



⁴ END CONTACTS: Coin silver, silver plated.

⁵ CENTER CONTACT & ALL TERMINALS: Copper alloy, with gold flash over silver plate. Or copper alloy, silver plated.

⁶ TERMINALS: Copper alloy, with tin-lead alloy over nickel plate.

⁷ TERMINALS: Copper alloy, with matte-tin over nickel plate.

NOTE: Any models supplied with P, S, R, Q, B or G contact material are RoHS compliant. For the latest information regarding RoHS compliance, please go to: www.ittcannon.com/rohs.

All models   with all options when ordered with S, R, G, L, M or Q contact material except with F1 conductive bushing.

B contact material standard with all terminations.

P, S, R, K, L & M contact materials not available with Z & Z3 terminations.

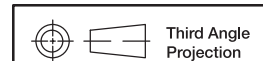

Dimensions are shown: Inch (mm)

Specifications and dimensions subject to change

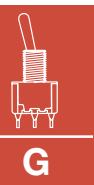

G

Toggle