



SERIES: EMSA 30W

DESCRIPTION: SWITCHING POWER SUPPLY

FEATURES

- universal AC input
- regulated output voltage
- short circuit protection
- meets EISA / efficiency level V regulations
- custom designs available



MODEL	output voltage		output current		output wattage	ripple*	efficiency level	cord length (mm)
	nominal (V dc)		min (A)	max (A)	max (W)	max. (mVp-p)		
EMSA120250	12		0	2.5	30	300	V	1530 ±100
EMSA200150	20		0	1.5	30	300	V	1530 ±100
EMSA240125	24		0	1.25	30	300	V	1530 ±100

*at full load, 100 ~ 240 V ac input, measured at 20MHz bandwidth with a 10 uF electrolytic cap and a 0.1 uF ceramic cap on the output

PART NUMBER KEY

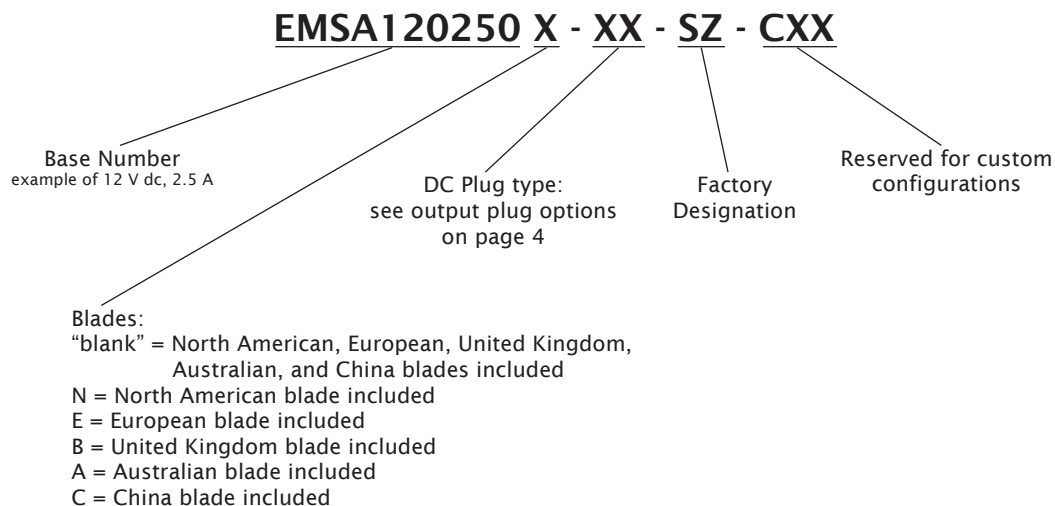



SERIES: EMSA 30W

DESCRIPTION: SWITCHING POWER SUPPLY

INPUT

parameter	conditions/description	min	nom	max	units
rated input voltage		100		240	V ac
input voltage range		90		264	V ac
rated frequency		50		60	Hz
frequency range		47		63	Hz
rated input current				1.0	A
no load power consumption				0.3	W

OUTPUT

parameter	conditions/description	min	nom	max	units
line regulation			±1		%
load regulation			±5		%
over voltage protection	output voltage clamped by internal protection zener				
short circuit protection	output shut down and auto-restart				

SAFETY & EMI

parameter	conditions/description	min	nom	max	units
HI-POT	input to output at 10 mA for 1 minute			3,000 4,242	V ac V dc
insulation resistance	input to output at 500 V dc	100			MΩ
safety approvals	UL/cUL, GS, BSMI, RCM, CCC				
EMI standard	FCC class B, CE, VCCI-II				
leakage current				0.25	mA
RoHS compliant	yes				

ENVIRONMENTAL

parameter	conditions/description	min	nom	max	units
operating temperature		0		40	°C
operating humidity		20		80	%
storage temperature		-10		70	°C
storage humidity		10		90	%



SERIES: EMSA 30W

DESCRIPTION: SWITCHING POWER SUPPLY

MECHANICAL DRAWING

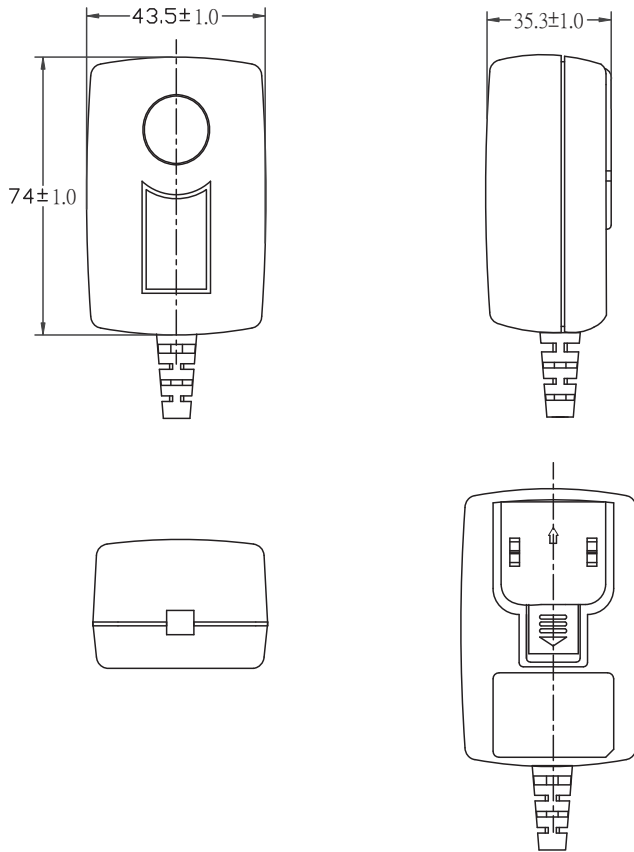

input plug	multi-blade (UL, UK, VDE, SAA, CCC)
weight	230 g (12 V), 220 g (20/24 V)
case size	74 L x 43.5 W x 35.3 H mm tolerance: ±1 mm



EMS-US

EMS-AU

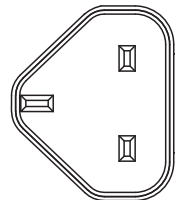

EMS-UK

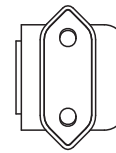

EMS-EU

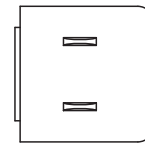

EMS-CC

DC CORD

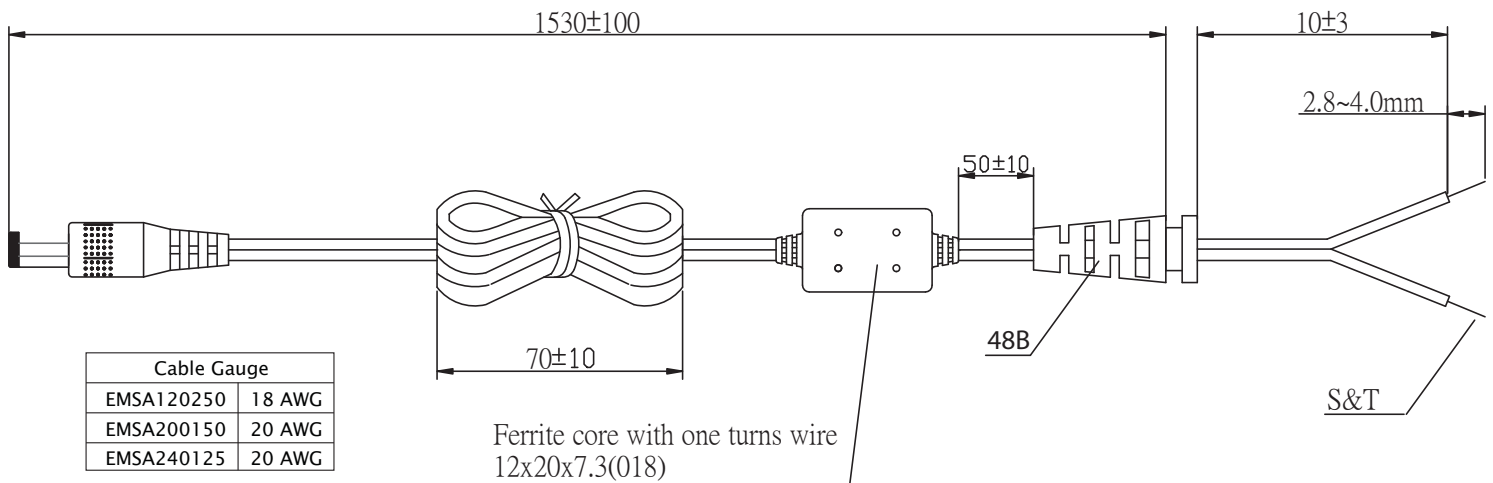

Black wire, white stripe: Positive



SERIES: EMSA 30W

DESCRIPTION: SWITCHING POWER SUPPLY

OUTPUT PLUG OPTIONS

3.5 mm Phono Plug

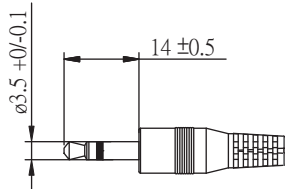

P1

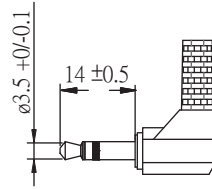

P1R

*Tip positive

Standard DC Plug

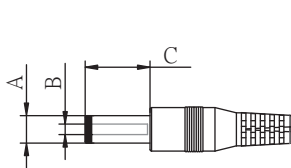

Standard PX

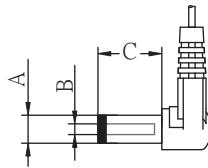

Right Angle PXR

	A	B	C	Unit
P5/P5R	5.5	2.1	9.5	mm
P6/P6R	5.5	2.5	9.5	mm
P7/P7R	3.5	1.3	9.5	mm
P8/P8R	3.8	1.35	9.5	mm
P9/P9R	3.8	1.05	9.5	mm

Locking DC Plug

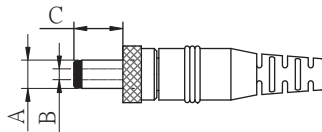

	A	B	C	Unit
P10	5.5	2.1	9.5	mm
P11	5.5	2.5	9.5	mm

EIAJ Plugs

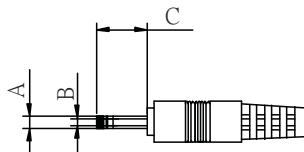

Standard PXX

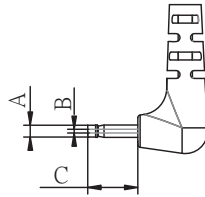

Right Angle PXXR

	EIAJ	A	B	C	D	Unit
P12/P12R	EIAJ-1	2.35	0.7	9.5	NA	mm
P13/P13R	EIAJ-2	4.0	1.7	9.5	5.0	mm
P14/P14R	EIAJ-3	4.75	1.7	9.5	5.0	mm

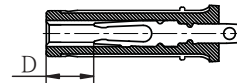

Stripped and Tinned

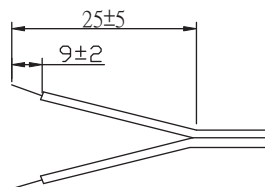

DC PLUG TYPE

ST
stripped and tinned

PXX X X

Plug type Plug angle: "blank" = standard
R = right angle Plug polarity: "blank" = N/A
P = center positive N = center negative

⊖ ⊕ ⊕ ⊕ ⊖ ⊖

*Contact CUI for additional output plug options.



SERIES: EMSA 30W

DESCRIPTION: SWITCHING POWER SUPPLY

INDIVIDUAL PACKAGING

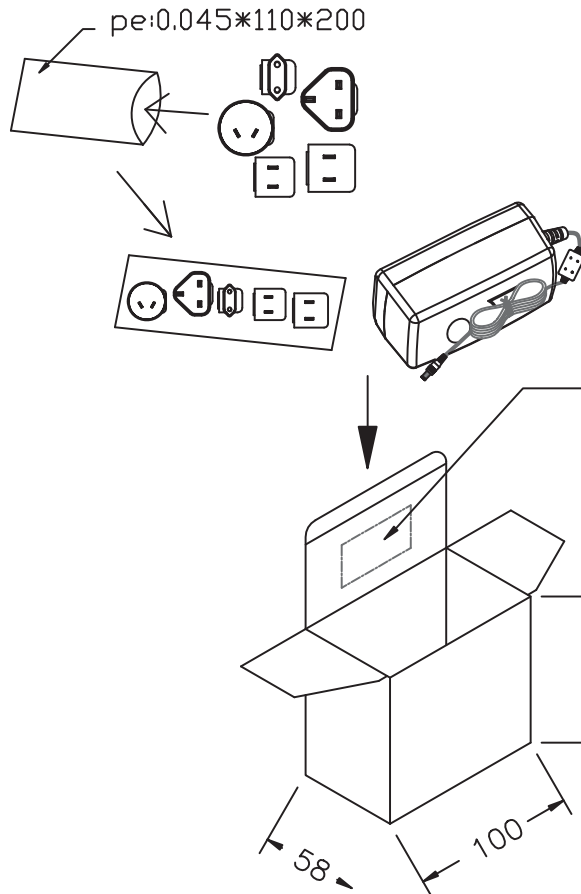

tolerance ± 1 mm



PACKAGING

EXTERNAL CARTON MATERIAL:A=B(6mm)

INTERNAL CARTON MATERIAL:B3B(3mm)

CARTON SIZE: 485X428X210mm

Q'TY: 60pcs(20x3x1)

"RoHS Compliant"

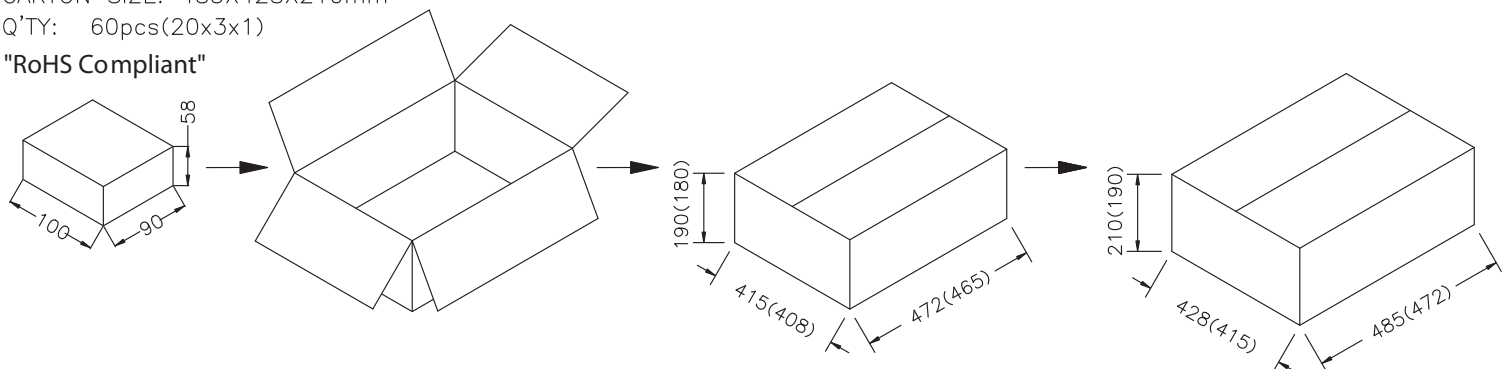

tolerance +7 / -0 mm