



**JEWEL HILL ELECTRONIC CO.,LTD.**

**SPECIFICATIONS FOR  
LCD MODULE**

**Module No. GB160160A**

Office Address: Rm. 518,5/F., 101 Shangbu Industrial District,  
HuaqiangNorthRoad, Shenzhen, China

TEL : (86)-755-83362489 83617492

FAX: (86)-755-83286396 83365871

E-mail: [sales@jhlcd.com](mailto:sales@jhlcd.com)

[jhlcd@21cn.com](mailto:jhlcd@21cn.com)

Website: [www.jhlcd.com](http://www.jhlcd.com)

## **TABLE OF CONTENTS**

|  |           |
|--|-----------|
| <b>LCM NUMBER SYSTEM .....</b>                     | <b>2</b>  |
| <b>1. GENERAL DESCRIPTION .....</b>                | <b>3</b>  |
| <b>2. FEATURES.....</b>                            | <b>3</b>  |
| <b>3. MECHANICAL SPECIFICATION .....</b>           | <b>3</b>  |
| <b>4. MECHANICAL DIMENSION .....</b>               | <b>4</b>  |
| <b>5. MAXIMUM RATINGS .....</b>                    | <b>5</b>  |
| <b>6. ELECTRICAL CHARACTERISTICS .....</b>         | <b>5</b>  |
| <b>7. MODULE FUNCTION DESCRIPTION .....</b>        | <b>6</b>  |
| <b>8. ELECTRO-OPTICAL CHARACTERISTICS .....</b>    | <b>14</b> |
| <b>9. RELIABILITY.....</b>                         | <b>18</b> |
| <b>10. PRECAUTIONS FOR USING LCD MODULES .....</b> | <b>19</b> |
| <b>11. USING LCD MODULES.....</b>                  | <b>21</b> |
| <b>12. REVISION HISTORY .....</b>                  | <b>23</b> |
| <b>SAMPLE APPROVED REPORT .....</b>                | <b>24</b> |

## LCM Number System

GB 160160 A S Y C Y N D A - V00

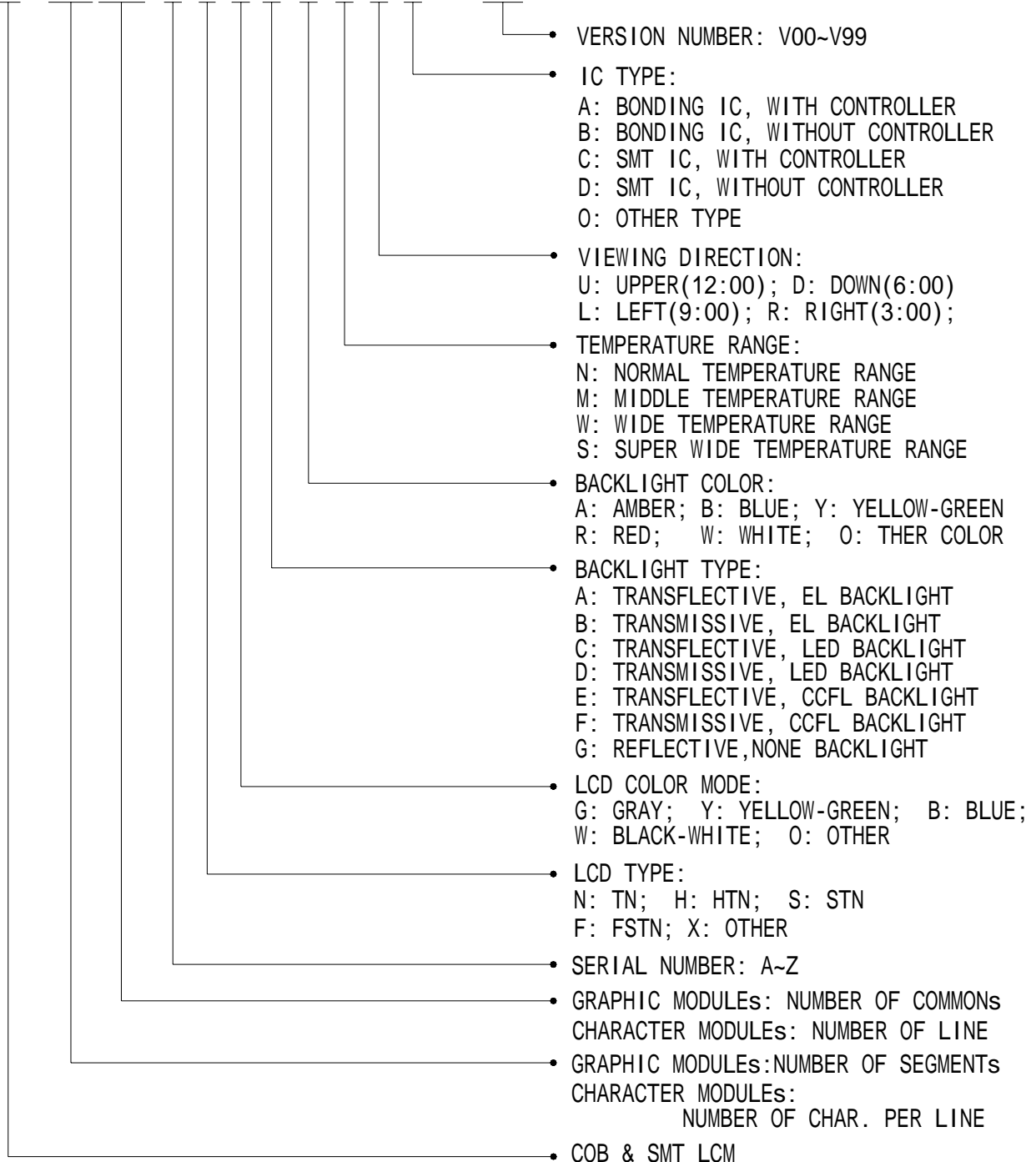

## 1. GENERAL DESCRIPTION

The GB160160A is a 160 x 160 Dots Graphics LCD module. It has a STN panel composed of 160segments and 160 commons. The LCM can be easily accessed by micro-controller via parallel interface.

## 2. FEATURES

|                    |                              |
|--------------------|------------------------------|
| Display Mode       | Transflective and Positive   |
|                    | STN(Y-G) module              |
| Display Format     | Graphic 160 x 160 dots       |
| Input Data         | Parallel data input from MPU |
| Multiplexing Ratio | 1/160 Duty                   |
| Bias               | 1/12 Bias                    |
| Viewing Direction  | 6 O'clock                    |
| Backlight          | LED (Yellow-Green)           |

## 3. MECHANICAL SPECIFICATION

| Item                | Specifications          | Unit |
|---------------------|-------------------------|------|
| Dimensional outline | 88.8 x 88.8 x 14.5(max) | mm   |
| Resolution          | 160segs x 160coms       | dots |
| Active area         | 60.775(W) x 60.775(H)   | mm   |
| Dots pitch          | 0.38(W)×0.38(H)         | mm   |
| Dots size           | 0.355(W)×0.355 (H)      | mm   |

## 4. MECHANICAL DIMENSION

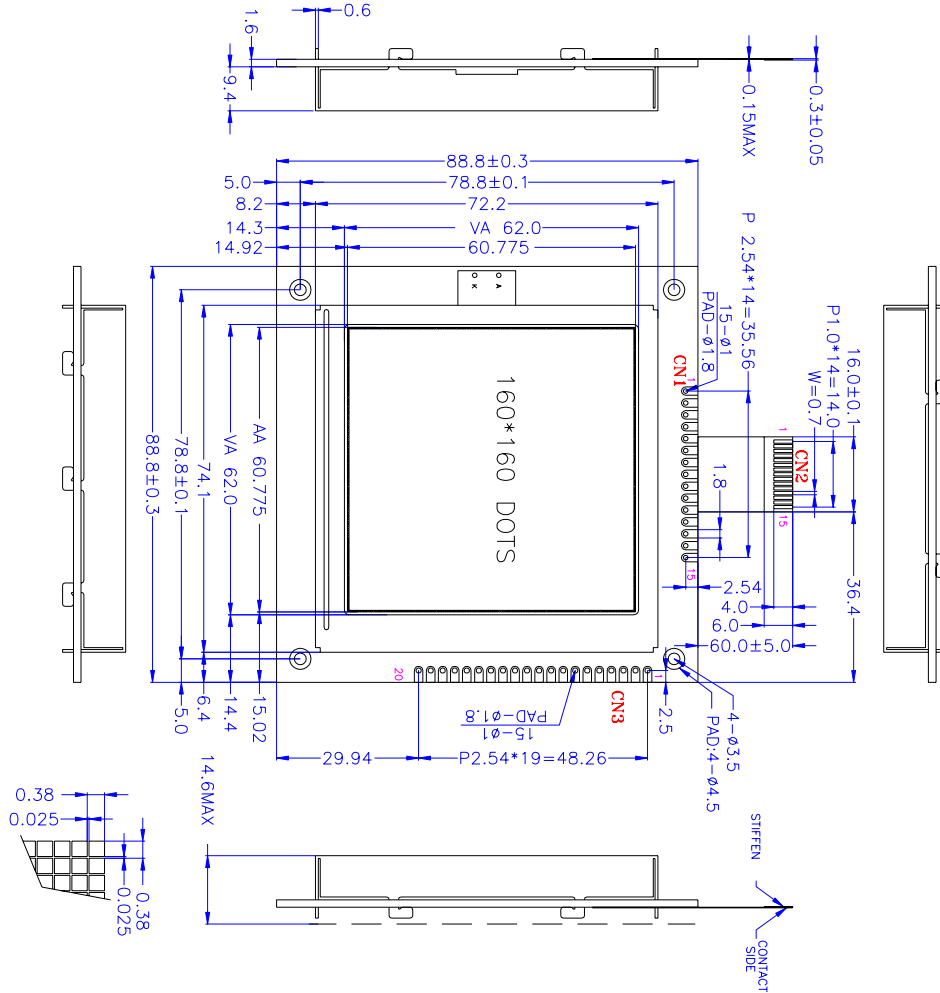

**CN1 & CN2**

| NO. | SYMBOL |
|-----|--------|
| 1   | VSS    |
| 2   | M      |
| 3   | FLM    |
| 4   | CL1    |
| 5   | CL2    |
| 6   | D3     |
| 7   | D2     |
| 8   | D1     |
| 9   | D0     |
| 10  | VEE    |
| 11  | VDD    |
| 12  | V0     |
| 13  | /DISP  |
| 14  | K      |
| 15  | A      |

**CN3:**

| NO. | SYMBOL |
|-----|--------|
| 1   | VSS    |
| 2   | VDD    |
| 3   | V0     |
| 4   | /RD    |
| 5   | /RW    |
| 6   | /CE    |
| 7   | C/D    |
| 8   | DB0    |
| 9   | DB1    |
| 10  | DB2    |
| 11  | DB3    |
| 12  | DB4    |
| 13  | DB5    |
| 14  | DB6    |
| 15  | DB7    |
| 16  | /RES   |
| 17  | VOUT   |
| 18  | LEDA   |
| 19  | LEDK   |
| 20  | NC     |

## 5. MAXIMUM RATINGS

| Item                  | Symbol            | Min  | Max          | Unit | Note |
|-----------------------|-------------------|------|--------------|------|------|
| Supply voltage        | $V_{DD} - V_{SS}$ | -0.3 | 5.5          | V    |      |
|                       | $V_{LCD}$         | -0.3 | 24.0         | V    |      |
| Input Voltage         | $V_{IN}$          | -0.3 | $V_{DD}+0.3$ | V    |      |
| Operating temperature | $T_{OPR}$         | 0    | +50          | °C   |      |
| Storage temperature   | $T_{STR}$         | -10  | +60          | °C   |      |
| Humidity              | ---               | ---  | 90           | %RH  |      |

## 6. ELECTRICAL CHARACTERISTICS

| Item                                     |         | Symbol    | Condition  | Min.        | Typ. | Max.        | Unit |
|--|---------|-----------|--|-------------|------|-------------|------|
| Supply Voltage                           | Logic   | $V_{DD}$  | ---  | ---         | 5.0  | ---         | V    |
| Input Voltage                            | H level | $V_{IH}$  | ---  | $0.8V_{DD}$ | ---  | $V_{DD}$    | V    |
|  | L level | $V_{IL}$  |  | $V_{SS}$    | ---  | $0.2V_{DD}$ |      |
| Current Consumption (LCD DRIVER)         |         | $I_{DD}$  | $V_{DD}=5.0V;$<br>$V_{LCD}=22.2V,$<br>$T_{amb}=25^{\circ}C;$ | ---         | ---  | 1.5         | mA   |
| LCD Driving Voltage                      |         | $V_{LCD}$ | Bias=1/12<br>$V_{LCD}=V_{DD}-V_5$                            | 17.0        | 17.5 | 18.0        | V    |
| Current Consumption (With LED BackLight) |         | $I_{LED}$ | $V_{DD}=5.0V;$<br>$V_{LED}=4.2V, T_{amb}=25^{\circ}C;$       | ---         | ---  | TBD         | mA   |

## 7. MODULE FUNCTION DESCRIPTION

### 7.1. PIN DESCRIPTION

INTERFACE WITH CN1 & CN2:

| Pin No. | Symbol   | Description                                 |
|---------|----------|---|
| 1       | VSS      | Power supply for Ground (0V)                |
| 2       | M        | AC Signal for LCD Driver Output             |
| 3       | FLM      | Data Input for Common ICs                   |
| 4       | CL1      | Data Latch Colok                            |
| 5       | CL2      | Data Shift Colok                            |
| 6       | D3       | Display Data Input Terminal for Segment ICs |
| 7       | D2       |   |
| 8       | D1       |   |
| 9       | D0       |   |
| 10      | VEE      | Power Supply for Negative Voltage           |
| 11      | VDD      | Power supply for positive (+5V)             |
| 12      | V0       | VLCD Voltage Regulation Terminal            |
| 13      | /DISPOFF | Display OFF Control                         |
| 14      | K        | Power Supply for LED BackLight Negative     |
| 15      | A        | Power Supply for LED BackLight Positive     |

**INTERFACE WITH CN3:**

| Pin No. | Symbol | Description                            |
|---------|--------|--|
| 1       | VSS    | Power Supply For Ground(0V)            |
| 2       | VDD    | Power Supply For Positive(+5V)         |
| 3       | VO     | VLCD Voltage Regulation Terminal       |
| 4       | /RD    | Read Signal Input Terminal             |
| 5       | /RW    | Write Signal Input Terminal            |
| 6       | /CE    | Chip Selection Terminal                |
| 7       | C/D    | Command/Data Selection Terminal        |
| 8       | DB0    | 8-bit bi-directional Data Bus          |
| 9       | DB1    |  |
| 10      | DB2    |  |
| 11      | DB3    |  |
| 12      | DB4    |  |
| 13      | DB5    |  |
| 14      | DB6    |  |
| 15      | DB7    |  |
| 16      | /RES   | Reset Selection Terminal               |
| 17      | VOUT   | Negative Voltage Input/Output Terminal |
| 18      | LEDA   | Power Supply for Backlight Positive    |
| 19      | LEDK   | Power Supply for Backlight Negative    |
| 20      | NC     | No Connect                             |



## 7.2 TIMING CHARACTERISTICS

### (1) Segment Driver Application

( $V_{SS} = 0V$ ,  $T_a = -30 \sim +85^\circ C$ )

| Characteristic                        | Symbol    | Test Condition | (1) $V_{DD} = 5V \pm 10\%$ |      |      | (2) $V_{DD} = 3V \pm 10\%$ |      |      | Unit    |
|---------------------------------------|-----------|----------------|----------------------------|------|------|----------------------------|------|------|---------|
|                                       |           |                | Min.                       | Typ. | Max. | Min.                       | Typ. | Max. |         |
| Clock cycle time                      | $t_{CY}$  | Duty = 50%     | 125                        | -    | -    | 250                        | -    | -    | ns      |
| Clock pulse width                     | $t_{WCK}$ | -              | 45                         | -    | -    | 95                         | -    | -    |         |
| Clock rise / fall time                | $t_R/t_F$ | -              | -                          | -    | -    | -                          | -    | 30   |         |
| Data set-up time                      | $t_{DS}$  | -              | 30                         | -    | -    | 65                         | -    | -    |         |
| Data hold time                        | $t_{DH}$  | -              | 30                         | -    | -    | 65                         | -    | -    |         |
| Clock set-up time                     | $t_{CS}$  | -              | 80                         | -    | -    | 120                        | -    | -    |         |
| Clock hold time                       | $t_{CH}$  | -              | 80                         | -    | -    | 120                        | -    | -    |         |
| Propagation delay time                | $t_{PHL}$ | ELB Output     | -                          | -    | 60   | -                          | -    | 125  |         |
|                                       |           | ERB Output     | -                          | -    | 60   | -                          | -    | 125  |         |
| ELB,ERB set-up time                   | $t_{PSU}$ | ELB Input      | 30                         | -    | -    | 65                         | -    | -    |         |
|                                       |           | ERB Input      | 30                         | -    | -    | 65                         | -    | -    |         |
| DISPOFFB low pulse width              | $t_{WDL}$ | -              | 1.2                        | -    | -    | 1.2                        | -    | -    | $\mu s$ |
| DISPOFFB clear time                   | $t_{CD}$  | -              | 100                        | -    | -    | 100                        | -    | -    | ns      |
| M - OUT propagation delay time        | $t_{PD1}$ | $C_L = 15pF$   | -                          | -    | 1.0  | -                          | -    | 1.2  | $\mu s$ |
| CL1 - OUT propagation delay time      | $t_{PD2}$ |                | -                          | -    | 1.0  | -                          | -    | 1.2  |         |
| DISPOFFB - OUT propagation delay time | $t_{PD3}$ |                | -                          | -    | 1.0  | -                          | -    | -    |         |

**(2) Common Driver Application**
 $(V_{SS} = 0V, T_a = -30 - +85^{\circ}C)$ 

| Characteristic                        | Symbol    | Test Condition | (1) $V_{DD} = 5V \pm 10\%$ |      |      | (2) $V_{DD} = 3V \pm 10\%$ |      |      | Unit    |
|---------------------------------------|-----------|----------------|----------------------------|------|------|----------------------------|------|------|---------|
|                                       |           |                | Min.                       | Typ. | Max. | Min.                       | Typ. | Max. |         |
| Clock cycle time                      | $t_{CY}$  | Duty = 50%     | 250                        | -    | -    | 500                        | -    | -    | ns      |
| Clock pulse width                     | $t_{WCK}$ | -              | 45                         | -    | -    | 95                         | -    | -    |         |
| Clock rise / fall time                | $t_R/t_F$ | -              | -                          | -    | 50   | -                          | -    | 50   |         |
| Data set-up time                      | $t_{DS}$  | -              | 30                         | -    | -    | 65                         | -    | -    |         |
| Data hold time                        | $t_{DH}$  | -              | 30                         | -    | -    | 65                         | -    | -    |         |
| DISPOFFB low pulse width              | $t_{WDL}$ | -              | 1.2                        | -    | -    | 1.2                        | -    | -    | $\mu s$ |
| DISPOFFB clear time                   | $t_{CD}$  | -              | 100                        | -    | -    | 100                        | -    | -    | ns      |
| Output delay time                     | $t_{DL}$  | $C_L = 15pF$   | -                          | -    | 200  | -                          | -    | 250  | $\mu s$ |
| M – OUT propagation delay time        | $t_{PD1}$ |                | -                          | -    | 1.0  | -                          | -    | 1.2  |         |
| CL1 - OUT propagation delay time      | $t_{PD2}$ |                | -                          | -    | 1.0  | -                          | -    | 1.2  |         |
| DISPOFFB - OUT propagation delay time | $t_{PD3}$ |                | -                          | -    | 1.0  | -                          | -    | 1.2  |         |

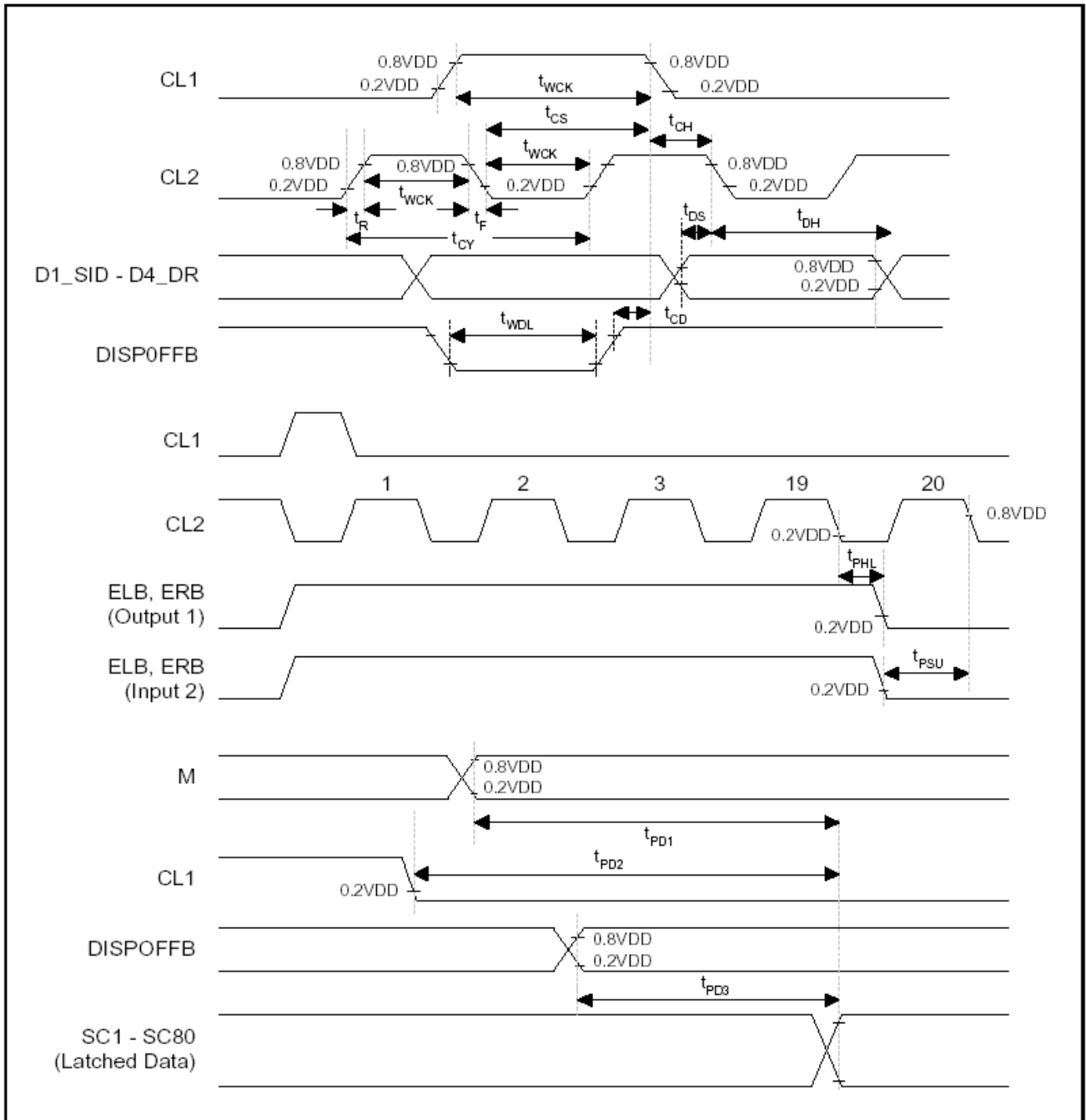
**(3) Segment Driver Application Timing**

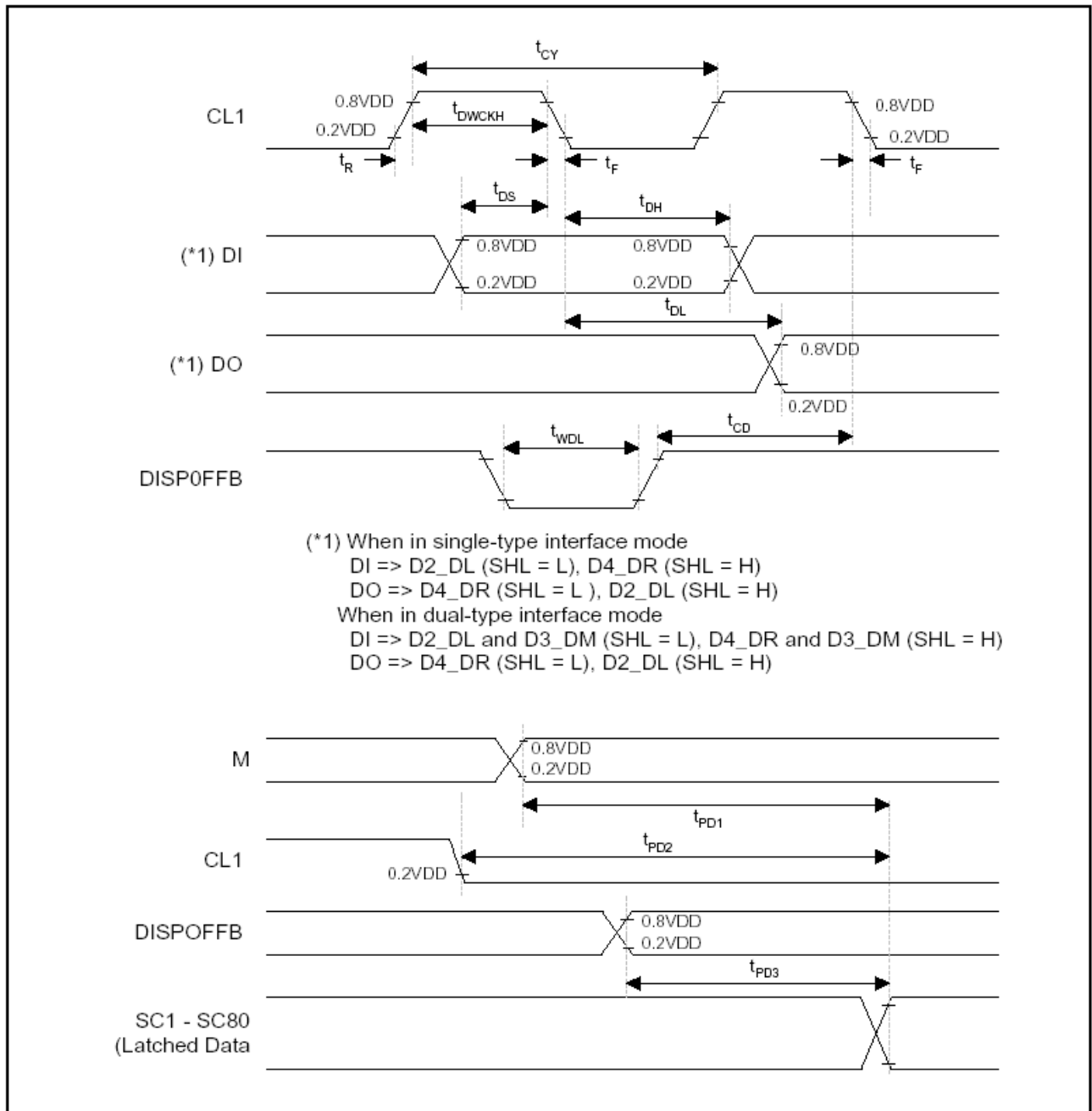
**(4) Common Driver Application Timing**



(5) Common / Segment Driver Timing (1/160 DUTY)

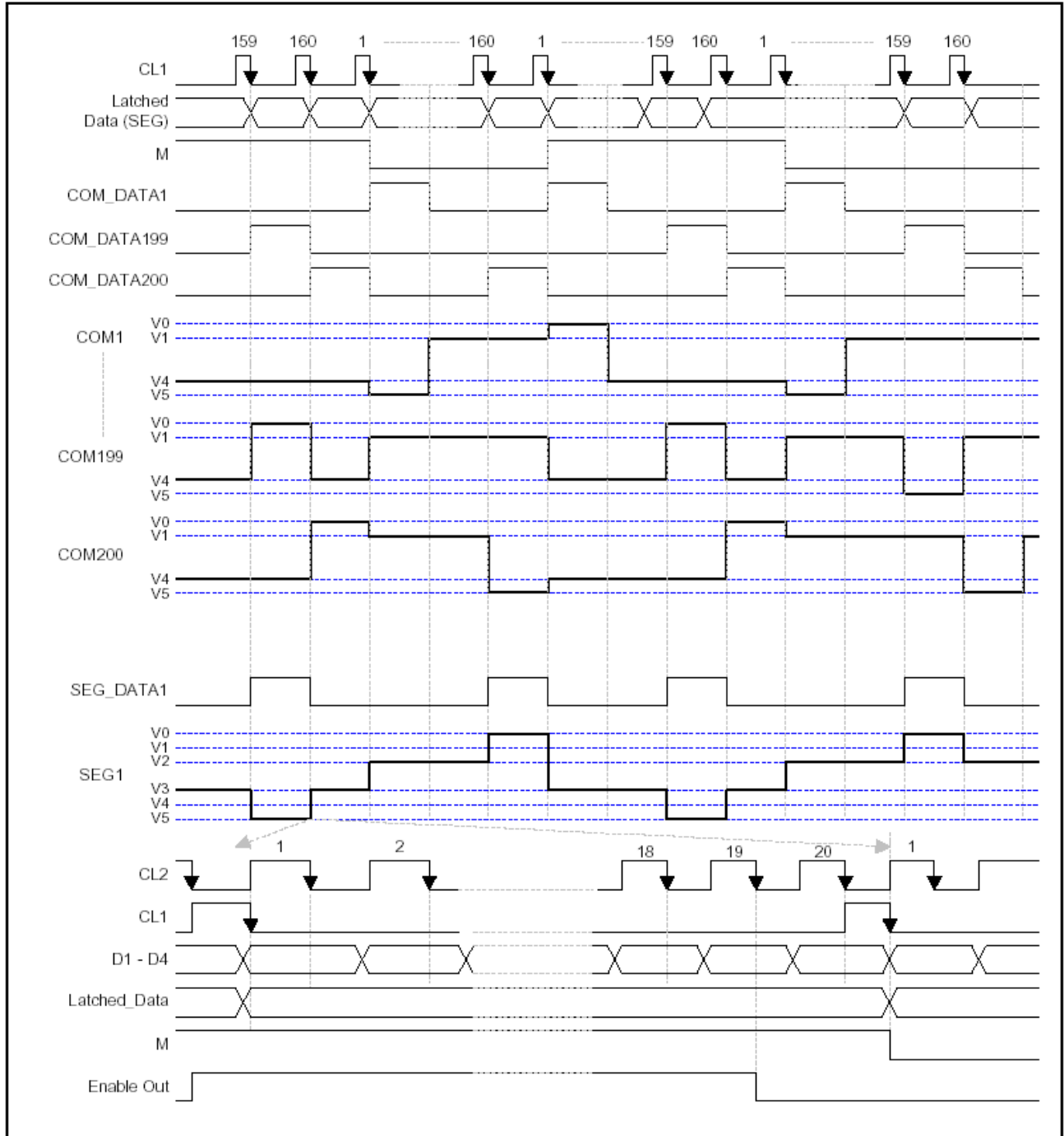

### 7.3 APPLICATION OF LCM

#### ■Circuit Block Diagram

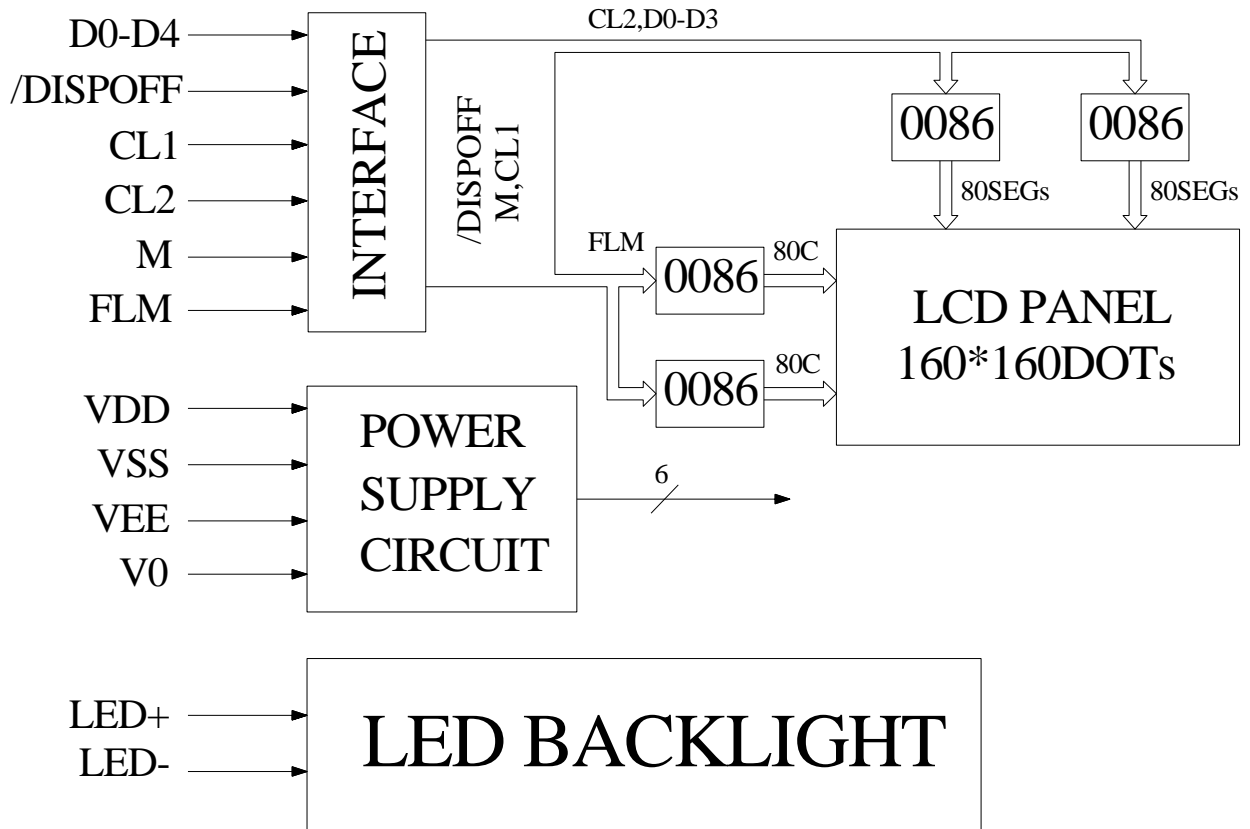

## 8. ELECTRO-OPTICAL CHARACTERISTICS

| Item                | Symbol           | Condition           | Temp | Min  | Typ. | Max  | Units | Note  |
|---------------------|------------------|---------------------|------|------|------|------|-------|-------|
| LCD driving voltage | V <sub>LCD</sub> | $\theta = \phi = 0$ | 0°C  | ---  | 17.2 | ---  | V     | NOTE1 |
|                     |                  |                     | 25°C | 17.0 | 17.5 | 18.0 |       |       |
|                     |                  |                     | 50°C | ---  | 17.8 | ---  |       |       |
| Response Time       | Rise Time (Tr)   | $\theta = \phi = 0$ | 0°C  | ---  | ---  | --   | msec  | NOTE2 |
|                     | Decay Time (Tf)  |                     |      | ---  | ---  | ---  |       |       |
|                     | Rise Time (Tr)   |                     | 25°C | ---  | 225  | 340  |       |       |
|                     | Decay Time (Tf)  |                     |      | ---  | 240  | 360  |       |       |
|                     | Rise Time (Tr)   |                     | 50°C | ---  | ---  | --   |       |       |
|                     | Decay Time (Tf)  |                     |      | ---  | ---  | --   |       |       |
| Contrast Ratio      | Cr               | $\theta = \phi = 0$ | 25°C | 5    | 10   | ---  | ---   | NOTE4 |

| Viewing Angle Range                        | $\theta (\phi = 0^\circ)$<br>(6'') | $\phi = 90^\circ$<br>(3'') | $\phi = 180^\circ$<br>(12'') | $\phi = 270^\circ$<br>(9'') | 備註           |
|--|------------------------------------|----------------------------|------------------------------|-----------------------------|--------------|
| $\theta (25^\circ\text{C})$<br>CR $\geq$ 2 | 45                                 | 35                         | 25                           | 35                          | Deg<br>NOTE3 |

● For panel only

• **Electro-Optical Characteristics Measuring Equipment(DMS501)**

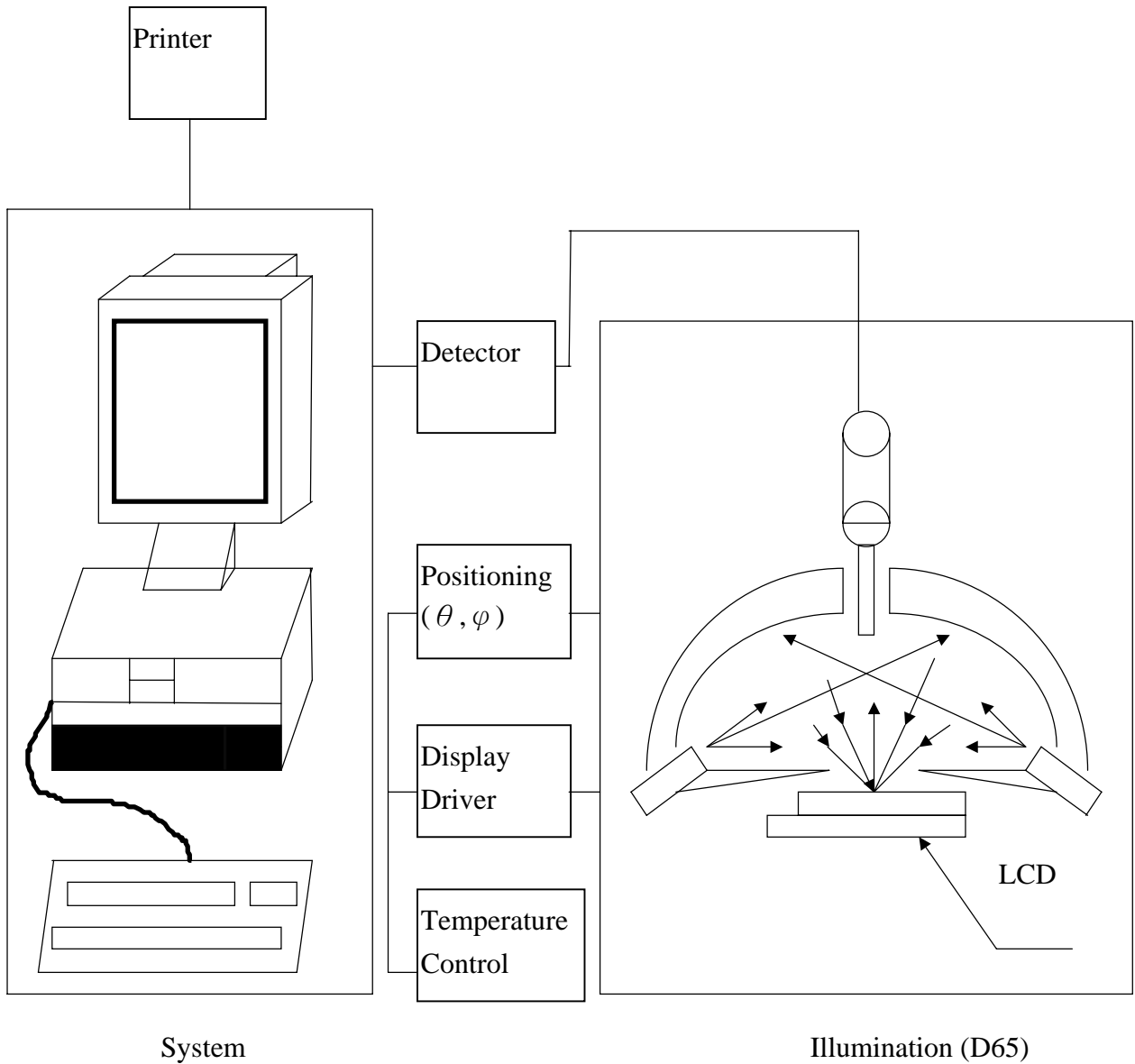



• **Note 1. Definition of Driving Voltage(  $V_{lcd}$  ) :**

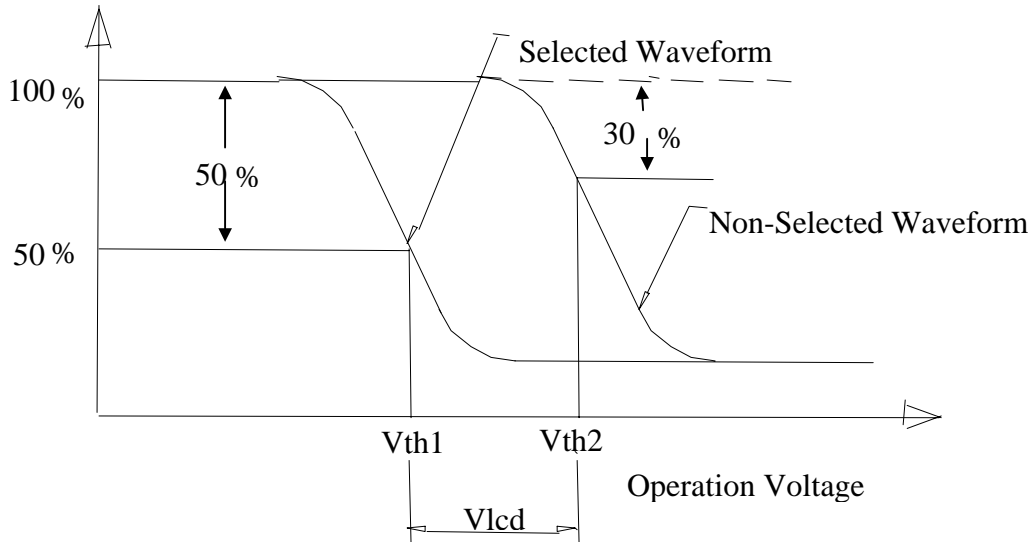

• **Note 2. Definition of Optical Response Time :**

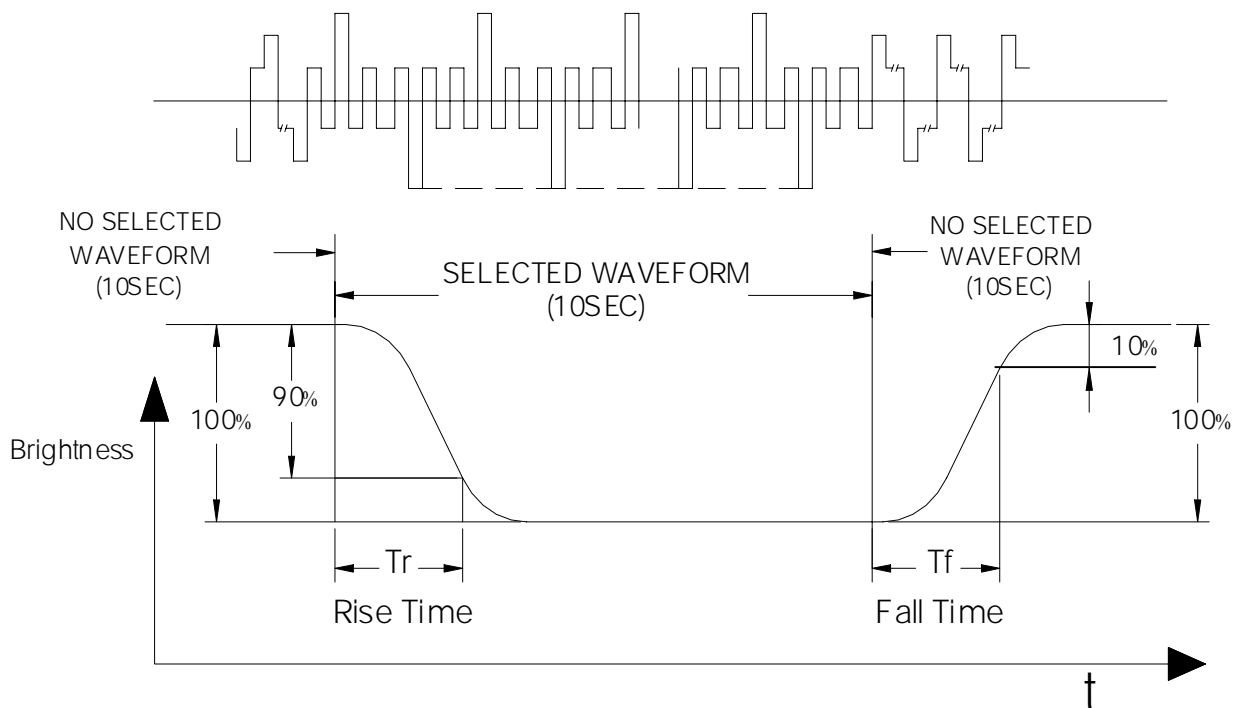

• **Note 3. Definition of Viewing Angle  $\theta$  and  $\phi$  :**

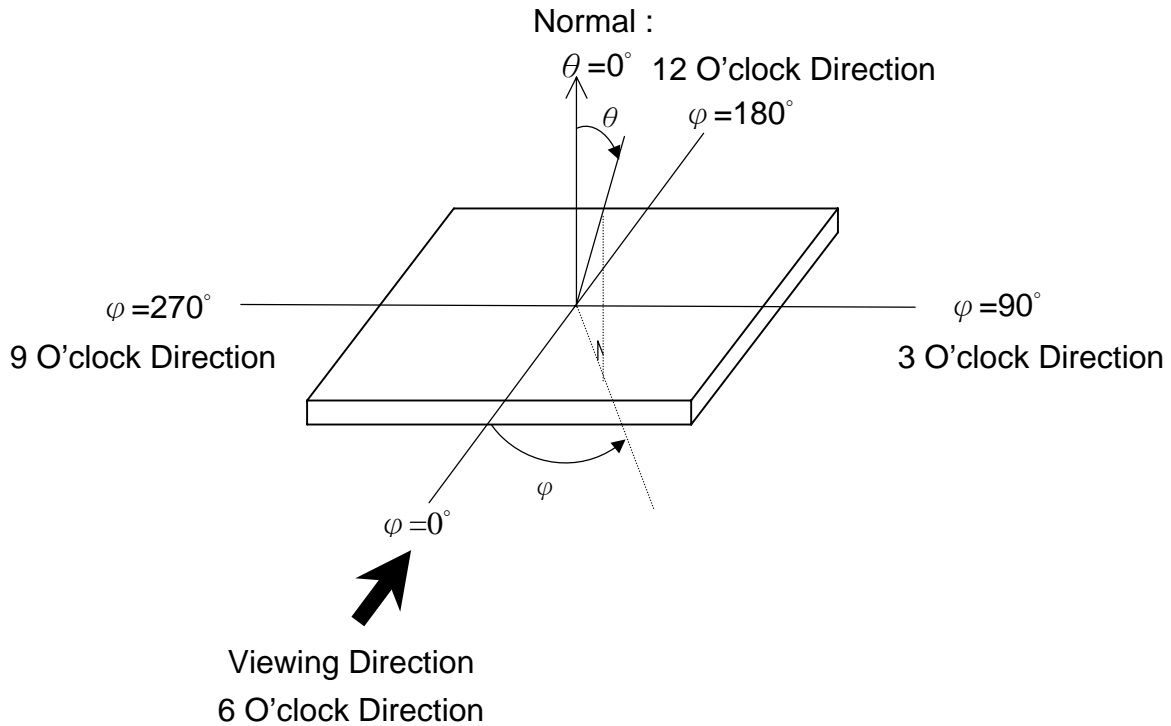

• **Note 4. Definition of Contrast ratio( CR) :**

$$CR = \frac{\text{Brightness of Non-selected Segment (B2)}}{\text{Brightness of Selected Segment (B1)}}$$

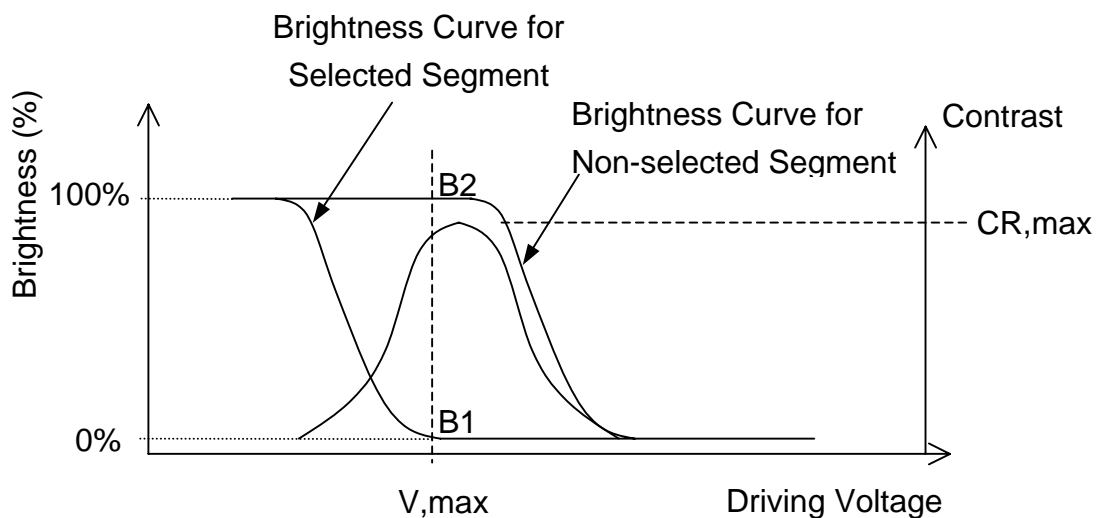

## 9. RELIABILITY

### 9.1. MTBF

The LCD module shall be designed to meet a minimum MTBF value of 50000 hours with normal. (25°C in the room without sunlight)

### 9.2. TESTS

| NO. | ITEM  | CONDITION                               | CRITERION   |
|-----|---|---|---|
| 1   | High Temperature Operating                  | 50°C 120Hrs                             | <ul style="list-style-type: none"> <li>◦ No Defect Of Operational Function In Room Temperature Are Allowable.</li> <li>◦ IDD of LCM in Pre-and post-test should follow specification</li> </ul> |
| 2   | Low Temperature Operating                   | 0°C 120Hrs                              |   |
| 3   | High Temperature/<br>Humidity Non-Operating | 50°C ,90%RH ,120 Hrs                    |   |
| 4   | High Temperature<br>Non-Operating           | 60°C 120Hrs                             |   |
| 5   | Low Temperature<br>Non-Operating            | -10°C 120Hrs                            |   |
| 6   | Temperature Cycling<br>Non-Operating        | 0°C (30Min )↔ 50°C (30Min)<br>10 CYCLES |   |

Notes: Judgments should be made after exposure in room temperature for two hours.

## **10. PRECAUTIONS FOR USING LCD MODULES**

### **10.1. HANDLING PRECAUTIONS**

- (1) The display panel is made of glass. Do not subject it to a mechanical shock or impact by dropping it.
- (2) If the display panel is damaged and the liquid crystal substance leaks out, be sure not to get any in your mouth. If the substance contacts your skin or clothes, wash it off using soap and water.
- (3) Do not apply excessive force to the display surface or the adjoining areas since this may cause the color tone to vary.
- (4) The polarizer covering the display surface of the LCD module is soft and easily scratched. Handle this polarizer carefully.
- (5) If the display surface becomes contaminated, breathe on the surface and gently wipe it with a soft dry cloth. If it is heavily contaminated, moisten a cloth with one of the following solvents:
  - Isopropyl alcohol
  - Ethyl alcohol
- (6) Solvents other than those above mentioned may damage the polarizer.  
Especially, do not use the following:
  - Water
  - Ketone
  - Aromatic solvents
- (7) Extra care to minimize corrosion of the electrode. Water droplets, moisture condensation or a current flow in a high-humidity environment accelerates corrosion of the electrode.
- (8) Install the LCD Module by using the mounting holes. When mounting the LCD Module, make sure it is free of twisting, warping and distortion. In particular, do not forcibly pull or bend the I/O cable or the backlight cable.
- (9) Do not attempt to disassemble or process the LCD Module.
- (10) NC terminal should be open. Do not connect anything.
- (11) If the logic circuit power is off, do not apply the input signals.
- (12) To prevent destruction of the elements by static electricity, be careful to maintain an optimum work environment.
  - Be sure to ground the body when handling the LCD Module.
  - Tools required for assembling, such as soldering irons, must be properly grounded.
  - To reduce the amount of static electricity generated, do not conduct assembling and other work under dry conditions.

-The LCD Module is coated with a film to protect the display surface. Exercise care when peeling off this protective film since static electricity may be generated.

## 10.2. STORAGE CONDITIONS

When storing, avoid the LCD module to be exposed to direct sunlight of fluorescent lamps. For stability, to keep it away from high temperature and high humidity environment (The best condition is :  $23\pm 5^{\circ}\text{C}$ ,  $45\pm 20\% \text{RH}$ ). ESD protection is necessary for long-term storage also.

## 10.3. OTHERS

Liquid crystals solidify under low temperature (below the storage temperature range) leading to defective orientation or the generation of air bubbles (black or white). Air bubbles may also be generated if the module is subject to a low temperature.

If the LCD Module have been operating for a long time showing the same display patterns the display patterns may remain on the screen as ghost images and a slight contrast irregularity may also appear. A normal operating status can be recovered by suspending use for some time. It should be noted that this phenomenon does not adversely affect performance reliability.

To minimize the performance degradation of the LCD Module resulting from destruction caused by static electricity etc. exercise care to avoid holding the following sections when handling the modules.

- Exposed area of the printed circuit board.
- Terminal electrode sections.

## **11. Using LCD modules**

### **11.1 LIQUID CRYSTAL DISPLAY MODULES**

LCD is composed of glass and polarizer. Pay attention to the following items when handling.

- (1) Please keep the temperature within specified range for use and storage. Polarization degradation, bubble generation or polarizer peel-off may occur with high temperature and high humidity.
- (2) Do not touch, push or rub the exposed polarizers with anything harder than a HB pencil lead (glass, tweezers, etc).
- (3) N-hexane is recommended for cleaning the adhesives used to attach front/rear polarizers and reflectors made of organic substances, which will be damaged by chemicals such as acetone, toluene, toluene, ethanol and isopropyl alcohol.
- (4) When the display surface becomes dusty, wipe gently with absorbent cotton or other soft material like chamois soaked in petroleum ether. Do not scrub hard to avoid damaging the display surface.
- (5) Wipe off saliva or water drops immediately, contact with water over a long period of time may cause deformation or color fading.
- (6) Avoid contacting oil and fats.
- (7) Condensation on the surface and contact with terminals due to cold will damage, stain or polarizers. After products are tested at low temperature they must be warmed up in a container before coming is contacting with room temperature air.
- (8) Do not put or attach anything on the display area to avoid leaving marks on.
- (9) Do not touch the display with bare hands. This will stain the display area and degrade insulation between terminals (some cosmetics are determinate to the polarizers).
- (10) As glass is fragile, it tends to become or chipped during handling especially on the edges. Please avoid dropping or jarring.

### **11.2 INSTALLING LCD MODULE**

Attend to the following items when installing the LCM.

- (1) Cover the surface with a transparent protective plate to protect the polarizer and LC cell.
- (2) When assembling the LCM into other equipment, the spacer to the bit between the LCM and the fitting plate should have enough height to avoid causing stress to the module surface, refer to the individual specifications for measurements. The measurement tolerance should be  $\pm 0.1$ mm.

### **11.3 ELECTRO-STATIC DISCHARGE CONTROL**

Since this module uses a CMOS LSI, the same careful attention should be paid for electrostatic discharge as for an ordinary CMOS IC.

- (1) Make certain that you are grounded when handling LCM.
- (2) Before removing LCM from its packing case or incorporating it into a set, be sure the module and your body have the same electric potential.
- (3) When soldering the terminal of LCM, make certain the AC power source for the soldering iron does not leak.
- (4) When using an electric screwdriver to attach LCM, the screwdriver should be of ground potentiality to minimize as much as possible any transmission of electromagnetic waves produced sparks coming from the commutator of the motor.
- (5) As far as possible, make the electric potential of your work clothes and that of the workbenches to the ground potential.
- (6) To reduce the generation of electro-static discharge, be careful that the air in the work is not too dried. A relative humidity of 50%-60% is recommended.

#### 11.4 PRECAUTIONS FOR OPERATION

- (1) Viewing angle varies with the change of liquid crystal driving voltage ( $V_o$ ). Adjust  $V_o$  to show the best contrast.
- (2) Driving the LCD in the voltage above the limit will shorten its lifetime.
- (3) Response time is greatly delayed at temperature below the operating temperature range. However, this does not mean the LCD will be out of the order. It will recover when it returns to the specified temperature range.
- (4) If the display area is pushed hard during operation, the display will become abnormal. However, it will return to normal if it is turned off and then on.
- (5) Condensation on terminals can cause an electrochemical reaction disrupting the terminal circuit. Therefore, this product must be used and stored within the specified condition of  $23\pm 5^{\circ}\text{C}$ ,  $45\pm 20\% \text{RH}$ .
- (6) When turning the power on, input each signal after the positive/negative voltage becomes stable.

#### 11.5 SAFETY

- (1) It is recommended to crush damaged or unnecessary LCDs into pieces and wash them off with solvents such as acetone and ethanol, which should later be burned.
- (2) If any liquid leaks out of a damaged glass cell and comes in contact with the hands, wash off thoroughly with soap and water.



## 12. REVISION HISTORY

| Version | Revise record       | Date     |
|---------|---------------------|----------|
| 1.0     | Original version    | 05-12-19 |
| 2.0     | Change Outline      | 06-04-26 |
| 3.0     | Change contact mode | 06-08-04 |
|         |                     |          |
|         |                     |          |
|         |                     |          |
|         |                     |          |
|         |                     |          |
|         |                     |          |
|         |                     |          |
|         |                     |          |
|         |                     |          |
|         |                     |          |
|         |                     |          |
|         |                     |          |
|         |                     |          |
|         |                     |          |
|         |                     |          |
|         |                     |          |
|         |                     |          |



## SAMPLE APPROVED REPORT (样品确认单)

|  |                        |
|--|------------------------|
| SAMPLE MODEL NO. (样品型号)  | GB160160A              |
| SAMPLE SERIES NUMBER NO. (样品序号)  |                        |
| SAMPLE QUANTITY (样品数量)   |                        |
| COLOR/TYPE (底色/类型)   | YELLOW-GREEN           |
| VIEWING DIRECTION (视角)   | 6:00                   |
| DRIVING METHOD (驱动参数)  | 1/160Duty, 1/12Bias    |
| LOGIC VOLTAGE (工作电压)   | 5.0V                   |
| LCD VOP (LCD 驱动电压)   | 17.5V                  |
| OPERATING TEMP. (操作温度)   | 0~50                   |
| STORAGE TEMP. (储存温度)   | -10~60                 |
| POLARIZER MODE (偏光片模式)   | TRANSFLECTIVE/POSITIVE |
| CONTROLLER/DRIVER IC(控制/驱动 IC)   | NONE/S6B0086           |
| BACKLIGHT COLOR/TYPE (背光源类型/颜色)  | LED/YELLOW-GREEN       |
| DRAWING REV/NO./QUANTITY (图纸版本/数量)   |                        |
| SPECIFICATION (规格书 份数)   |                        |
| REMARKS :<br>(备注)  |                        |
| WRIT BY : _____ DATE : _____ APROV BY : _____ DATE : _____                               |                        |
| CUSTOMER'S APPROVAL (客户确认) :   |                        |
| 1) FUNCTION (功能) : <input type="checkbox"/> OK <input type="checkbox"/> N.G.             |                        |
| 2) DRIVER CONDITION (驱动条件) : <input type="checkbox"/> OK <input type="checkbox"/> N.G.   |                        |
| 3) DISPLAY MODE (显示模式) : <input type="checkbox"/> OK <input type="checkbox"/> N.G.       |                        |
| 4) VIEWING ANGLE (视角) : <input type="checkbox"/> OK <input type="checkbox"/> N.G.        |                        |
| 5) BACKLIGHT (背光源) : <input type="checkbox"/> OK <input type="checkbox"/> N.G.           |                        |
| 6) DISPLAYING PATTERN (显示效果) : <input type="checkbox"/> OK <input type="checkbox"/> N.G. |                        |
| CUSTOMER'S CONCLUSIONS (客户意见) : _____  |                        |
| _____  |                        |
| _____  |                        |
| CUSTOMER'S SIGNATURE (客户签名) : _____ DATE (日期) : _____                                    |                        |