

Distinctive Characteristics

Full face and spot illumination available. Front panel relamping.

Choice of super bright LEDs in white, green, and blue in addition to bright red, amber, and green LEDs.

Compact front panel design with 9mm square or round bezel options.

Rear panel threaded mounting. Behind panel depth of less than one inch. 8mm body diameter fits common size panel cutout.

Latchdown feature gives indication of circuit status. Audible and tactile feedback with smooth and responsive operation.

Dual, sliding contacts with self-cleaning action provide contact stability, high reliability, and increased operating life.

Solder lug terminals have spacing of .100" (2.54mm) for choice of mounting.

Longer normally closed terminal facilitates wiring and soldering.

Molded-in terminals lock out flux, dust, and other contaminants.

Nonilluminated models available.

Matching indicators available.

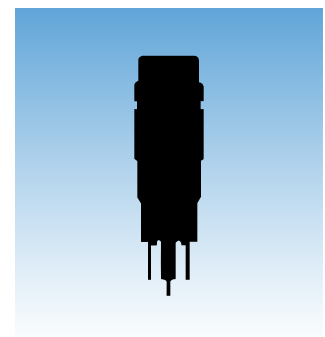
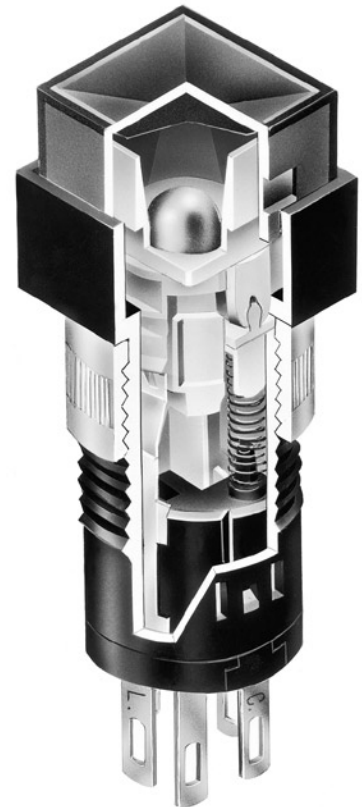

General Specifications

Electrical Capacity (Resistive Load)

Power Level (code W): 0.1A maximum @ 30V AC/DC

Other Ratings

Contact Resistance: 50 milliohms maximum
Insulation Resistance: 100 megohms minimum @ 500V DC
Dielectric Strength: 500V AC minimum for 1 minute minimum
Mechanical Life: 100,000 operations minimum
Electrical Life: 50,000 operations minimum
Nominal Operating Force: 3.43N
Contact Timing: Nonshorting (break before make)
Travel: Pretravel .087" (2.2mm); Overtravel .031" (0.8mm); Total Travel .118" (3.0mm)

Materials & Finishes

Housing: Glass fiber reinforced polyamide
Base: Glass fiber reinforced polyamide
Movable Contact: Phosphor bronze with silver plating
Stationary Contacts: Phosphor bronze with silver plating
Common Terminal: Phosphor bronze with silver plating
End Terminals: Phosphor bronze with silver plating
Lamp Terminals: Phosphor bronze with silver plating

Environmental Data

Operating Temp Range: -25°C through +50°C (-13°F through +122°F)
Humidity: 90 ~ 95% humidity for 96 hours @ 40°C (104°F)
Vibration: 10 ~ 55Hz with peak-to-peak amplitude of 1.5mm traversing the frequency range & returning in 1 minute; 3 right angled directions for 2 hours
Shock: 50G (490m/s²) acceleration (tested in 6 right angled directions, with 5 shocks in each direction)

Installation

Mounting Torque: 0.49Nm (4.34 lb•in) maximum for round mounting nut
Cap Installation Force: 9.8N (2.2 lbf) maximum downward force on cap
Soldering Time & Temperature: 4 seconds maximum @ 390°C maximum for manual soldering
 Note: Find additional processing data in Supplement section.

Standards & Certifications



UL & C-UL Recognized: All models recognized at 0.1A @ 30V AC/DC;
 UL File No. WOYR2.E44145;
 add "/U" to end of part number to order UL mark on switch.
 C-UL File No. WOYR8.E44145;
 add "/UC" to end of part number to order C-UL mark on switch.



TYPICAL SWITCH ORDERING EXAMPLE

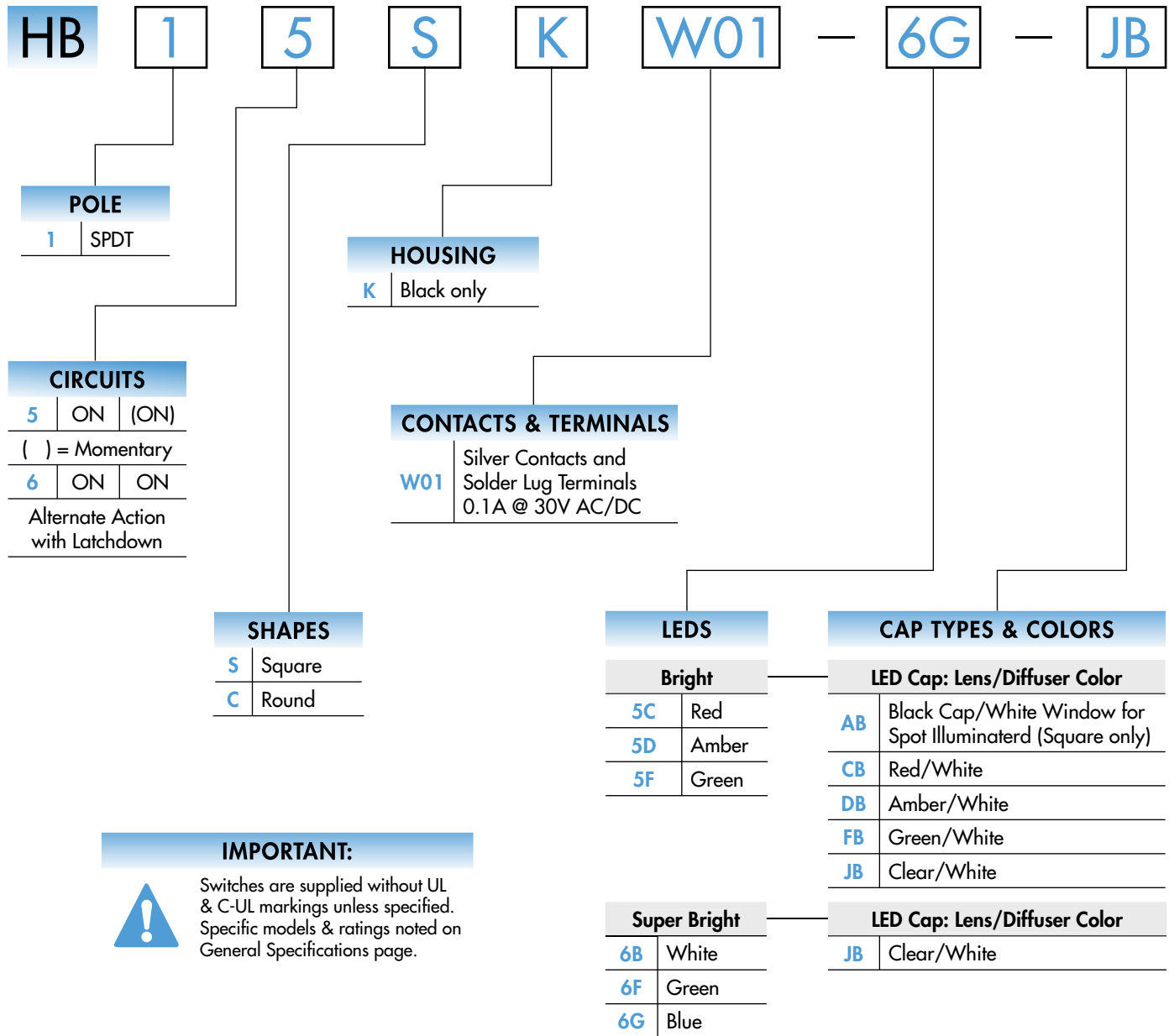

DESCRIPTION FOR TYPICAL ORDERING EXAMPLE

HB15SKW01-6G-JB

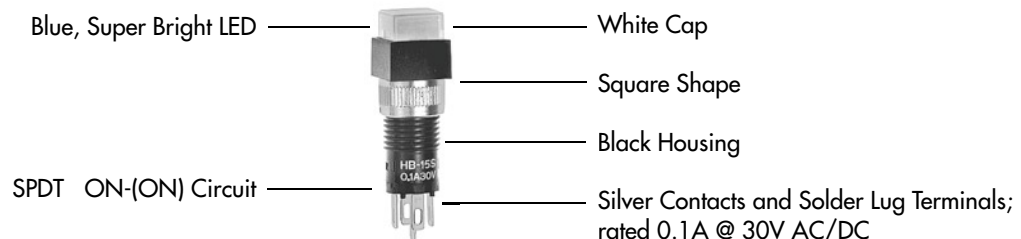

POLES & CIRCUITS

Pole	Model	Plunger Position () = Momentary		Connected Terminals		Throw & Switch/Lamp Schematics
		Normal	Down	Normal	Down	
						Notes: Switch is marked with NO, NC, C, L. LED circuit is isolated and requires external power source.
SP	HB15 *HB16	ON ON	(ON) ON	1-3	1-2	SPDT

* When in latchdown position for the alternate circuit, cap position is .051" (1.3mm) above the built-in bezel.

SHAPES

S .354" (9mm) Square

The bezel is an integral part of the switch body.

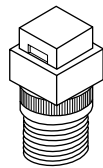

C .354" (9mm) Round

The bezel is an integral part of the switch body.

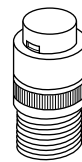

Panel Cutout & Mounting

Recommended Panel Thickness:
.020 ~ .197" (0.5 ~ 5.0mm)

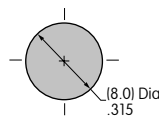

Overtightening the mounting nut AT073 may damage the switch housing.

HOUSING

K Housing available in black only.

CONTACT MATERIALS, RATINGS, & TERMINALS

W01 Silver Contacts

Power Level

0.1A maximum @ 30V AC/DC

Solder Lug

The .039" x .079" (1.0mm x 2.0mm) oblong hole accommodates one solid or one stranded 20-gauge wire or two 22-gauge wires.

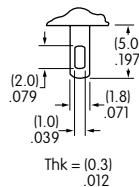



PCB Mounting

Solder lug terminals are spaced .100" x .200" (2.54mm x 5.08mm). This enables PCB mounting which can be accomplished by elongating PC board holes to .080" (2.03mm).

LED COLORS & SPECIFICATIONS

The electrical specifications shown are determined at a basic temperature of 25°C.
 LED circuit is isolated and requires external power source. Single element LED is colored in OFF state.
 If the source voltage exceeds the rated voltage, a ballast resistor is required.
 The resistor value can be calculated by using the formula in the Supplement section.

Bright AT633		Note for Super Bright: 	Bright			Super Bright			Unit	
			5C	5D	5F	6B	6F	6G		
Super Bright		Color	Red	Amber	Green	White	Green	Blue		
AT624G Blue		Forward Peak Current	I_{FM}	30	30	25	30	30	30	mA
		Continuous Forward Current	I_F	20	20	20	20	20	20	mA
AT629B White		Forward Voltage	V_F	1.85	2.0	2.2	3.6	3.5	3.6	V
AT630F Green		Reverse Peak Voltage	V_{RM}	5	5	5	5	5	5	V
		Current Reduction Rate Above 25°C	ΔI_F	0.40	0.42	0.38	0.50	0.50	0.50	mA/°C
T-1 Bi-pin		Ambient Temperature Range		-25° ~ +50°C			-25° ~ +50°C			

CAP TYPES & COLORS

Color Codes: A Black B White C Red D Amber F Green J Clear

Colored Cap for Bright LEDs

Cap Colors Available:

AB Black Cap with Translucent White Window for LED Display

AT4052
Spot Illuminated

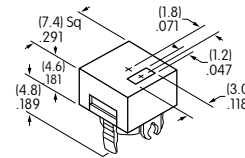

Square only

Material: Polycarbonate
Finish: Matte

Lens/Diffuser
Colors Available:

CB Red/White

DB Amber/White

FB Green/White

AT4166
Square

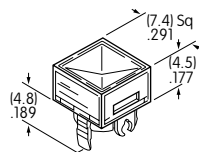

AT4167
Round

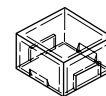
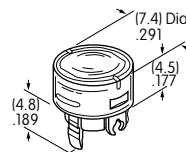

Transparent Colored Lens



Translucent White Diffuser



Colored LED
AT633

Material: Polycarbonate Finish: Glossy

White Cap for Bright & Super Bright LEDs

JB Clear Lens/
White Diffuser

Material: Polycarbonate
Finish: Glossy

AT4031
Square

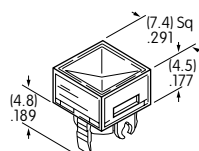

AT4032
Round

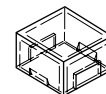
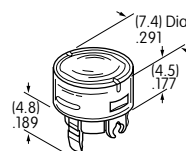

Transparent Clear Lens



Translucent White Diffuser



Colored LEDs
AT624, AT629,
AT630, or AT633

TYPICAL SWITCH DIMENSIONS

Square

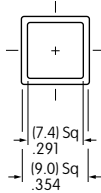

Single Pole

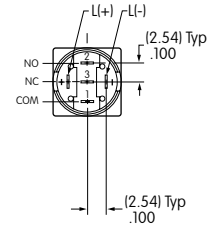
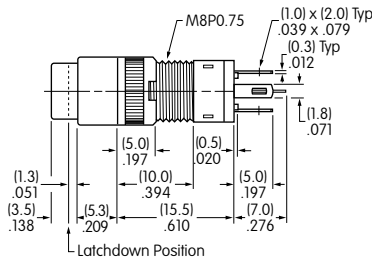

HB15KW01-5C-CB

Round

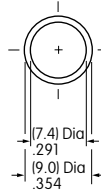

Single Pole

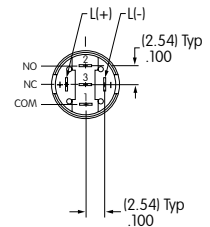
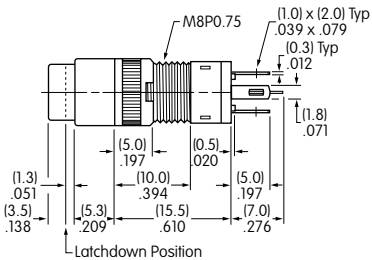

HB16CKW01-5C-CB

ASSEMBLY INSTRUCTIONS

Cap Removal

1. Have cap in extended position (not latched) for alternate action models.
2. Use the grip slots on the sides of the cap and pull it out of the switch.

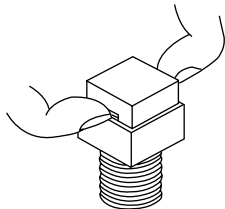

LED Polarity & Orientation in Lamp Socket

For AT624, AT629, AT630: Insert the LED with the D flat opposite the black dot molded inside the switch lamp socket. For AT633: Insert the LED with the Black Dot on the terminal to the right.

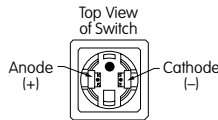
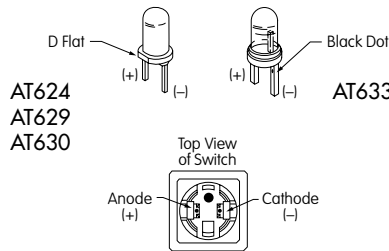

Super Bright LEDs AT624, AT629, & AT630 are electrostatic sensitive.

Cap Replacement

1. Match the prongs on the cap base with the projections in the switch, at the same time lining the spring clips on the cap with the indentations in the switch.
2. Press firmly in place.

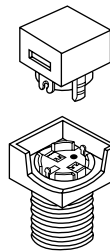

AT111 Lamping Tool

Lamping Tool AT111 may be used to remove and replace LED.



AT110 Socket Wrench

Socket Wrench AT110 may be used to tighten the mounting nut.

