



**DESCRIPTION**

The popular 1N4565 thru 1N4584A-1 series of Zero-TC Reference Diodes provides a selection of both 6.4 V nominal voltages and temperature coefficients to as low as 0.0005%/°C for minimal voltage change with temperature. Four different operating currents are available for selection at 0.5 mA, 1.0 mA, 2.00 mA, and 4.00 mA. These glass axial-leaded DO-7 reference diodes are internal-metallurgical-bonded and are also available in JAN, JANTX, and JANTXV military qualifications. Microsemi also offers numerous other Zener Reference Diode products for a variety of other voltages up to 200 V.

**APPEARANCE**

**DO-7  
(DO-204AA)**

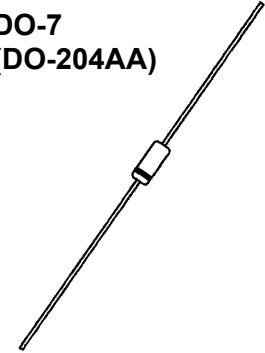

**IMPORTANT:** For the most current data, consult MICROSEMI's website: <http://www.microsemi.com>

**FEATURES**

- JEDEC registered 1N4565 thru 1N4584 series .
- Reference voltage diodes of nominal 6.4 V +/- 5% with tighter tolerance options available
- Temperature Coefficient range: 0.01%/°C to 0.0005%/°C.
- Zener Test Current selection range: 0.500 mA, 1.00 mA, 2.00 mA and 4.00 mA.
- Internal metallurgical bonded
- 1N4565 thru 1N4584 also have qualification to MIL-PRF-19500/452 by adding the JAN, JANTX, JANTXV, or JANS prefixes to part numbers as well as the "-1" suffix; e.g. JANTX1N4574A-1, etc.
- Military surface mount equivalents also available in DO-213AA by adding UR-1 suffix and the JAN, JANTX, and JANTXV prefix, e.g. JANTX1N4569AUR-1 (see separate data sheet)
- Also available in DO-35 package including military qualifications up to JANTXV (see separate data sheet)

**APPLICATIONS / BENEFITS**

- Provides minimal voltage change over a broad operating temperature range for instrumentation and other circuit designs requiring a voltage reference
- Temperature coefficient selections available from 0.01%/°C to 0.0005%/°C
- Tight reference voltage tolerances available with nominal value of 6.4 V by adding tolerance 1%, 2%, 3%, etc. after the part number for identification, e.g. 1N4569-2%, 1N4579A-1%, 1N4574A-1-1%, etc.
- Flexible axial-leaded mounting terminals
- Nonsensitive to ESD per MIL-STD-750 Method 1020

**MAXIMUM RATINGS**

- Operating Temperatures: -65°C to +175°C
- Storage Temperatures: -65°C to +175°C
- DC Power Dissipation: 500 mW @ T<sub>L</sub> = 25°C with maximum current I<sub>ZM</sub> 70 mA. NOTE: For optimum voltage-temperature stability, the operating test current (I<sub>ZT</sub>) should be as specified in the Electrical Characteristics Table (power less than 30 mW)
- Solder Temperatures: 260°C for 10 s (max)

**MECHANICAL AND PACKAGING**

- CASE: Hermetically sealed glass case. DO-7 (DO-204AA) package
- TERMINALS: Leads, tin-lead plated solderable per MIL-STD-750, Method 2026
- MARKING: Part number and cathode band
- POLARITY: Reference diode to be operated with the banded end positive with respect to the opposite end
- TAPE & REEL option: Standard per EIA-296 (add "TR" suffix to part number)
- WEIGHT: 0.2 grams.
- See package dimensions on last page



1N4565(A)(-1) thru 1N4584(A)(-1) DO-7

**\*ELECTRICAL CHARACTERISTICS @ 25°C, unless otherwise specified**

JEDEC TYPE Number (Notes 1, 4 & 5)	ZENER TEST CURRENT (Note 3) $I_{ZT}$ mA	MAXIMUM VOLTAGE TEMPERATURE COEFFICIENT			MAXIMUM REVERSE CURRENT $I_R @ 3 V$ $\mu A$	MAX. DYNAMIC IMPEDANCE (Note 2) $Z_{ZT} @ I_{ZT}$ OHMS
		$\alpha_{VZ} +/- \% / ^\circ C$	$+/- mV / ^\circ C$	Temp. Range		
1N4565	.5	.01	.64	0 to +75°C	2.0	200
1N4565A	.5	.01	.64	-55 to +100°C	2.0	200
1N4566	.5	.005	.32	0 to +75°C	2.0	200
1N4566A	.5	.005	.32	-55 to +100°C	2.0	200
1N4567	.5	.002	.13	0 to +75°C	2.0	200
1N4567A	.5	.002	.13	-55 to +100°C	2.0	200
1N4568	.5	.001	.06	0 to +75°C	2.0	200
1N4568A	.5	.001	.06	-55 to +100°C	2.0	200
1N4569	.5	.0005	.03	0 to +75°C	2.0	200
1N4569A	.5	.0005	.03	-55 to +100°C	2.0	200
1N4570	.5	.01	.64	0 to +75°C	2.0	100
1N4570A	.5	.01	.64	-55 to +100°C	2.0	100
1N4571	1.0	.005	.32	0 to +75°C	2.0	100
1N4571A	1.0	.005	.32	-55 to +100°C	2.0	100
1N4572	1.0	.002	.13	0 to +75°C	2.0	100
1N4572A	1.0	.002	.13	-55 to +100°C	2.0	100
1N4573	1.0	.001	.06	0 to +75°C	2.0	100
1N4573A	1.0	.001	.06	-55 to +100°C	2.0	100
1N4574	1.0	.0005	.03	0 to +75°C	2.0	100
1N4574A	1.0	.0005	.03	-55 to +100°C	2.0	100
1N4575	2.0	.01	.64	0 to +75°C	2.0	50
1N4575A	2.0	.01	.64	-55 to +100°C	2.0	50
1N4576	2.0	.005	.32	0 to +75°C	2.0	50
1N4576A	2.0	.005	.32	-55 to +100°C	2.0	50
1N4577	2.0	.002	.13	0 to +75°C	2.0	50
1N4577A	2.0	.002	.13	-55 to +100°C	2.0	50
1N4578	2.0	.001	.06	0 to +75°C	2.0	50
1N4578A	2.0	.001	.06	-55 to +100°C	2.0	50
1N4579	2.0	.0005	.03	0 to +75°C	2.0	50
1N4579A	2.0	.0005	.03	-55 to +100°C	2.0	50
1N4580	4.0	.01	.64	0 to +75°C	2.0	25
1N4580A	4.0	.01	.64	-55 to +100°C	2.0	25
1N4581	4.0	.005	.32	0 to +75°C	2.0	25
1N4581A	4.0	.005	.32	-55 to +100°C	2.0	25
1N4582	4.0	.002	.13	0 to +75°C	2.0	25
1N4582A	4.0	.002	.13	-55 to +100°C	2.0	25
1N4583	4.0	.001	.06	0 to +75°C	2.0	25
1N4583A	4.0	.001	.06	-55 to +100°C	2.0	25
1N4584	4.0	.0005	.03	0 to +75°C	2.0	25
1N4584A	4.0	.0005	.03	-55 to +100°C	2.0	25

\*JEDEC Registered Data.

**NOTES:**

1. When ordering devices with tighter tolerances than specified for the  $V_Z$  voltage nominal of 6.40V, add a hyphenated suffix to the part number for desired tolerance, e.g. 1N4569A-2%, 1N4574A-1-1%, 1N4579-1-2%, 1N4584A-1-3%, etc.
2. Zener impedance is measured by superimposing 0.75 mA ac rms on 7.5 mA dc @ 25°C.
3. Voltage measurements to be performed 15 seconds after application of dc test current  $I_{ZT}$ .
4. 1N4565 thru 1N4584 also have qualification to MIL-PRF-19500/452 by adding the JAN, JANTX, JANTXV, or JANS prefixes to part numbers as well as the "-1" suffix; e.g. JANTX1N4569A-1, JANTXV1N4574A-1, etc.
5. Designate Radiation Hardened devices with "RH" prefix instead of "1N," i.e., RH4584A.



**GRAPHS**

Typical change of Temperature Coefficient with change in Operating Current

Typical Change in Zener Voltage with change in Operating Current

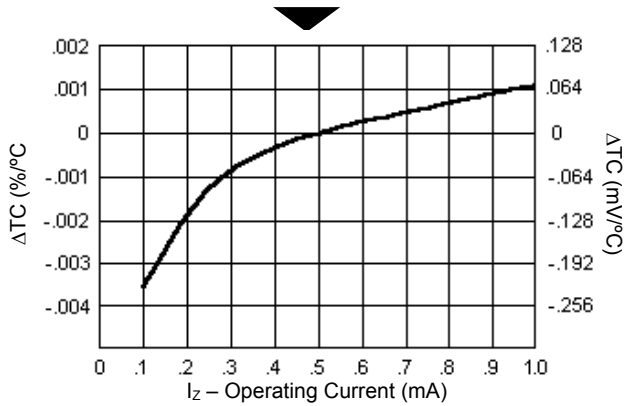

1N4565 – 1N4569A

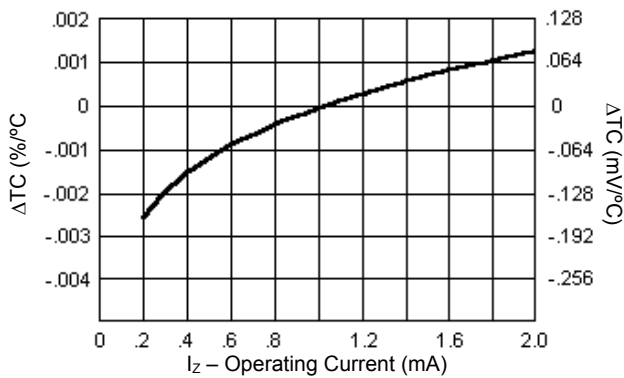
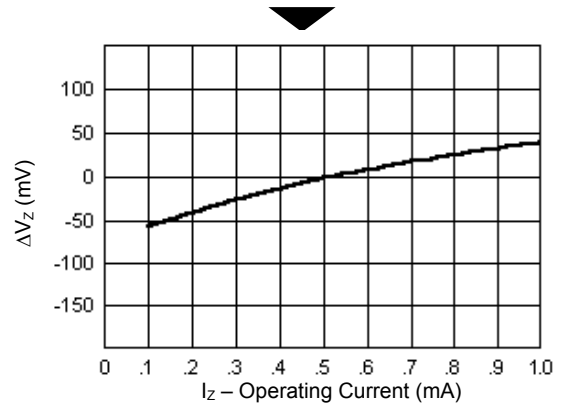

1N4570 – 1N4574A

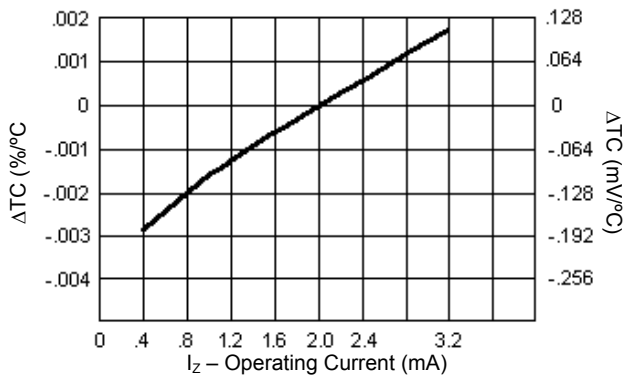
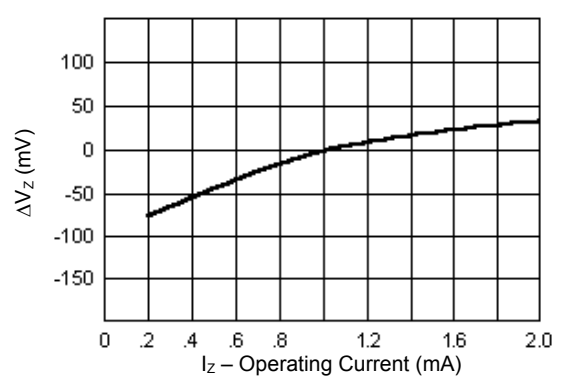

1N4575 – 1N4579A

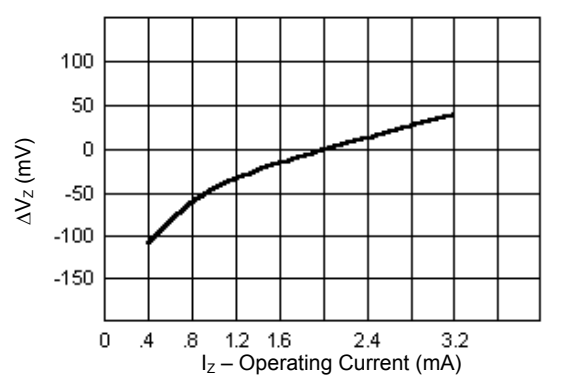

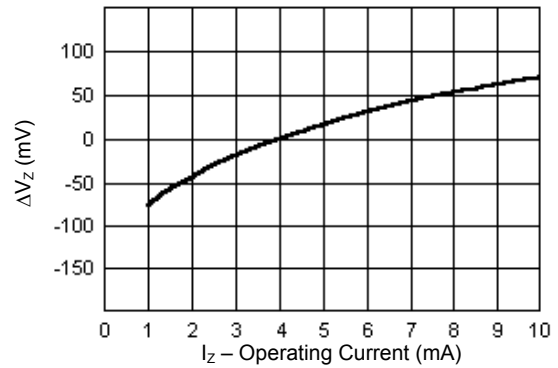
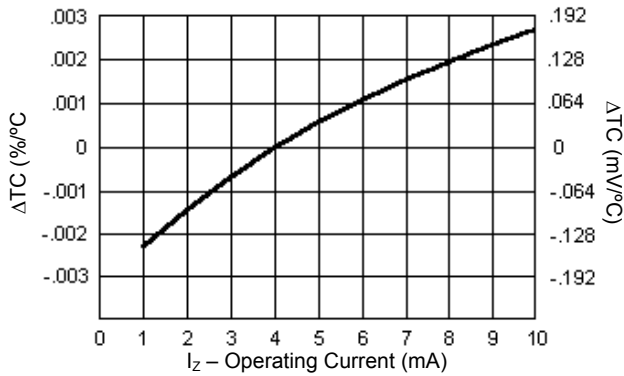

1N4580 – 1N4584A

**PACKAGE DIMENSIONS**

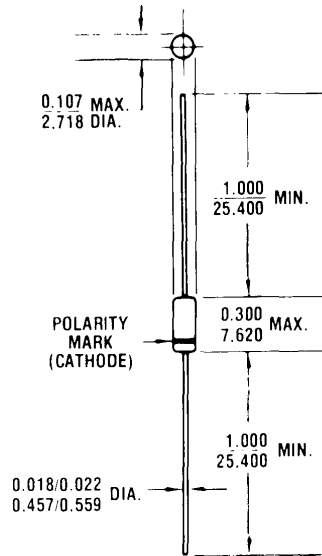

All dimensions in INCH  
mm