

Distinctive Characteristics

KP series offers a complete switch solution for all broadcast panel needs, including home keys and the custom rectangular switch/cap assembly.

Distinct, long total travel of .177" (4.5mm) for KP01 or shorter stroke of .138 (3.5mm) for KP02.

Available with red/green bicolor LED and custom RGB LEDs. The RGB LED full color spectrum in a switch package provides unlimited color combinations.

Specially designed snap-in standoff for simple and secure PC board mounting and alignment.

Unique actuation guide gives positive indication of circuit transfer as well as smooth and silent operation. (Patent pending).

Choices of tactile, nontactile or tactile/audible actuation.

Compact design with height of .906" (23.0mm) from PC board to top of cap. (Same height as IS series programmable SmartSwitch™.)

Flat, sculptured or home key square caps in three common sizes for design flexibility in audio/video applications.

Twin contacts with gold plating assure high reliability and long life of 5,000,000 operations minimum.

Epoxy sealed terminals to lock out flux, dust, and other contaminants, plus standard PCB spacing of .100" (2.54mm).



Actual Size

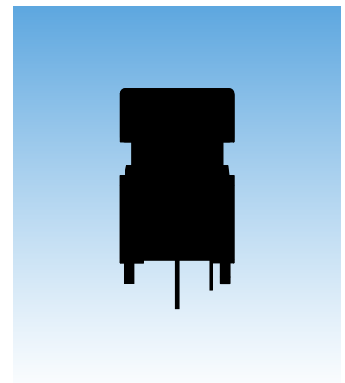

General Specifications

Electrical Capacity (Resistive Load)

Low Level: 100mA maximum @ 12V DC

Other Ratings

Contact Resistance:	200 milliohms maximum
Insulation Resistance:	100 megohms minimum @ 250V DC
Dielectric Strength:	1,000V AC minimum between contacts for 1 minute minimum 1,500V AC minimum between contacts & case for 1 minute minimum
Mechanical Life:	5,000,000 operations minimum; 1,000,000 operations minimum for custom Rectangular Switch/Cap Assembly (at center of cap)
Electrical Life:	5,000,000 operations minimum
Nominal Operating Force:	KP01: 1.9N maximum for Tactile & Nontactile models (at center of cap) KP02: 1.6N maximum for Tactile, Nontactile & Tactile/Audible models (at center of cap)
Travel:	KP01: Pretravel .122" (3.1mm); Overtravel .055" (1.4mm); Total Travel .177" (4.5mm) KP02: Pretravel .091" (2.3mm); Overtravel .047" (1.2mm); Total Travel .138" (3.5mm)

Materials & Finishes

Plunger/Upper Housing:	Polyacetal
Lower Housing:	Glass fiber reinforced PBT
Movable Contact:	Stainless steel with gold plating
Stationary Contacts:	Gold over copper alloy
Switch Terminals:	Brass with tin plating

Environmental Data

Operating Temp Range:	-25°C through +50°C (-13°F through +122°F)
Humidity:	90-95% humidity for 240 hours @ 40°C (104°F)
Vibration:	10 ~ 55Hz with peak-to-peak amplitude of 1.5mm traversing the frequency range & returning in 1 minute; 3 right angled directions for 2 hours
Shock:	51G (500m/s ²) acceleration (tested in 6 right angled directions, with 5 shocks in each direction)

Installation

Cap Installation Force : 50.0N maximum downward force on actuator

PCB Processing

Soldering:	Wave Soldering. See Profile A in Supplement section. Manual Soldering: See Profile A in Supplement section.
Cleaning:	These devices are not process sealed. Hand clean locally using alcohol based solution.

Standards & Certifications

UL Recognition or CSA Certification:	The KP Series pushbuttons have not been tested for UL recognition or CSA certification. These switches are designed for use in a low-voltage, low-current, logic-level circuit. When used as intended in a logic-level circuit, the results do not produce hazardous energy.
---	--

TYPICAL SWITCH ORDERING EXAMPLE

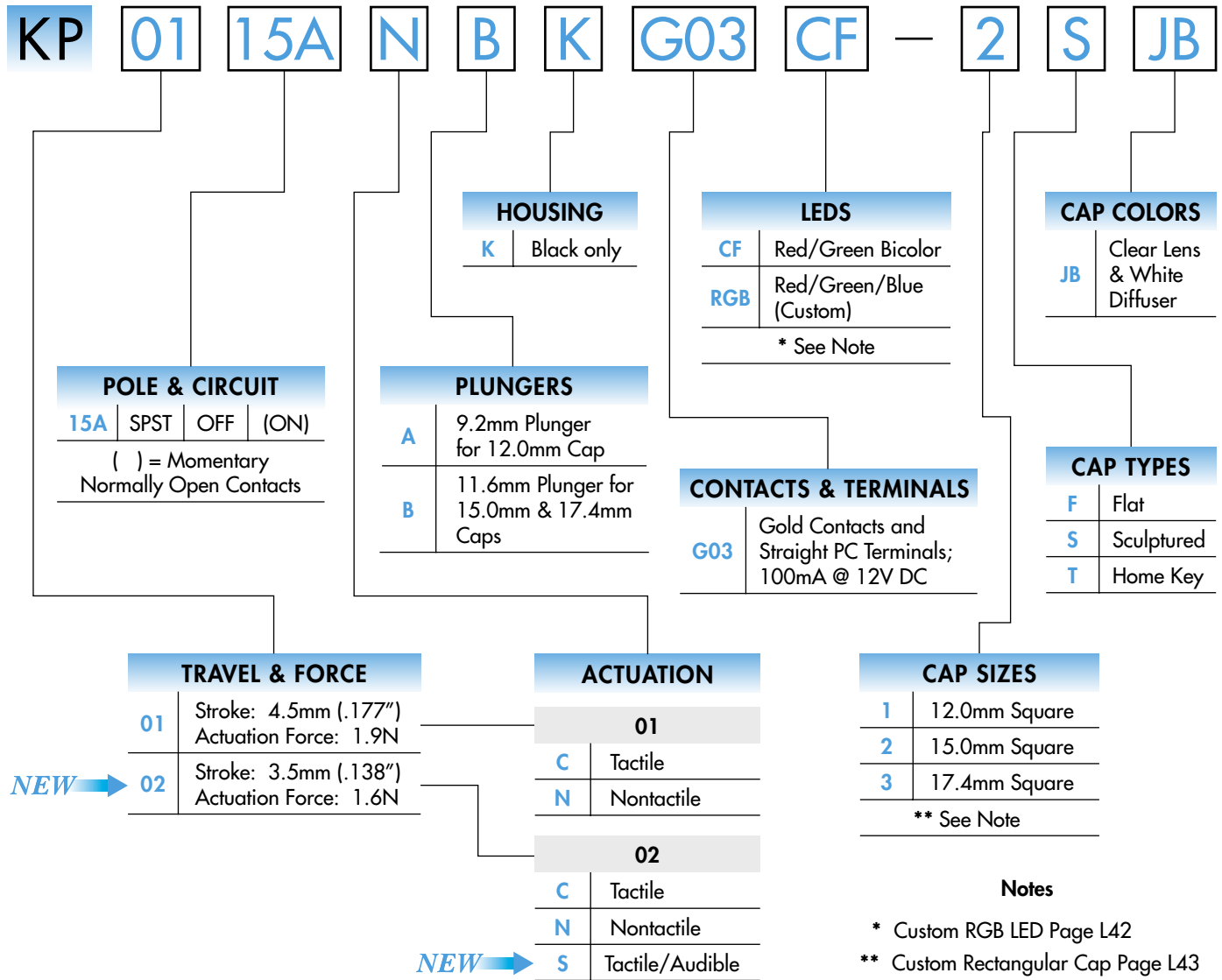









DESCRIPTION FOR TYPICAL ORDERING EXAMPLE

KP0115ANBKG03CF-2SJB

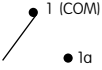

POLE & CIRCUIT

		Plunger Position () = Momentary		Connected Terminals		Throw & Switch Schematic
Pole	Model	Normal 	Down 	Normal 	Down 	Note: Switch terminals "1" & "1a" are actually marked on the switch. 
SP	KP0115A KP0215A	OFF 	(ON) 	Normally Open 	1-1a 	

ACTUATION

HOUSING



Tactile
KP01 or KP02



Nontactile
KP01 or KP02



← NEW
Tactile/Audible
KP02 only



Black only

CONTACTS, TERMINALS, & RATING





Gold Contacts

Straight PC Terminals

100mA @ 12V DC

BICOLOR LED SPECIFICATIONS

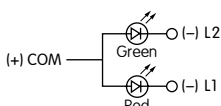
The electrical specifications shown are determined at a basic temperature of 25°C.

 <p>LEDs are an integral part of the switch and are not available separately.</p> <p>LED circuit is isolated and requires an external power source.</p> <p>If the source voltage exceeds the rated voltage, a ballast resistor is required.</p> <p>The resistor value can be calculated by using the formula in the Supplement section.</p>				Unit	
	Colors	Red	Green		
	Minimum Luminous Intensity	I_V	30	50	mcd
	Standard Luminous Intensity	I_V	60	115	mcd
	Forward Peak Current	I_{FM}	30 (25 for amber)	25 (22 for amber)	mA
	Continuous Forward Current	I_F	20	20	mA
	Forward Voltage	V_F	2.1	3.5	V
	Power Peak Dissipation	P_D	75	100	mW
	Reverse Peak Voltage	V_{RM}	4	4	V
	Wavelength at Peak Emission	λ	619 ~ 630	520 ~ 535	nm
Current Reduction Rate Above 25°C	ΔI_F	0.38	0.32	mA/°C	
Ambient Temperature Range		-25 ~ +50		°C	

Amber can be achieved by simultaneous illumination of Red & Green.

PLUNGERS

A 9.2mm Plunger for 12.0mm Cap

9.2mm Plunger is designed with a narrower neck to hold the 12.0mm Cap.

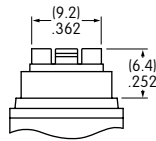

B 11.6mm Plunger for 15.0mm & 17.4mm Caps

11.6mm Plunger is designed with a wider neck to hold both the 15.0mm and 17.4mm Caps.

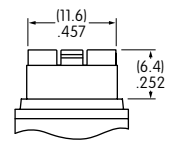

CAP TYPES & COLORS

1 12.0mm Square Used on A Plunger

F AT3083 Flat Cap

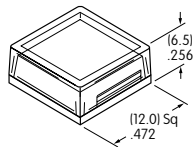

S AT3078 Sculptured Cap

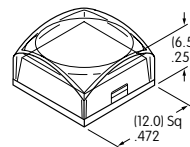

T AT3086 Home Key Cap

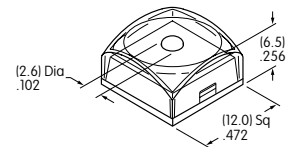

2 15.0mm Square Used on B Plunger

F AT3084 Flat Cap

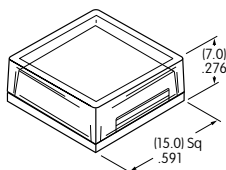

S AT3079 Sculptured Cap

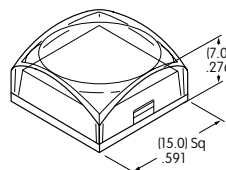

T AT3087 Home Key Cap

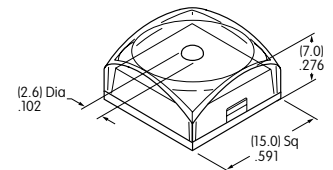

3 17.4mm Square Used on B Plunger

F AT3085 Flat Cap

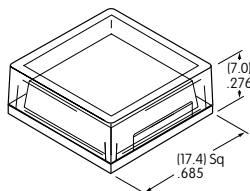

S AT3080 Sculptured Cap

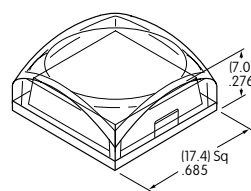

T AT3088 Home Key Cap

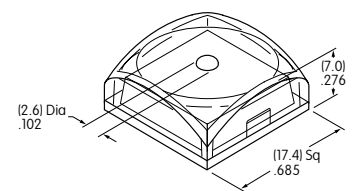

JB Lens & Diffuser Colors Available: Clear/White

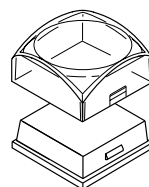

Clear Lens

White Diffuser

Materials & Finishes: Lens - Polycarbonate with glossy finish; Diffuser - Polycarbonate with textured finish

Optional Protective Guard AT4170 available; contact factory.

TYPICAL SWITCH DIMENSIONS

12.0mm Square Cap

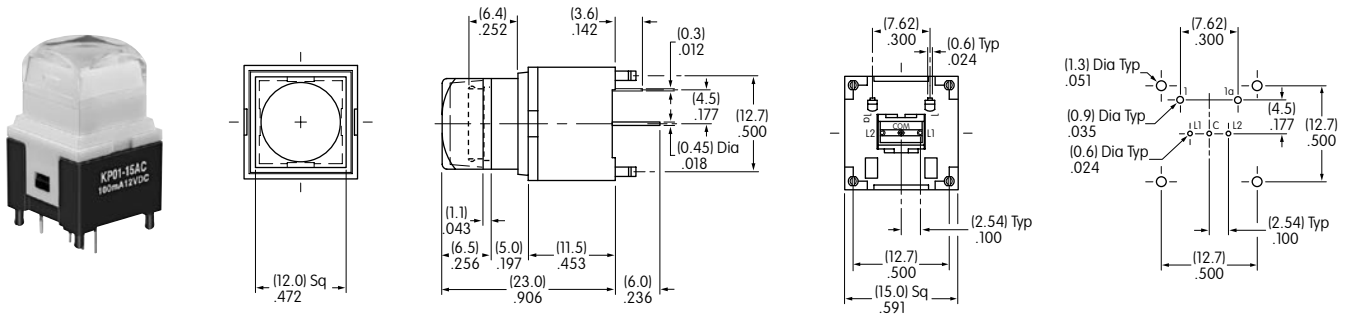

KP0115ACAKG03CF-1SJB

15.0mm Square Cap

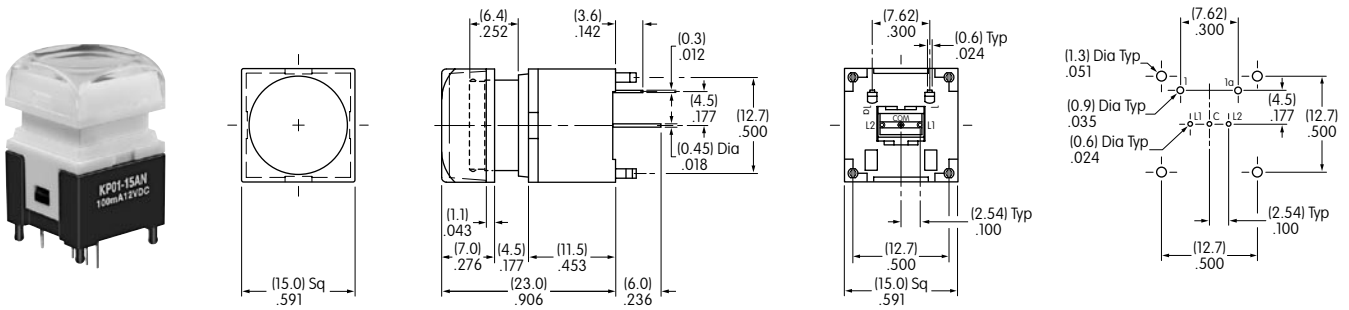

KP0115ANBKG03CF-2SJB

17.4mm Square Cap

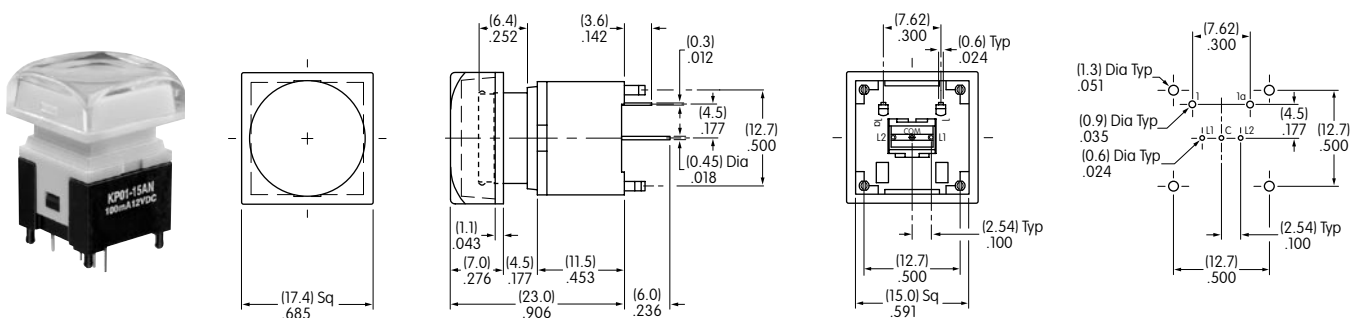

KP0115ANBKG03CF-3SJB

CUSTOM RGB

LED SPECIFICATIONS

The electrical specifications shown are determined at a basic temperature of 25°C.

LEDs are an integral part of the switch and are not available separately.

LED circuit is isolated and requires an external power source.

If the source voltage exceeds the rated voltage, a ballast resistor is required.

The resistor value can be calculated by using the formula in the Supplement Section.

Note: For applications that require white illumination, contact factory.

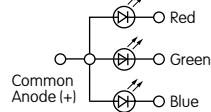

RGB

	Color	Red	Green	Blue	Unit
Forward Peak Current	I_{FM}	30	30	30	mA
Continuous Forward Current	I_F	20	15	15	mA
Forward Voltage	V_F	2.0	3.3	3.4	V
Power Peak Dissipation	P_D	40	80	80	mW
Reverse Peak Voltage	V_{RM}	5	5	5	V
Dominant Wavelength	λ_d	625	525	470	nm
Current Reduction Rate Above 25°C	Δ_{IF}	0.50	0.50	0.50	mA/°C
Ambient Temperature Range		-25 ~ +50			°C

TYPICAL SWITCH DIMENSIONS

12.0mm Square Cap with RGB LED

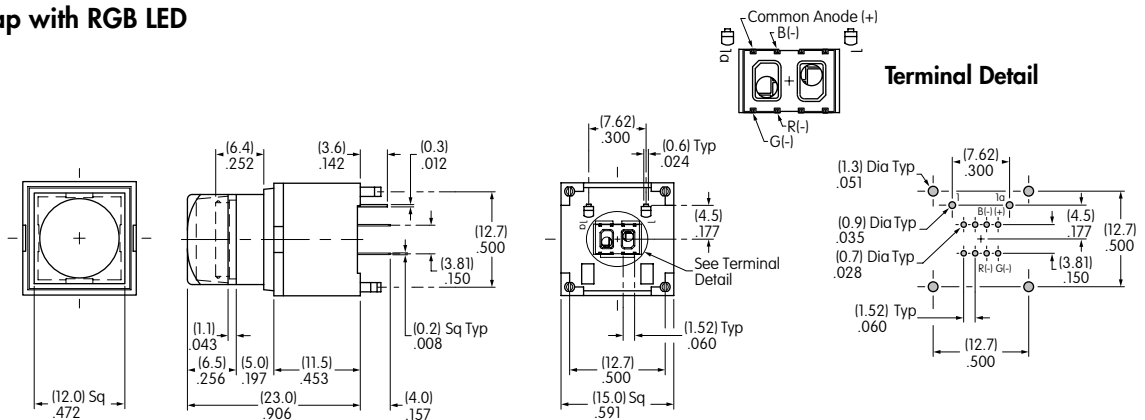

KP0115ACAKG03RGB-1SJB

15.0mm & 17.4mm Square Caps with RGB LED

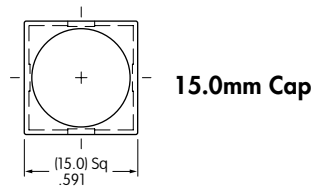

15.0mm Cap

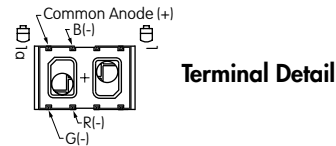

Terminal Detail

KP0115ANBKG03RGB-2SJB

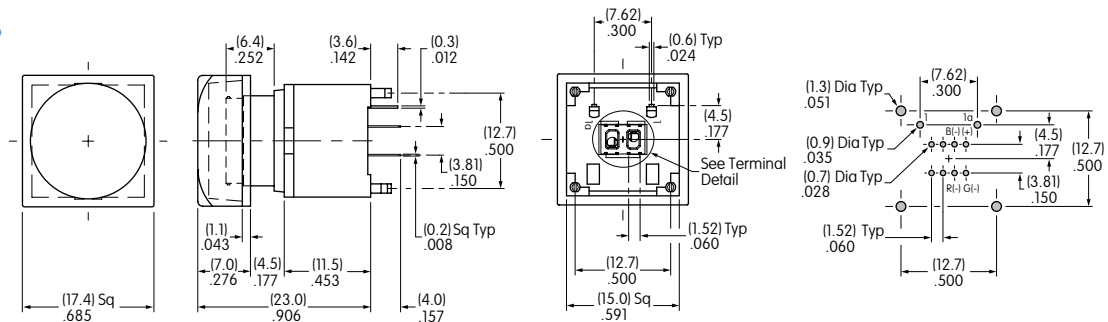

17.4mm Cap

KP0115ANBKG03RGB-3SJB

CUSTOM RECTANGULAR CAP ASSEMBLY

CAP ASSEMBLY DIMENSIONS

Switch/Rectangular Cap Assembly

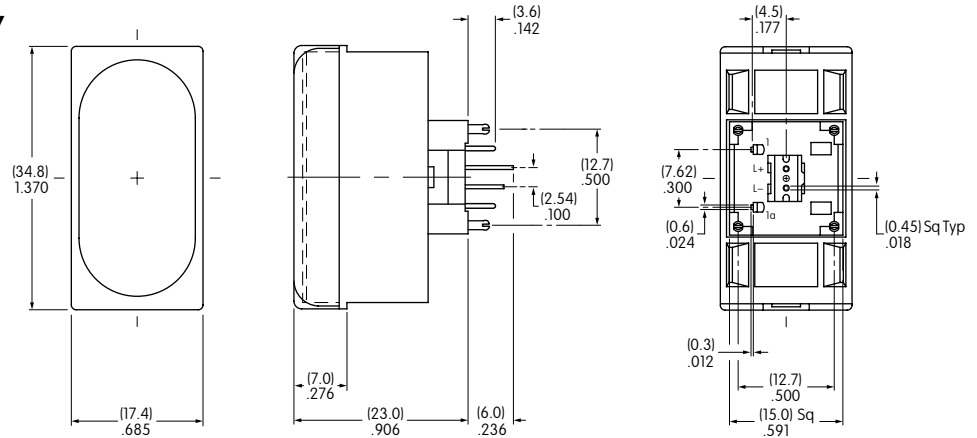

KP0115ACBKG03CJB for Tactile
 KP0115ANBKG03CJB for Nontactile

See below for complete assembly of switch, LEDs and LED holders.

LED SPECIFICATIONS

The electrical specifications shown are determined at a basic temperature of 25°C. Center LED is an integral part of the switch. LEDs are not sold separately. LED circuits are isolated and require an external power source. If the source voltage exceeds the rated voltage, a ballast resistor is required. The resistor value can be calculated by using the formula in the Supplement Section.

	Color	Red	Unit
Forward Peak Current	I_{FM}	30	mA
Continuous Forward Current	I_F	20	mA
Forward Voltage	V_F	2.0	V
Reverse Peak Voltage	V_{RM}	4	V
Dominant Wavelength	λ_d	623	nm
Current Reduction Rate Above 25°C	ΔI_F	0.32	mA/°C
Ambient Temperature Range		-25 ~ +50	°C

Contact factory for other LED colors.

ASSEMBLY & INSTALLATION INSTRUCTIONS

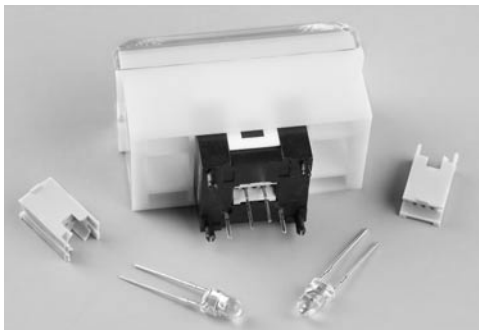

Switch/Rectangular Cap assembly has 3 LEDs to achieve bright and even illumination.

One LED (in center of switch bottom) is an integral part of the switch; the other 2 LEDs and 2 LED Holders are packaged separately.

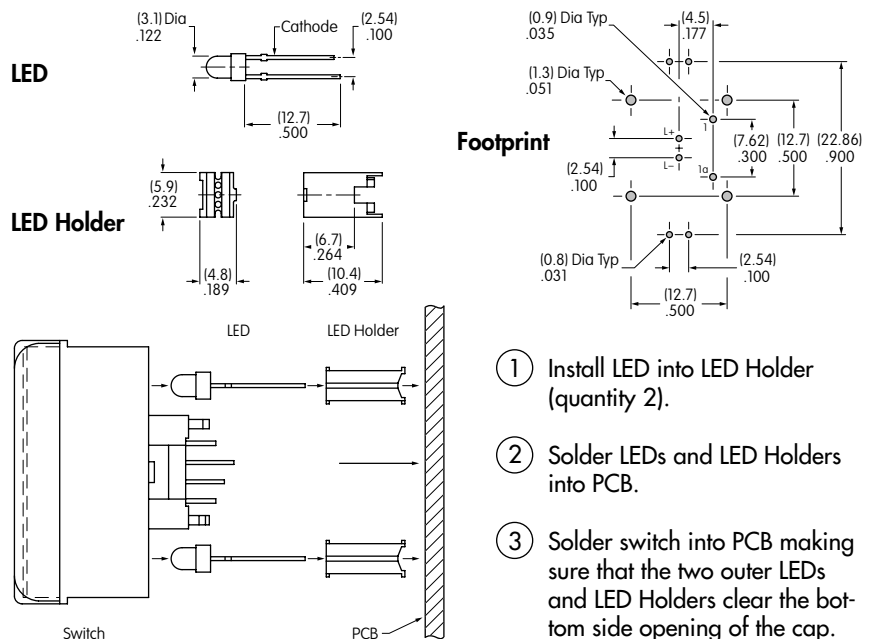

- ① Install LED into LED Holder (quantity 2).
- ② Solder LEDs and LED Holders into PCB.
- ③ Solder switch into PCB making sure that the two outer LEDs and LED Holders clear the bottom side opening of the cap.

ASSEMBLY INSTRUCTIONS FOR SQUARE CAPS



Cap Orientation

As shown in the accompanying illustration, the cap and plunger are designed with tabs and notches to assure proper orientation of the cap on the switch.

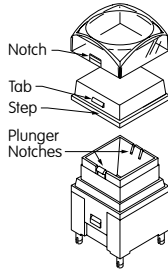

Removal of Cap Assembly & Separation of Lens & Diffuser

Holding the switch tightly, pull the cap off the switch. Once the cap assembly is released from the plunger, the lens and diffuser can be separated.

Pry up the lens with fingernail or flat tip screwdriver inserted at the step on the diffuser.

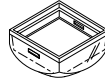

Installation or Replacement of Cap

After aligning notches with tabs, join the lens and diffuser. Hold the switch tightly without touching the terminals. Firmly press the cap onto the plunger by applying pressure from one side to the other until both are snapped together.

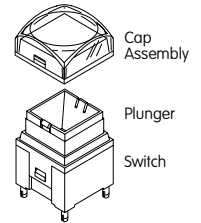

LEGENDS

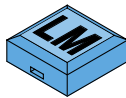

Easily create and submit your own legends using our new on-line Legend Maker.

Visit www.nkkswitches.com

For other legend support options, customers may contact the factory or utilize the general information and basic specifications presented below.

Recommended Methods:

- Laser Etch, Screen Print, or Pad Print on lens;
- Screen Print on film insert.
- Epoxy based ink is recommended.

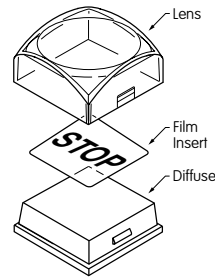

Printing on Diffuser is not advisable.

Shaded areas are suggested printable areas for Lens & Film Insert.

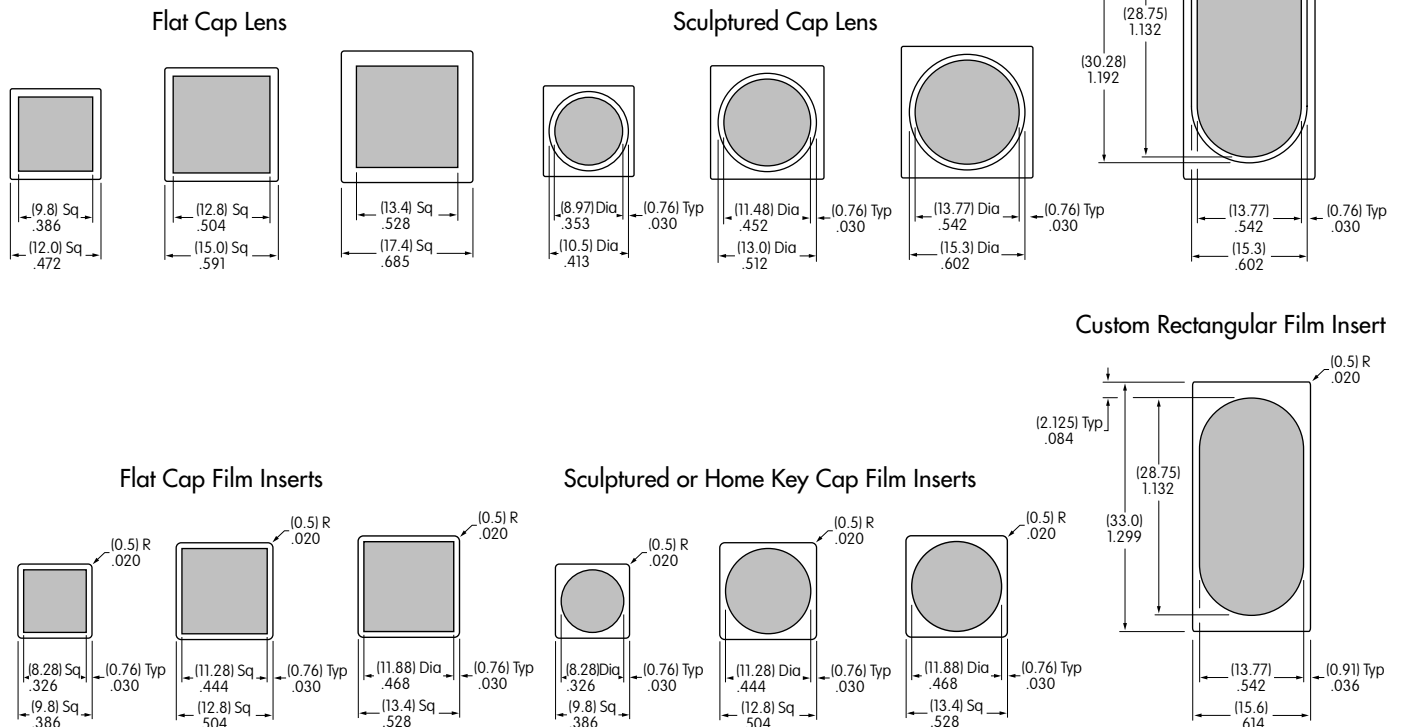

Film Insert Material and Thickness: Clear Polyester; 4 mil (100µ) maximum thickness