

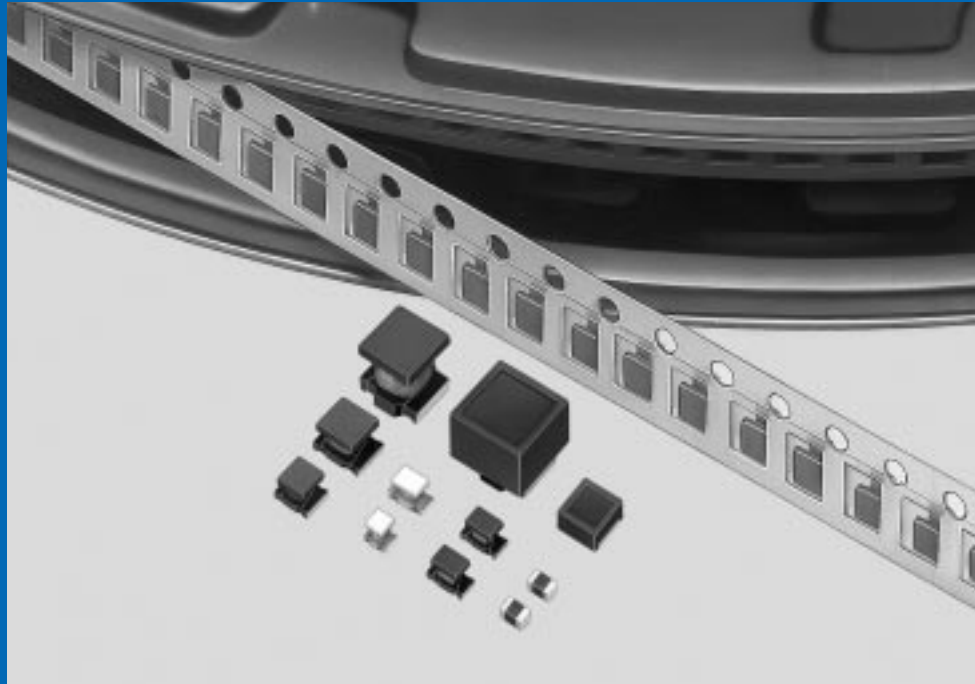

CHIP COIL

CHIP COIL

























*Innovator
in Electronics*

Murata
Manufacturing Co., Ltd.

Murata's LQ□ series of chip coils consists of compact, high-performance inductors. Their innovative coil and case structures mean low DC resistance and outstanding

high-frequency characteristics. The series is designed for a variety of applications, facilitating component selection for individual circuit requirements.

■PRODUCTS GUIDE

Application	Part Number	Structure	Dimensions		Inductance Range (H)							Page			
			(mm)	(inch)	1n	10n	100n	1μ	10μ	100μ	1m		10m		
General Frequency Range	LQH1N	Wound coil (ferrite core)		1206										3-7	
	LQH3N			1210											
	LQH (N) 4N			1812											
	LQG11N	Magnetically shielded multilayer		0603										8-9	
	LQG21N			0805										10-11	
Tight inductance tolerance	LQS33N	Magnetically shielded		1214										12-13	
High-frequency Range	LQG10A	Multilayer		0402										14-16	
	LQG11A			0603											
	Tight inductance tolerance	LQP10A	Thin film		0402										17-20
		LQP11A			0603										
	LQW1608A	Wound coil (air core)		0603										21-23	
	LQN21A			0805										24-27	
	LQN1A			1206											
	LQN1H			1206											28
Chokes	LQH1C	Wound coil		1206										29-31	
	LQH3C			1210											
	LQH4C			1812											
	LQG21C	Magnetically shielded multilayer		0805										32	
	LQG21F			0805										33-34	
	LQG3216F			1206											
	LQN6C		Wound coil		2220										39-41
	LQS33C	Magnetically shielded		1212										37-38	
	LQS66C			2525											39-41

Please refer to the usage conditions;

- Notice of Chip CoilP.42—P.45
- Design KitP.47—P.50
- Dimensions of TapingP.46
- Information of Chip CoilP.51

■PART NUMBERING

(Please specify the part number when ordering.)

(Ex.)

LQ	H	3	N	331	K	34
----	---	---	---	-----	---	----

① ② ③ ④ ⑤ ⑥ ⑦

LQ	N	21	A	10N	J	04
----	---	----	---	-----	---	----

① ② ③ ④ ⑤ ⑥ ⑦

LQ	G	21	N	R10	K	10	T1
----	---	----	---	-----	---	----	----

① ② ③ ④ ⑤ ⑥ ⑦ ⑧

① Chip Coil

② Form · Structure

Mark	Form · Structure
H	Wire wound with coating
N	Wire wound without coating
S	Wire wound with shielded core
P	Thin film
G	Multilayer
W	Horizontal wire wound

③ Size

Mark	Size
1	3.2X1.6mm
3	3.2X2.5mm
4	4.5X3.2mm
6	5.7X5.0mm
10	1.0X0.5mm
11	1.6X0.8mm
21	2.0X1.25 (1.5) mm
33	3.2X3.5mm, 3.3X3.3mm
66	6.3X6.3mm
1608	1.6X0.8mm
3216	3.2X1.6mm

④ Characteristic · Applications

Mark	Characteristic · Applications
N	General use
C	Choke coil
A	Air coil
H	High Q
F	For DC power supply line choke coil

⑤ Inductance

Example : 330 μ H→331 33nH→33N
 33 μ H→330 3.3nH→3N3
 3.3 μ H→3R3
 0.33 μ H→R33

⑥ Inductance Tolerance

Mark	Tolerance
G	± 2%
J	± 5%
K	±10%
M	±20%
N	±30%
B	±0.1nH
C	±0.2nH
S	±0.3nH
D	±0.5nH

⑦ Additional Number

⑧ Packaging Code

(LQG21N/21C/LQP10A/11A/
 LQG10A/11A/LQW1608A)

Mark	Packaging
T1	Taped (ϕ 180mm Reel)
T2	Taped (ϕ 330mm Reel)
B1	Bulk package

CHIP INDUCTOR SELECTION

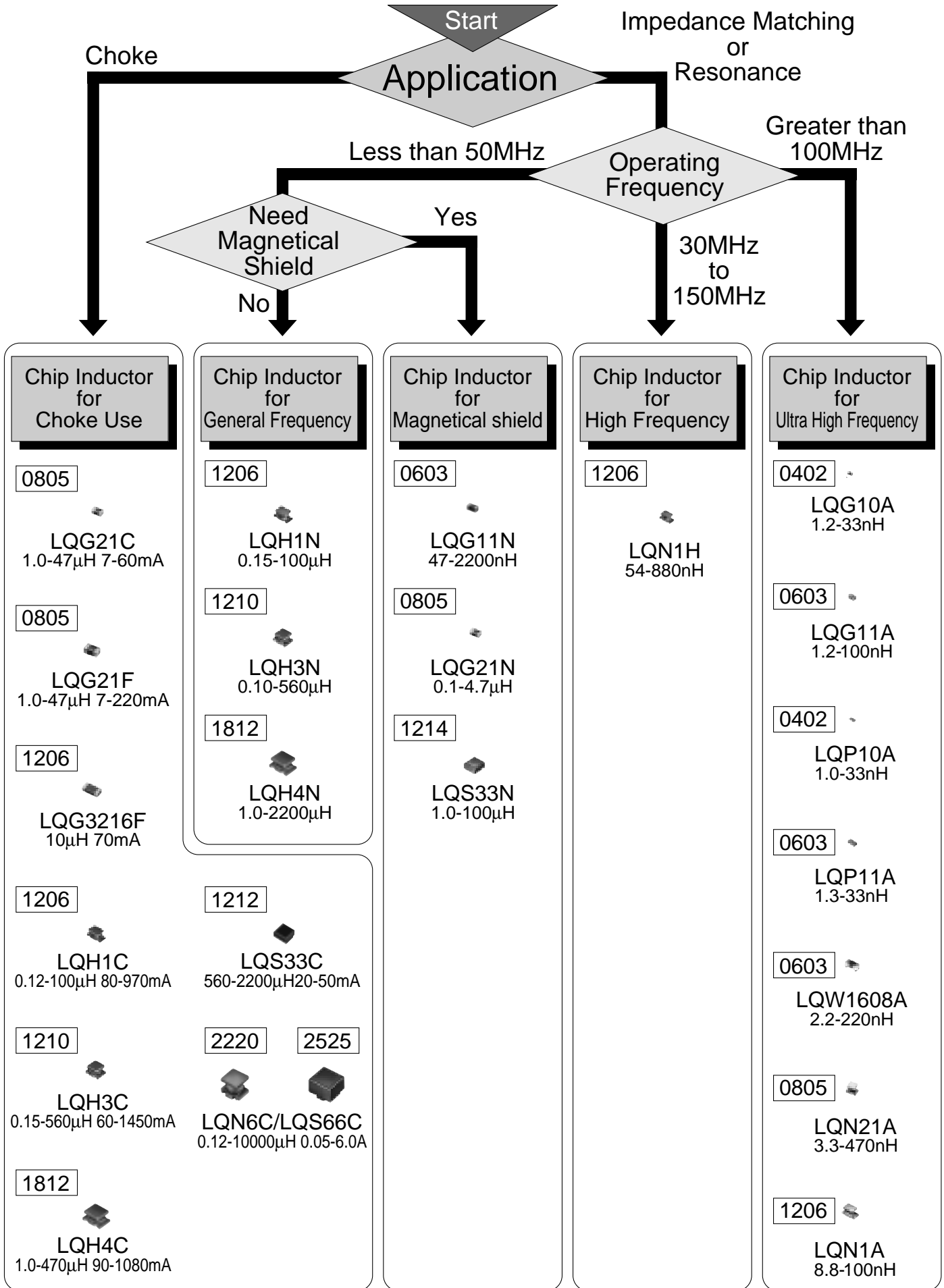

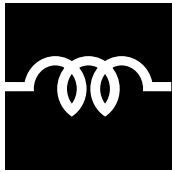

CHIP COIL



Standard Chip Coil **LQH1N/LQH3N/LQH(N)4N** Series

Wire Wound Chip Coil with High Q Value at High Frequencies and Low DC Resistance

The chip coil LQH/LQN series consists of miniature chip inductors wound on a special ferrite core and are made possible by an automatic winding technique developed by Murata. These inductors have a high Q at high frequencies and low DC resistance, making them very well suited to enhancing the performance of electronic circuits in video, communications, and audio equipment.

FEATURES

1. There are three different inductor types: the LQH1N, LQH3N and LQH(N)4N series. These three series cover a wide inductance range (from 0.1μH to 2.2mH).
2. The series has outstanding frequency characteristics and a high Q value at high frequencies.
3. The low DC resistance permits high current flow.
4. The series has excellent solder heat resistance. Both flow and reflow soldering methods can be employed.

● LQH1N

Miniature size (3.2×1.6×1.8mm) allows parallel mounting at 2.5mm pitch. The series is suitable for portable audio-visual equipment.

● LQH3N

A high Q value makes this series suitable for circuits up to 100MHz in frequency. The series is excellent for video equipment.

● LQH(N)4N

This series offers high inductance values and high current capacity. At 10μH, up to 450mA designs are possible, resulting in excellent performance when the inductors are used as choke coils.

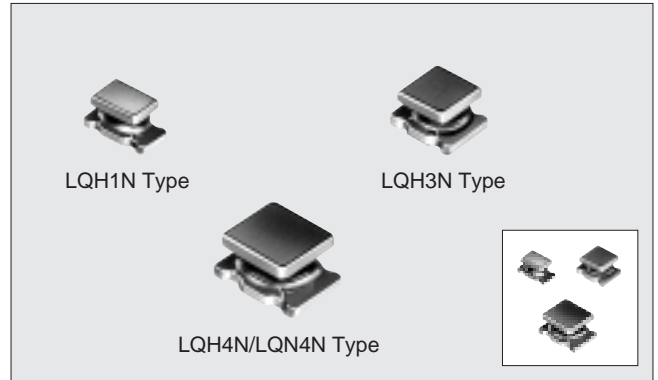

DIMENSIONS

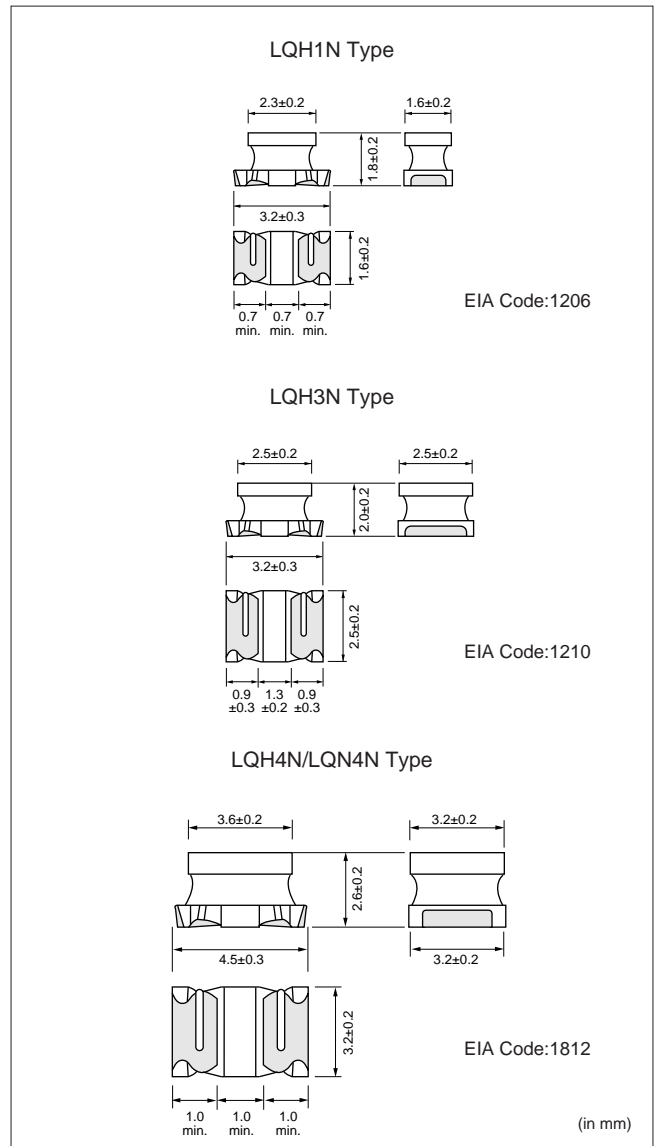

■SPECIFICATIONS

LQH1N

Part Number	Inductance			Q		DC Resistance (Ω)	Self-resonant Frequency (MHz min.)	Allowable Current (mA)	Operating Temp. Range			
	Nominal Value(μH)	Tolerance (%)	Test Frequency	Nominal Value(min.)	Test Frequency							
LQH1NR15K04	0.15	±10	1MHz	20	25MHz	0.39±40%	250	250	-25 to +85°C			
LQH1NR22K04	0.22					0.43±40%		240				
LQH1NR33K04	0.33					0.45±40%		230				
LQH1NR47K04	0.47					0.83±40%		215				
LQH1NR56K04	0.56			0.61±40%		200						
LQH1NR68K04	0.68			0.67±40%		180						
LQH1NR82K04	0.82			0.73±40%		160						
LQH1NR82K04	0.82			0.73±40%		120						
LQH1N1R0K04	1.0	±10	1MHz	30	10MHz	0.49±30%	100	175				
LQH1N1R2K04	1.2					0.9 ±30%	90	165				
LQH1N1R5K(J)04	1.5			1.0 ±30%		75	155					
LQH1N1R8K(J)04	1.8			1.6 ±30%		60	150					
LQH1N2R2K(J)04	2.2			0.7 ±30%		50	140					
LQH1N2R7K(J)04	2.7			0.55±30%		43	135					
LQH1N3R3K(J)04	3.3			±10 (±5)		1MHz	35	8MHz		0.61±30%	38	130
LQH1N3R9K(J)04	3.9									1.5 ±30%	35	125
LQH1N4R7K(J)04	4.7									1.7 ±30%	31	120
LQH1N5R6K(J)04	5.6									1.8 ±30%	28	115
LQH1N6R8K(J)04	6.8	2.0 ±30%	25		110							
LQH1N8R2K(J)04	8.2	2.2 ±30%	23		105							
LQH1N100K(J)04	10	2.5 ±30%	20		100							
LQH1N120K(J)04	12	2.7 ±30%	18		95							
LQH1N150K(J)04	15	±10 (±5)	1MHz	40	5MHz	3.0 ±30%	16	90				
LQH1N180K(J)04	18					3.4 ±30%	15	85				
LQH1N220K(J)04	22			3.1 ±30%		14	85					
LQH1N270K(J)04	27			3.4 ±30%		13	80					
LQH1N330K(J)04	33			3.8 ±30%		12	80					
LQH1N390K(J)04	39			7.2 ±30%		11	55					
LQH1N470K(J)04	47			8.0 ±30%		10	55					
LQH1N560K(J)04	56			8.9 ±30%		9.0	50					
LQH1N680K(J)04	68			9.9 ±30%		8.5	50					
LQH1N820K(J)04	82			11 ±30%		7.5	45					
LQH1N101K(J)04	100	12 ±30%	7.0	45								

LQH3N

Part Number	Inductance			Q		DC Resistance (Ωmax.)	Self-resonant Frequency (MHz min.)	Allowable Current (mA)	Operating Temp. Range
	Nominal Value(μH)	Tolerance (%)	Test Frequency	Nominal Value(min.)	Test Frequency				
LQH3NR10M34	0.10	±20	1MHz	20	25.2MHz	0.25	200	700	-25 to +85°C
LQH3NR18M34	0.18							650	
LQH3NR27M34	0.27			600					
LQH3NR39M34	0.39							530	
LQH3NR56M34	0.56			160					
LQH3NR68M34	0.68							470	
LQH3NR82M34	0.82			120					
LQH3N1R0M34	1.0							100	
LQH3N1R2M34	1.2			425					
LQH3N1R5K34	1.5							±10	
LQH3N1R8K34	1.8	0.6	400						
LQH3N2R2K34	2.2	0.7	390						
LQH3N2R7K34	2.7	0.8	370						
LQH3N3R3K34	3.3	0.9	320						
LQH3N3R9K34	3.9	1.0	300						
LQH3N4R7K34	4.7	1.1	290						
LQH3N5R6K34	5.6	1.2	270						
LQH3N6R8K34	6.8	1.3	250						
LQH3N8R2K34	8.2	1.5	240						
LQH3N100K(J)34	10	±10 (±5)	35	1MHz	1.6	11	225		
LQH3N120K(J)34	12				1.8		190		
LQH3N150K(J)34	15				2.0		180		
LQH3N180K(J)34	18				2.2		170		
LQH3N220K(J)34	22				2.5		165		
LQH3N270K(J)34	27				2.8		150		
LQH3N330K(J)34	33				3.1		125		
LQH3N390K(J)34	39				3.5		115		
LQH3N470K(J)34	47				3.9		110		
LQH3N560K(J)34	56				4.3		100		
LQH3N680K(J)34	68	4.9	85						
LQH3N820K(J)34	82	5.5	80						
LQH3N101K(J)34	100	40	796kHz	1MHz	6.2	8.0	70		
LQH3N121K(J)34	120				7.0		80		
LQH3N151K(J)34	150				8.0		75		
LQH3N181K(J)34	180				9.3		70		
LQH3N221K(J)34	220				10.2		65		
LQH3N271K(J)34	270				11.8				
LQH3N331K(J)34	330				12.5		5.0		
LQH3N391K(J)34	390				13.0				
LQH3N471K(J)34	470				22.0		50		
LQH3N561K(J)34	560				25.0		45		
		28.0	40						

LQH4N/LQN4N

Part Number	Inductance			Q		DC Resistance (Ωmax.)	Self-resonant Frequency (MHz min.)	Allowable Current (mA)	Operating Temp. Range		
	Nominal Value(μH)	Tolerance (%)	Test Frequency	Nominal Value(min.)	Test Frequency						
LQH4N1R0M04	1.0	±20	1MHz	20	1MHz	0.20	120	500	-25 to +85°C		
LQH4N1R2M04	1.2						100				
LQH4N1R5M04	1.5					0.30	85				
LQH4N1R8M04	1.8						75				
LQH4N2R2M04	2.2					0.32	62				
LQH4N2R7M04	2.7						53				
LQH4N3R3M04	3.3					0.35	47				
LQH4N3R9M04	3.9					0.38	41				
LQH4N4R7K04	4.7	±10		30		0.40	38				
LQH4N5R6K04	5.6					0.47	33				
LQH4N6R8K04	6.8					0.50	31				
LQH4N8R2K04	8.2					0.56	27				
LQH4N100K(J)04	10	±10 (±5)		35		40	796kHz	0.62		23	400
LQH4N120K(J)04	12							0.73		21	380
LQH4N150K(J)04	15							0.82		19	360
LQH4N180K(J)04	18							0.94		17	340
LQH4N220K(J)04	22							1.1		15	320
LQH4N270K(J)04	27							1.2		14	300
LQH4N330K(J)04	33							1.4		12	270
LQH4N390K(J)04	39							1.5		11	240
LQH4N470K(J)04	47							1.7		10	220
LQH4N560K(J)04	56							1.9		9.3	200
LQH4N680K(J)04	68							2.2		8.4	180
LQH4N820K(J)04	82							2.5		7.5	170
LQH4N101K(J)04	100		40		1kHz			252kHz	2.5	6.8	160
LQH4N121K(J)04	120								3.0	6.2	150
LQH4N151K(J)04	150								3.7	5.5	130
LQH4N181K(J)04	180								4.5	5.0	120
LQH4N221K(J)04	220	5.4		4.5		110					
LQH4N271K(J)04	270	6.8		4.0		100					
LQH4N331K(J)04	330	8.2		3.6		95					
LQH4N391K(J)04	390	9.7		3.3		90					
LQH4N471K(J)04	470	11.8		3.0		80					
LQH4N561K(J)04	560	14.5		2.7		70					
LQH4N681K(J)04	680	17.0	2.5	65							
LQH4N821K(J)04	820	20.5	2.2	60							
LQH4N102K(J)04	1000	252kHz	1kHz	252kHz	25.0	2.0	50				
LQH4N122K(J)04	1200				30.0	1.8	45				
LQH4N152K(J)04	1500				37.0	1.6	40				
LQN4N182K(J)04	1800				45.0	1.5	35				
LQN4N222K(J)04	2200				50.0	1.3	30				

■ TYPICAL ELECTRICAL CHARACTERISTICS

● Q - Frequency Characteristics

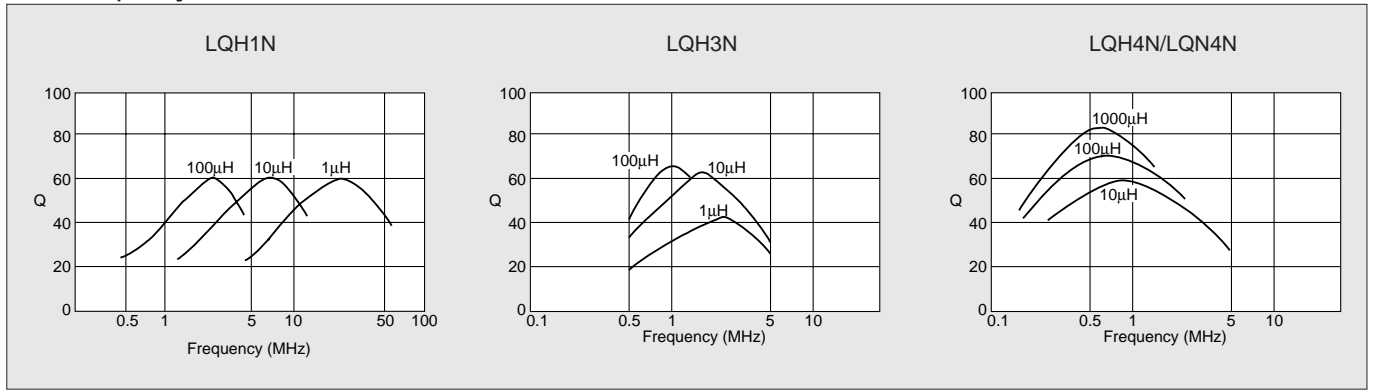

● Inductance - Temperature Characteristics

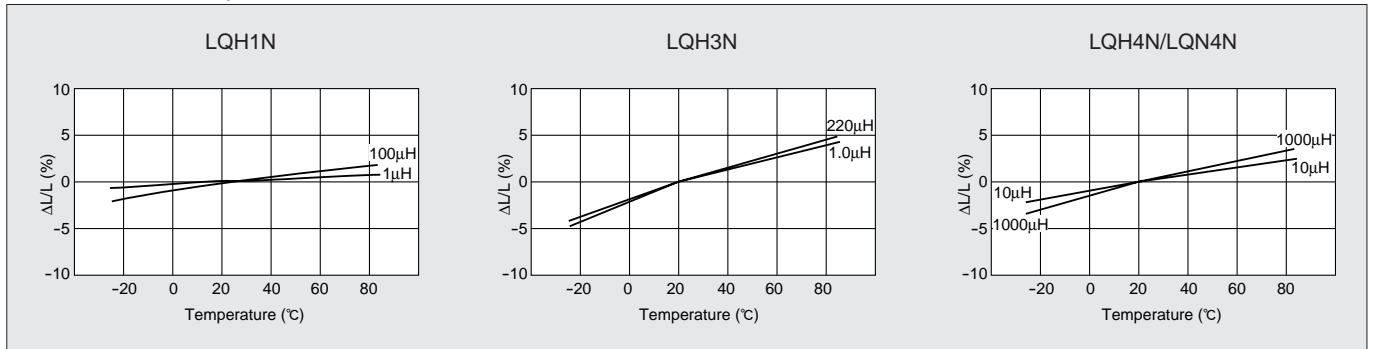

● Inductance - Current Characteristics

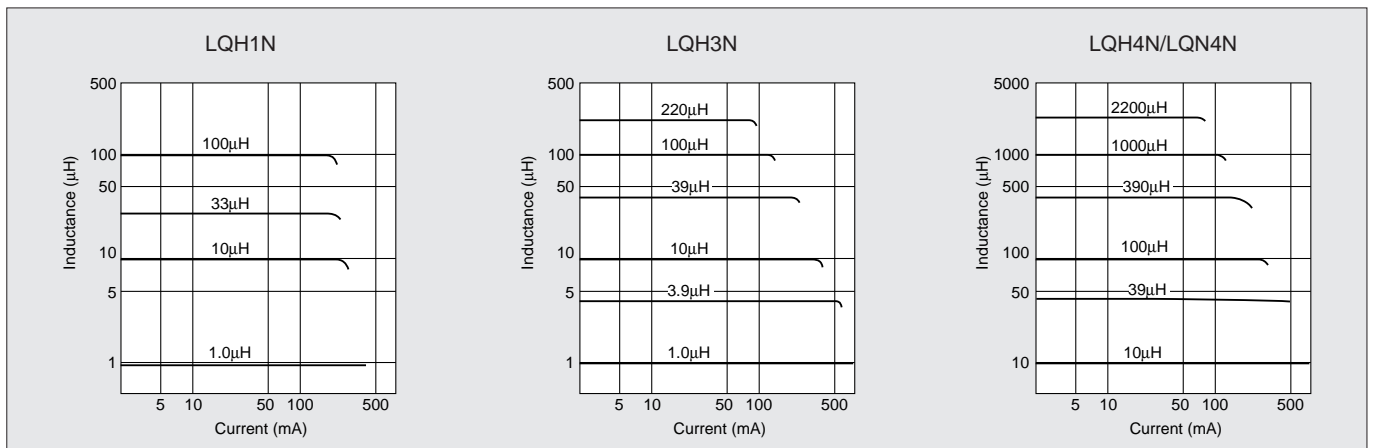

● Coupling Coefficient

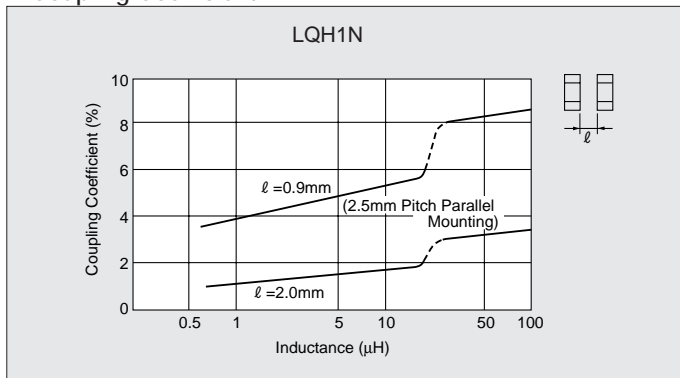

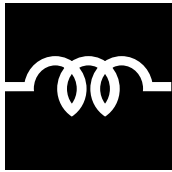

CHIP COIL



Multilayer Chip Inductor LQG11N Series

Magnetically Shielded Multilayer Chip Coil Excellent for High Density Mounting

The LQG11N series, of magnetically shielded chip coil was developed by using original multilayer process technology and magnetic materials.

Compact size is suitable for high density mounting. Shielded construction is not affected by interference from peripheral components.

■FEATURES

1. Magnetically shielded structure provides excellent characteristics in cross talk and magnetic coupling.
2. Compact size (1.6X0.8mm) and light weight.
3. The external electrodes with nickel barrier structure provide excellent solder heat resistance. Both flow and reflow soldering can be applicable.

■APPLICATIONS

- Resonance circuit, traps, filter circuits and RF choke in telecommunication equipments, cordless phones, radio equipments.

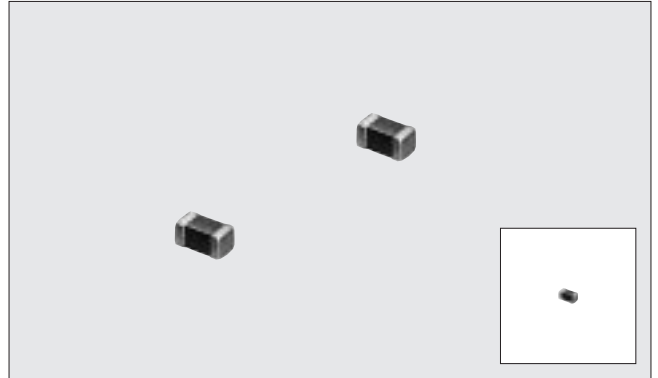

■DIMENSIONS

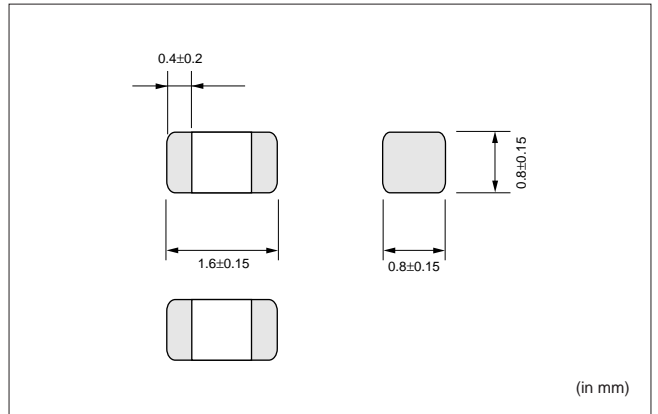

■ SPECIFICATIONS

Part Number	Inductance		Q		DC Resistance (Ω max.)	Self-resonant Frequency (MHz min.)	Allowable Current (mA)	Operating Temp. Range
	Nominal Value (nH)	Tolerance (%)	Nominal Value(min.)	Test Frequency (MHz)				
LQG11N47NM00	47	±20	10	50	0.30	260	50	-25 to +85°C
LQG11N68NM00	68					250		
LQG11N82NM00	82					245		
LQG11NR10K00	100	±10	15	25	0.50	240		
LQG11NR12K00	120					205		
LQG11NR15K00	150				0.60	180		
LQG11NR18K00	180					165		
LQG11NR22K00	220				0.80	150		
LQG11NR27K00	270					136		
LQG11NR33K00	330				0.85	125		
LQG11NR39K00	390				1.00	110		
LQG11NR47K00	470				1.35	105		
LQG11NR56K00	560				1.55	95		
LQG11NR68K00	680	1.70	90					
LQG11NR82K00	820	2.10	85					
LQG11N1R0K00	1000	±10	35	10	0.60	75	25	
LQG11N1R2K00	1200				0.80	65		
LQG11N1R5K00	1500					60		
LQG11N1R8K00	1800				0.95	55		
LQG11N2R2K00	2200				1.15	50		

■ TYPICAL ELECTRICAL CHARACTERISTICS

● Q-Frequency Characteristics

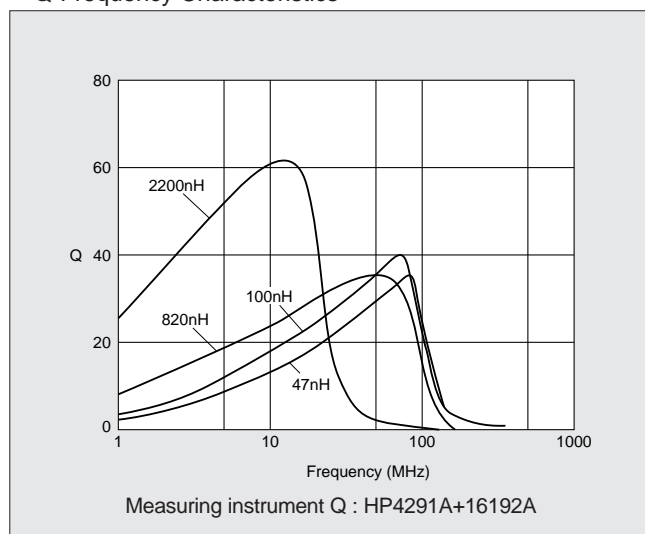

● Inductance-Frequency Characteristics

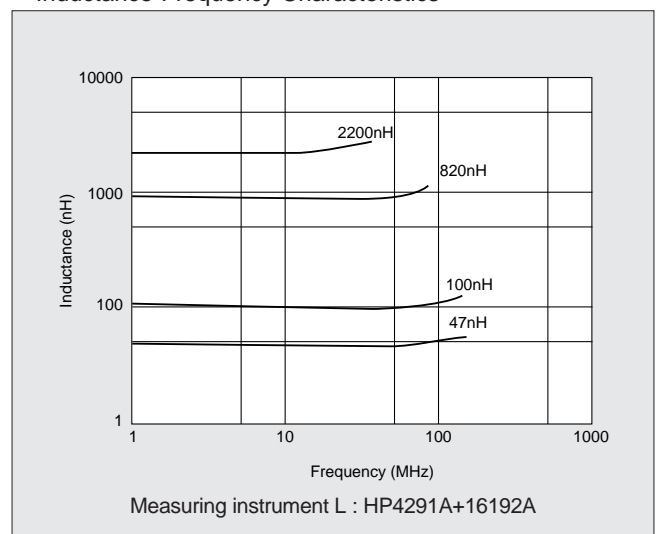

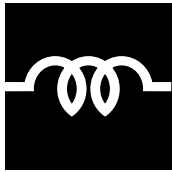

CHIP COIL



Multilayer Chip Coil **LQG21N** Series

Magnetically Shielded Multilayer Chip Coil Low Drift Excellent for High Density Mounting

The LQG21N series consists of magnetically shielded chip coils developed using original Murata multilayer process technology and magnetic materials. The coils occupy one quarter the volume of conventional chip coils and feature high reliability.

■FEATURES

1. Magnetically shielded structure provides excellent crosstalk characteristics.
2. Compact (2.0×1.25mm) and lightweight.
3. Low inductance drift resulting from soldering, environmental tests, etc.
4. Outstanding solder heat resistance. Either flow or reflow soldering can be used.

■APPLICATIONS

- Hard-disk drives
- Audio-Visual equipment
- Telecommunications equipment

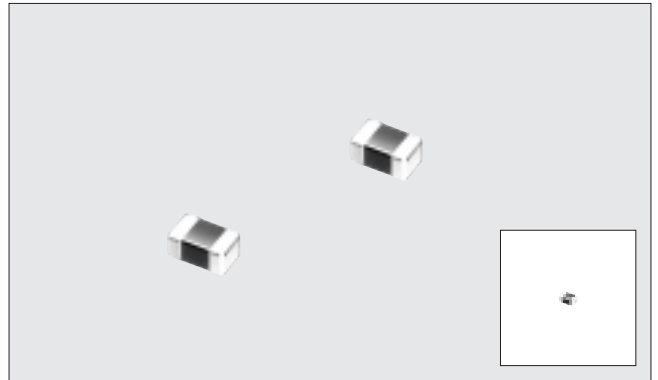

■DIMENSIONS

EIA Code:0805

(in mm)

Part Number	T
LQG21NR10K10-2R2K10	0.85±0.2
LQG21N2R7K10-4R7K10	1.25±0.2

■ SPECIFICATIONS

Part Number	Inductance			Q		DC Resistance (Ω max.)	Self-resonant Frequency (MHz min.)	Allowable Current (mA)	Operating Temp. Range
	Nominal Value(μH)	Tolerance (%)	Test Frequency	Nominal Value(min.)	Test Frequency				
LOG21NR10K10	0.10	±10	25MHz	20	25MHz	0.26	340	250	-40 to +85°C
LOG21NR12K10	0.12					0.29	310		
LOG21NR15K10	0.15					0.32	270		
LOG21NR18K10	0.18					0.35	250		
LOG21NR22K10	0.22					0.38	220		
LOG21NR27K10	0.27					0.42	200		
LOG21NR33K10	0.33					0.48	180		
LOG21NR39K10	0.39					0.53	165		
LOG21NR47K10	0.47					0.57	150		
LOG21NR56K10	0.56					0.63	140		
LOG21NR68K10	0.68		0.72	125					
LOG21NR82K10	0.82		0.81	115					
LOG21N1R0K10	1.0		10MHz	45	10MHz	0.40	107	50	
LOG21N1R2K10	1.2					0.47	97		
LOG21N1R5K10	1.5					0.50	87		
LOG21N1R8K10	1.8					0.57	80		
LOG21N2R2K10	2.2					0.63	71		
LOG21N2R7K10	2.7					0.69	66		
LOG21N3R3K10	3.3					0.80	59		
LOG21N3R9K10	3.9					0.89	53		
LOG21N4R7K10	4.7	1.00				47			

■ TYPICAL ELECTRICAL CHARACTERISTICS

● Q - Frequency Characteristics

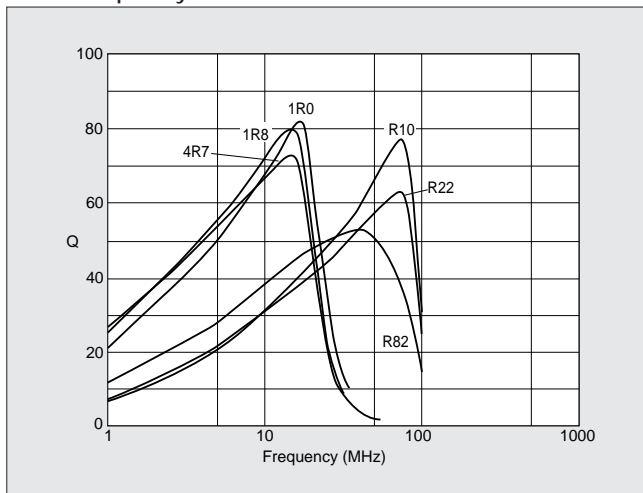

● Inductance - Temperature Characteristics

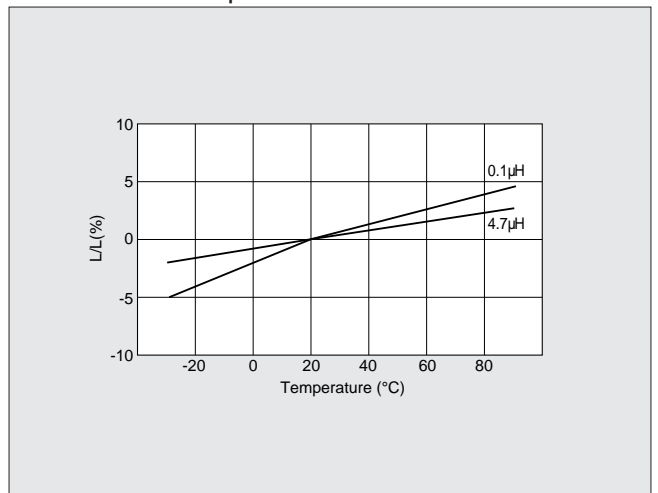

● Inductance - Current Characteristics

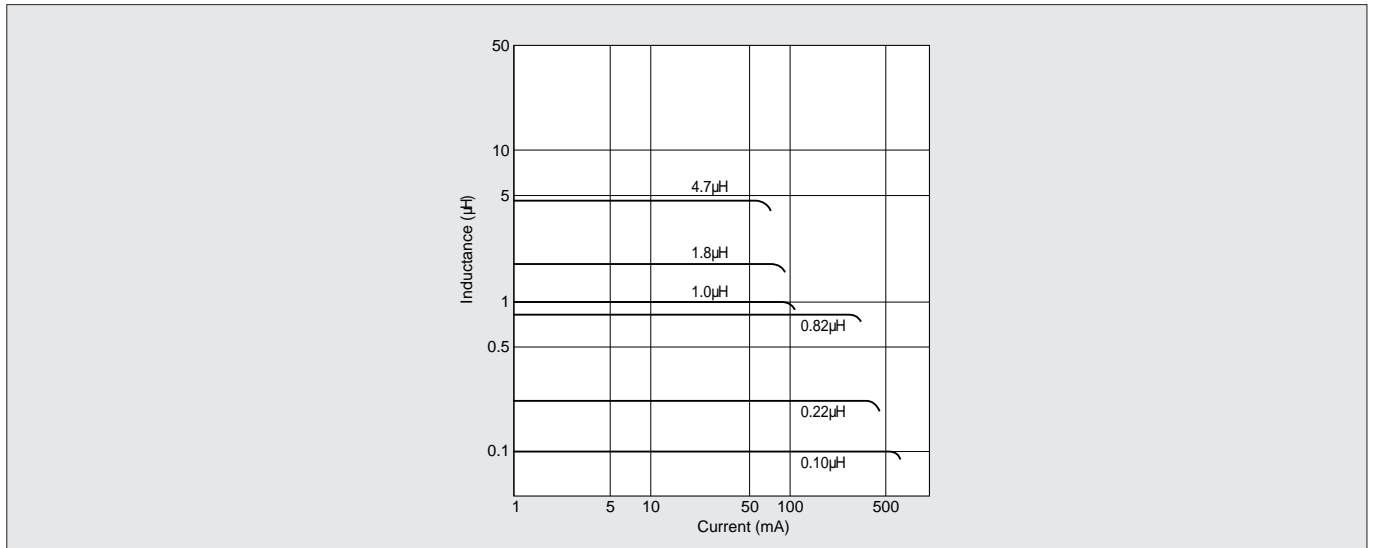

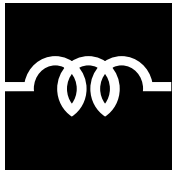

CHIP COIL



Small Tolerance Chip Coil **LQS33N** Series for Oscillation Circuits

High Q, Magnetically Shielded Chip Coil with Tight Inductance Tolerance ($\pm 2\%$), Perfect in Oscillation Circuits

The LQS33N series consists of closed, magnetically shielded chip inductors wound on ferrite bobbins developed by Murata.

Their high Q value virtually eliminates interference with nearby circuits. This, combined with their tight inductance tolerance, makes these chip inductors excellent in resonant circuits.

■FEATURES

1. The coil's outstanding stability yields a reduction in inductor tolerance to within $\pm 2\%$.
2. Its high Q (typically greater than 80) is present at all inductance values and is the basis of this chip coil's outstanding low loss circuit characteristics.
3. The ferrite core shielding structure both eliminates external interference and facilitates high mounting density.
4. Small inductance variation with respect to temperature change makes these coils applicable in traps or LC filters for stable frequency characteristics.
5. This series is thin and compact, with a thickness of merely 1.8mm.

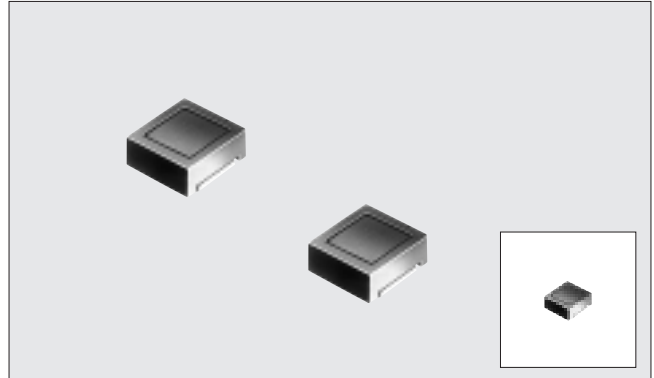

■DIMENSIONS

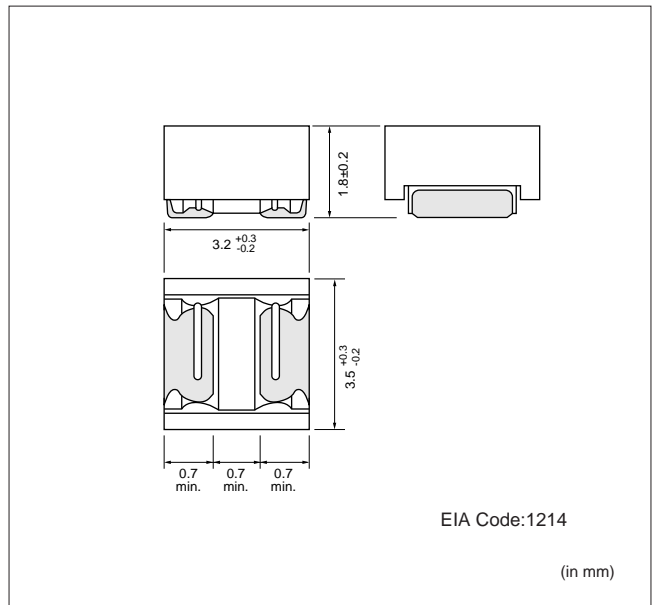

■ SPECIFICATIONS

Part Number	Inductance			Q		DC Resistance (Ω)	Self-resonant Frequency (MHz min.)	Allowable Current (mA)	Operating Temp. Range
	Nominal Value(μH)	Tolerance (%)	Test Frequency	Peak Value (Typ.)	Min. Value				
LQS33N1R0G(J)04	1.0	±2 (±5)	7.96 MHz	85	60	7.96 MHz	0.19±30%	120	-25 to +85°C
LQS33N1R2G(J)04	1.2						0.22±30%	100	
LQS33N1R5G(J)04	1.5						0.26±30%	80	
LQS33N1R8G(J)04	1.8						0.28±30%	70	
LQS33N2R2G(J)04	2.2						0.33±30%	60	
LQS33N2R7G(J)04	2.7			0.39±30%			55		
LQS33N3R3G(J)04	3.3			0.43±30%			50		
LQS33N3R9G(J)04	3.9			0.45±30%			45		
LQS33N4R7G(J)04	4.7			0.52±30%			40		
LQS33N5R6G(J)04	5.6			0.56±30%			37		
LQS33N6R8G(J)04	6.8		0.62±30%	35					
LQS33N8R2G(J)04	8.2		0.69±30%	32					
LQS33N100G(J)04	10		2.52 MHz	90	70	2.52 MHz	0.94±30%	30	
LQS33N120G(J)04	12						1.1 ±30%	27	
LQS33N150G(J)04	15						1.2 ±30%	25	
LQS33N180G(J)04	18						1.3 ±30%	23	
LQS33N220G(J)04	22						1.5 ±30%	20	
LQS33N270G(J)04	27			1.7 ±30%			18		
LQS33N330G(J)04	33			2.4 ±30%			16		
LQS33N390G(J)04	39			2.6 ±30%			15		
LQS33N470G(J)04	47	3.0 ±30%		14					
LQS33N560G(J)04	56	3.3 ±30%		13					
LQS33N680G(J)04	68	5.3 ±30%	12						
LQS33N820G(J)04	82	5.8 ±30%	11						
LQS33N101G(J)04	100	6.6 ±30%	10						

■ TYPICAL ELECTRICAL CHARACTERISTICS

● Q - Frequency Characteristics

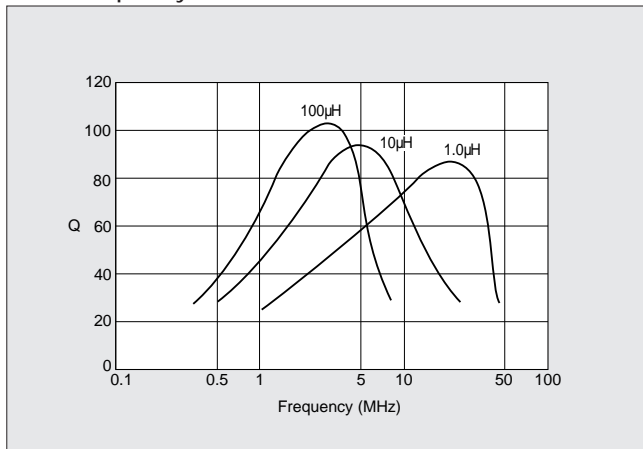

● Inductance - Temperature Characteristics

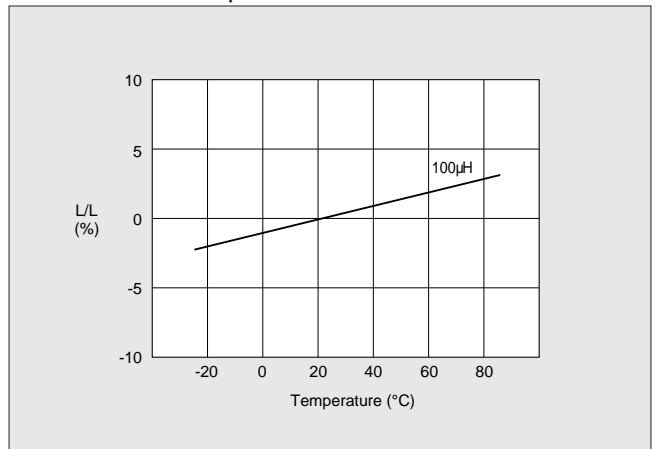

● Inductance - Current Characteristics

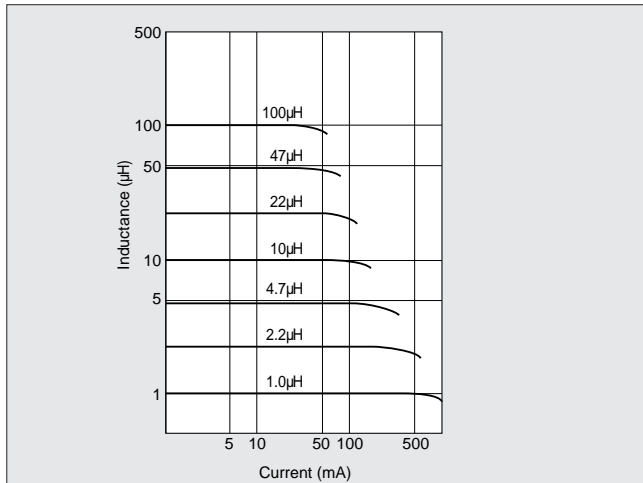

● Coupling Coefficient

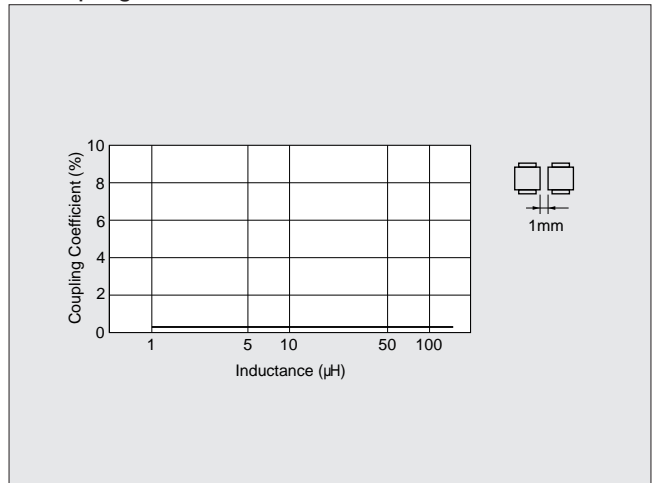

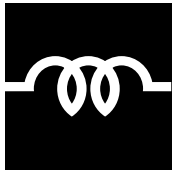

CHIP COIL



Multilayer Chip Inductor **LQG10A/11A** Series for High Frequency

High-Q, Stable Inductance in High Frequency Range Small Size Multilayer Chip Inductor for High Frequency Range

The LQG10A/11A series are chip inductors specifically designed for high frequency applications. The LQG10A/11A series is designed to realize stable characteristics in high frequency range applying integrated multilayer process. The integrated multilayer process enables a wide range of inductance values with tight tolerance.

■FEATURES

1. High-Q, stable inductance in high frequency is achieved by the unique low-capacitance structure. It is suitable for mobile communication equipment.
2. The small size of LQG10A (1.0X0.5X0.5mm) is ideal for small mobile equipment.
3. The external electrodes with nickel barrier structure provide excellent solder heat resistance.

■APPLICATIONS

- High frequency circuit of telecommunication equipment such as CDMA, DECT, PHS, PCS, PCN, GSM and DCS.

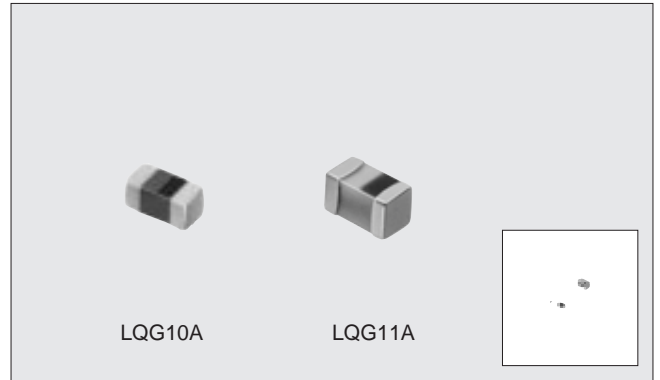

■DIMENSIONS

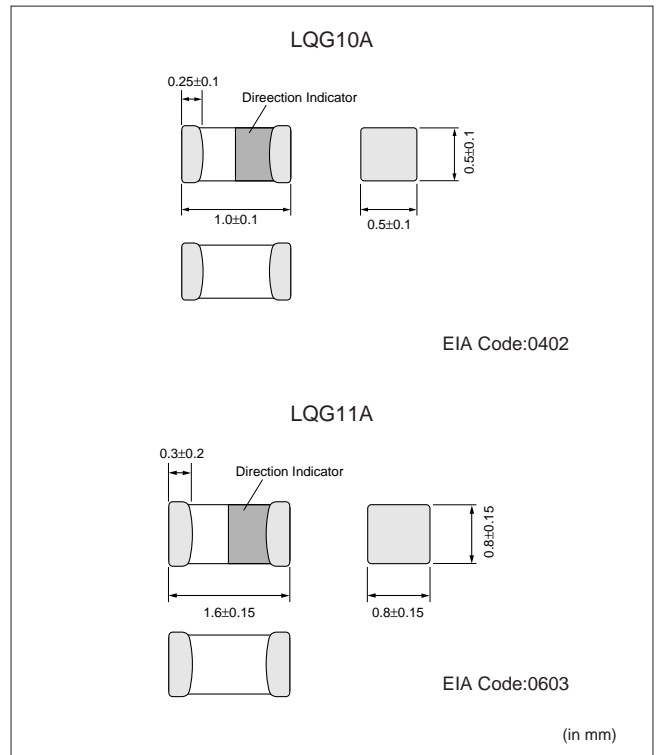

■SPECIFICATIONS

LQG10A

Part Number	Inductance			Q			DC Resistance (Ω max.)	Self-resonant Frequency (MHz min)	Allowable Current (mA)	Operating Temp. Range								
	Nominal Value (nH)	Tolerance	Test Frequency (MHz)	Nominal Value (min.)	Test Frequency (MHz)	500MHz (typ.)					800MHz (typ.)	1GHz (typ.)						
LQG10A1N2S00	1.2	±0.3nH	100	8	100	25	35	38	0.10	6000	200	-40 to +85°C						
LQG10A1N5S00	1.5						33											
LQG10A1N8S00	1.8					24	31	34										
LQG10A2N2S00	2.2						22	30					33					
LQG10A2N7S00	2.7					29		32					0.17					
LQG10A3N3S00	3.3												0.19					
LQG10A3N9S00	3.9					23	29	32					0.19	5300				
LQG10A4N7S00	4.7												0.23					
LQG10A5N6S00	5.6					±5%	100	8					100	23	29	32	0.26	4200
LQG10A6N8J00	6.8														29		0.29	
LQG10A8N2J00	8.2	24	31	34	0.33				3600									
LQG10A10NJ00	10		30		0.35													
LQG10A12NJ00	12	30	31	33	0.41				2800									
LQG10A15NJ00	15				0.46													
LQG10A18NJ00	18	29	32	31	0.51				2100									
LQG10A22NJ00	22				0.58													
LQG10A27NJ00	27	23	27	27	0.67				1600									
LQG10A33NJ00	33									22	23	24		1500				

LQG11A

Part Number	Inductance			Q		DC Resistance (Ω max.)	Self-resonant Frequency (MHz min.)	Allowable Current (mA)	Operating Temp. Range
	Nominal Value (nH)	Tolerance	Test Frequency (MHz)	Nominal Value (min.)	Test Frequency (MHz)				
LQG11A1N2S00	1.2	±0.3nH	100	12	100	0.10	6000	300	-40 to +85°C
LQG11A1N5S00	1.5								
LQG11A1N8S00	1.8								
LQG11A2N2S00	2.2					0.15			
LQG11A2N7S00	2.7								
LQG11A3N3S00	3.3								
LQG11A3N9S00	3.9					0.20	5000		
LQG11A4N7S00	4.7								
LQG11A5N6S00	5.6					0.25	4000		
LQG11A6N8J(K)00	6.8								
LQG11A8N2J(K)00	8.2	±5% (±10%)	100	12	100	0.30	3500		
LQG11A10NJ(K)00	10					0.35	3000		
LQG11A12NJ(K)00	12					0.40	2800		
LQG11A15NJ(K)00	15					0.45	2600		
LQG11A18NJ(K)00	18					0.50	2300		
LQG11A22NJ(K)00	22					0.55	2000		
LQG11A27NJ(K)00	27					0.60	1700		
LQG11A33NJ(K)00	33					0.65	1500		
LQG11A39NJ(K)00	39					0.70	1200		
LQG11A47NJ(K)00	47					0.75	1100		
LQG11A56NJ(K)00	56	0.80	1000						
LQG11A68NJ(K)00	68	0.85	900						
LQG11A82NJ(K)00	82	0.90	800						
LQG11AR10J(K)00	100								

■ TYPICAL ELECTRICAL CHARACTERISTICS

● Q-Frequency Characteristics

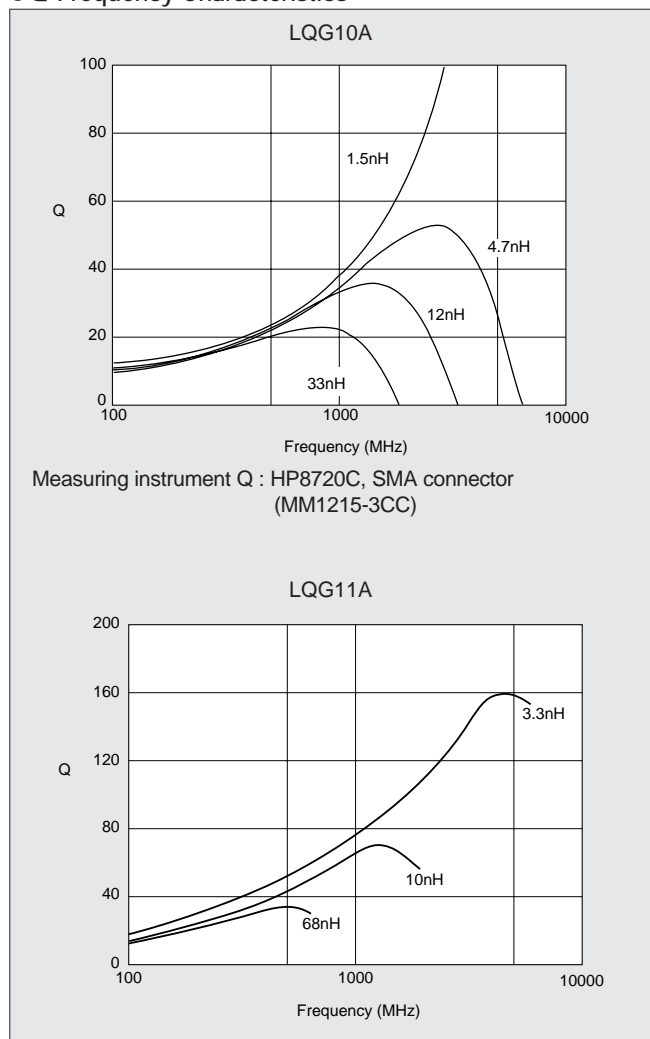

● Inductance - Frequency Characteristics

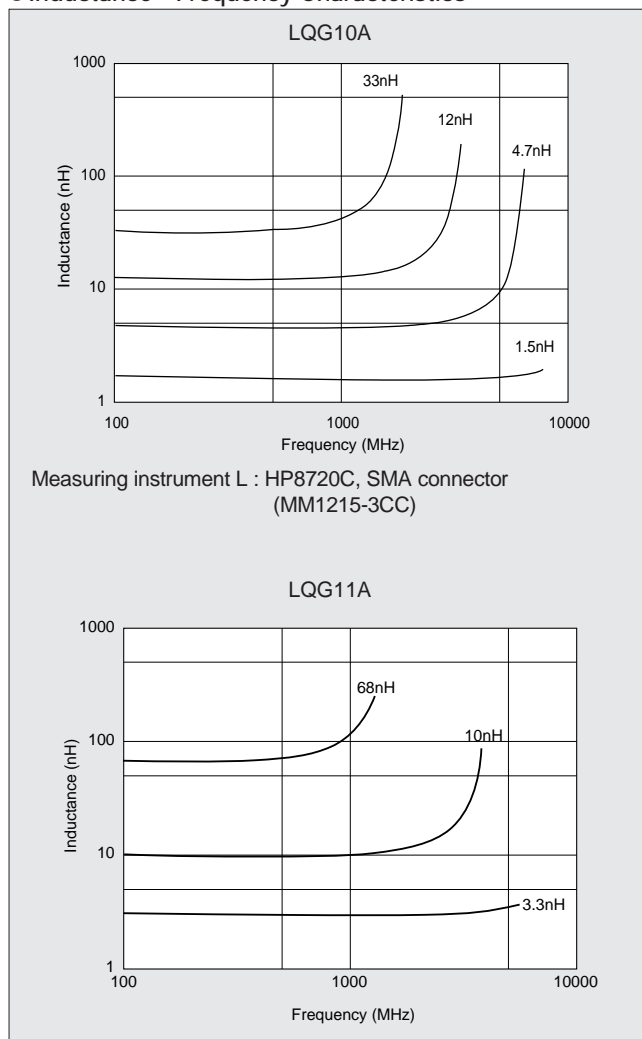

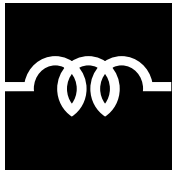

CHIP COIL



Thin Film Chip Coil **LQP10A/LQP11A** Series for High Frequency

Tight Inductance Tolerance Chip Coil for High Frequency Application Small Size and Tight Inductance Tolerance ($\pm 0.2\text{nH}$ or $\pm 2\%$)

The LQP10A/LQP11A series consists of chip coils with a tight inductance tolerance ($\pm 0.2\text{nH}$ or $\pm 2\%$) achieved even in low inductance region.

FEATURES

1. Tight inductance tolerance ($\pm 0.2\text{nH}$, $\pm 2\%$) realized by thin-film technology enables assemble with no tuning.
2. High self resonant frequency due to low stray capacitance and close inductance distribution provide stable inductance in high frequency circuit such as telecommunication equipment.
3. The external electrodes with nickel barrier structure provide excellent solder heat resistance.

● LQP10A

Ultra-Small size 0402 inductor which is low, and lightest weight (half of multilayer type) in the world enables to miniaturize mobile telephone.

● LQP11A

Small size of 0603 (LQP11A) is suitable for small hand held equipment, especially for card size equipment.

APPLICATIONS

- High frequency circuit of telecommunication equipment, such as DECT, PHS, PCS, PCN, GSM, DCS and CDMA.
- Impedance Matching—Power-AMP Module (PA), SAW filter
- Resonance circuits—VCO

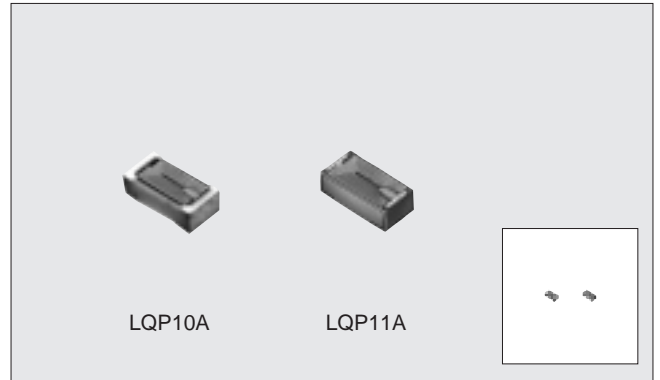

The appearance of coil pattern depends on the part number.

DIMENSIONS

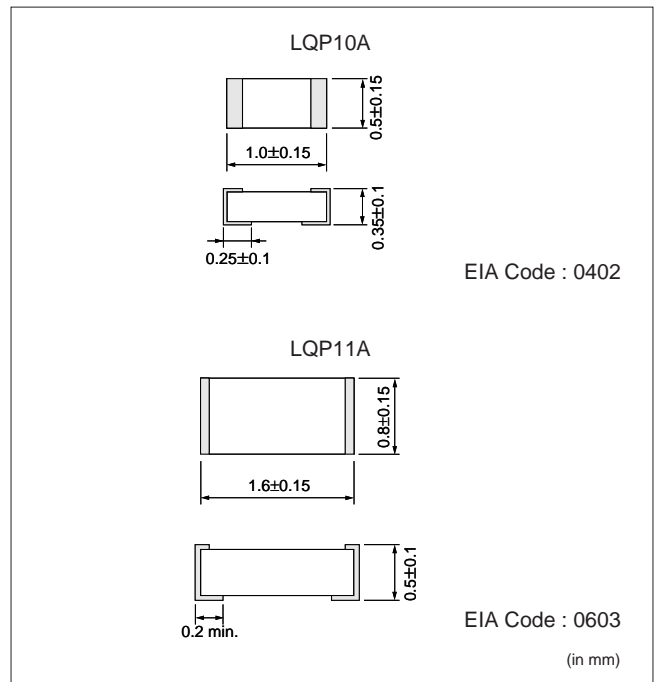

Use plastic tweezers when treating with tweezers.

■SPECIFICATIONS

LQG10A

Part Number	Inductance			Q			DC Resistance (Ω max.)	Self-resonant Frequency (MHz min)	Allowable Current (mA)	Operating Temp. Range
	Nominal Value (nH)	Tolerance	Test Frequency (MHz)	Typical @1GHz	Min. Value	Test Frequency (MHz)				
LQP10A1N0B(C)00	1.0	±0.1nH (±0.2nH)	500	50	13	500	0.1	6000	400	-40 to +85°C
LQP10A1N1B(C)00	1.1								390	
LQP10A1N2B(C)00	1.2								280	
LQP10A1N3B(C)00	1.3									
LQP10A1N5B(C)00	1.5									
LQP10A1N6B(C)00	1.6			220						
LQP10A1N8B(C)00	1.8			280						
LQP10A2N0B(C)00	2.0			40			220			
LQP10A2N2B(C)00	2.2									
LQP10A2N4B(C)00	2.4			35						
LQP10A2N7B(C)00	2.7									
LQP10A3N0B(C)00	3.0			30			190			
LQP10A3N3B(C)00	3.3									
LQP10A3N6B(C)00	3.6			28			170			
LQP10A3N9B(C)00	3.9									
LQP10A4N3B(C)00	4.3			29			160			
LQP10A4N7B(C)00	4.7									
LQP10A5N1B(C)00	5.1			26			140			
LQP10A5N6B(C)00	5.6									
LQP10A6N2B(C)00	6.2									
LQP10A6N8B(C)00	6.8									
LQP10A7N5B(C)00	7.5									
LQP10A8N2B(C)00	8.2	25	110							
LQP10A9N1B(C)00	9.1									
LQP10A10NG(J)00	10	±2% (±5%)	25	90						
LQP10A12NG(J)00	12									
LQP10A15NG(J)00	15			80						
LQP10A18NG(J)00	18									
LQP10A22NG(J)00	22			70						
LQP10A27NG(J)00	27									
LQP10A33NG(J)00	33			60						

LQG11A

Part Number	Inductance			Q			DC Resistance (Ω max.)	Self-resonant Frequency (MHz min)	Allowable Current (mA)	Operating Temp. Range	
	Nominal Value (nH)	Tolerance	Test Frequency (MHz)	Peak Value (Typ.)	Min. Value	Test Frequency (MHz)					
LQP11A1N3C00	1.3	$\pm 0.2\text{nH}$	500	160	17	500	0.3	6000	300	-40 to +85°C	
LQP11A1N5C00	1.5			140			0.4				
LQP11A1N8C00	1.8			120							
LQP11A2N2C00	2.2			100							
LQP11A2N7C00	2.7			90			0.5		5900		200
LQP11A3N3C00	3.3			85							
LQP11A3N9C00	3.9			80							
LQP11A4N7C00	4.7			75			0.6	4700	200		
LQP11A5N6C00	5.6			65							
LQP11A6N8C00	6.8			63							
LQP11A8N2C00	8.2			57			0.7	4300	200		
LQP11A10NG00	10			55							
LQP11A12NG00	12			50							0.8
LQP11A15NG00	15			43							
LQP11A18NG00	18	39									
LQP11A22NG00	22	38	1.0	3400	150						
LQP11A27NG00	27	32									
LQP11A33NG00	33	30				1.3	2700	100			
LQP11A39NG00	39	28									
LQP11A47NG00	47	26									
LQP11A56NG00	56	28	1.5	2300	100						
LQP11A68NG00	68	27									
LQP11A82NG00	82	25				1.9	2100	100			
LQP11AR10G00	100	25									
			2.4	1900	100						
						2.8	1700	100			
			3.4	1000	50						
						3.5	900	50			
			4.6	800	50						
						6.1	700	50			

■ TYPICAL ELECTRICAL CHARACTERISTICS

● Q-Frequency Characteristics

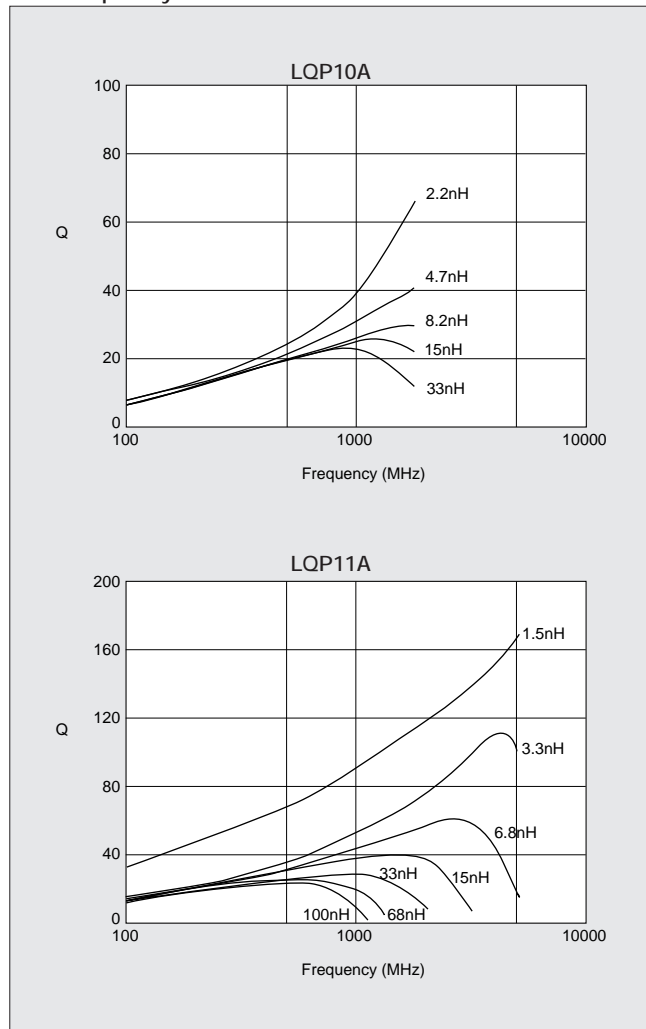

● Inductance - Frequency Characteristics

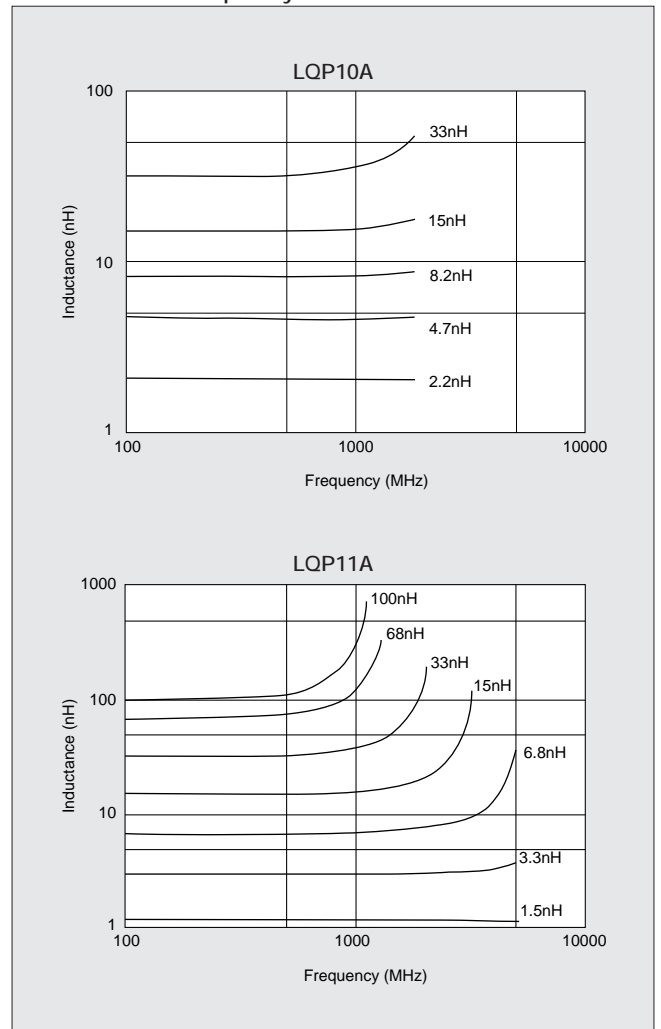

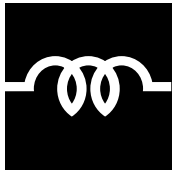

CHIP COIL



Wire Wound Chip Coil **LQW1608A** Series for High Frequency

High-Q and Tight Inductance Tolerance ($\pm 0.2\text{nH}$ or $\pm 2\%$) Ultra Small Wire Wound Air-core Chip Coil

The LQW1608A series which consists of air-core chip coil using a miniature alumina core.

The tight inductance tolerance ($\pm 0.2\text{nH}$, $\pm 2\%$) is available due to Murata's original winding technology. The series has high Q value and high self resonant frequency in high frequency range. It is suitable for high frequency circuits which are used in telecommunication equipment.

■FEATURES

1. Horizontal winding structure enables tight inductance tolerance ($\pm 0.2\text{nH}$, $\pm 2\%$). Stable circuit operation is possible.
2. Broad range of inductance (3.9nH to 220nH).
3. The subminiature dimensions (1.6X0.8mm) allow high density mounting.
4. The high self resonant frequency realizes high-Q value and stable inductance at high frequency.
5. Low DC resistance design is ideal for low loss, high output and low power consumption.
4. Resin-coated surface enables excellent mounting.

■APPLICATIONS

- High frequency circuit in telecommunication equipment, such as DECT, PHS, PCS, PCN, GSM and CDMA.
- Impedance Matching—Power-AMP Module (PA), SAW filter
- Resonance circuits—VCO

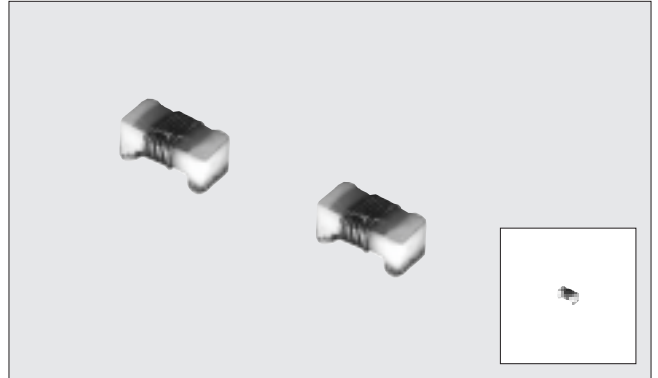

■DIMENSIONS

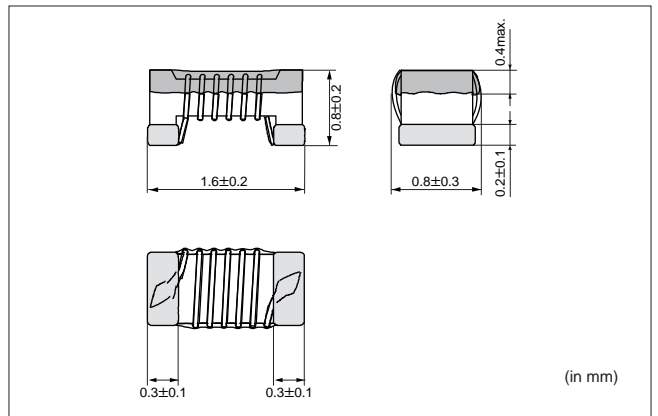

■SPECIFICATIONS

Part Number	Inductance			Q					DC Resistance (Ω max.)	Self-resonant Frequency (MHz min.)	Allowable Current (mA)	Operating Temp. Range															
	Nominal Value (nH)	Tolerance	Test Frequency (MHz)	Nominal Value (min.)	Test Frequency (MHz)	300 (MHz) Typical	800 (MHz) Typical	1.5 (GHz) Typical																			
LQW1608A2N2D00	2.2	±0.5nH	100	16	250	45	80	110	0.049	6000	700	-25 to +85°C															
LQW1608A3N6D(C)00	3.6	±0.5nH (±0.2nH)		25																							
LQW1608A3N9D(C)00	3.9																										
LQW1608A4N3D(C)00	4.3																										
LQW1608A4N7D00	4.7	±0.5nH		35									250	45	75	95	0.059	6000	850								
LQW1608A5N6D(C)00	5.6	±0.5nH (±0.2nH)																									
LQW1608A6N2D(C)00	6.2																										
LQW1608A6N8D(C)00	6.8																										
LQW1608A7N5D00	7.5	±0.5nH																		35	250	45	80	100	0.082	6000	750
LQW1608A8N2D00	8.2																										
LQW1608A8N7D00	8.7																										
LQW1608A9N1D00	9.1																										
LQW1608A9N5D00	9.5																										
LQW1608A10NJ(G)00	10																										
LQW1608A11NJ(G)00	11																										
LQW1608A12NJ(G)00	12																										
LQW1608A13NJ(G)00	13																										
LQW1608A15NJ(G)00	15																										
LQW1608A16NJ(G)00	16																										
LQW1608A18NJ(G)00	18																										
LQW1608A20NJ(G)00	20																										
LQW1608A22NJ(G)00	22																										
LQW1608A24NJ(G)00	24																										
LQW1608A27NJ(G)00	27																										
LQW1608A30NJ(G)00	30																										
LQW1608A33NJ(G)00	33																										
LQW1608A36NJ(G)00	36																										
LQW1608A39NJ(G)00	39																										
LQW1608A43NJ(G)00	43																										
LQW1608A47NJ(G)00	47																										
LQW1608A51NJ(G)00	51																										
LQW1608A56NJ(G)00	56																										
LQW1608A62NJ(G)00	62																										
LQW1608A68NJ(G)00	68																										
LQW1608A72NJ(G)00	72																										
LQW1608A75NJ(G)00	75																										
LQW1608A82NJ(G)00	82																										
LQW1608A91NJ(G)00	91																										
LQW1608AR10J(G)00	100	150	32	100	45	75	50	0.13	6000	600																	
LQW1608AR11J(G)00	110																										
LQW1608AR12J(G)00	120																										
LQW1608AR13J(G)00	130																										
LQW1608AR15J(G)00	150																										
LQW1608AR16J(G)00	160																										
LQW1608AR18J(G)00	180																										
LQW1608AR20J(G)00	200																										
LQW1608AR22J(G)00	220																										
LQW1608A43NJ(G)00	43										150	34	100	45	80	60	0.16	6000	550								
LQW1608A47NJ(G)00	47																										
LQW1608A51NJ(G)00	51																										
LQW1608A56NJ(G)00	56																										
LQW1608A62NJ(G)00	62																										
LQW1608A68NJ(G)00	68																										
LQW1608A72NJ(G)00	72																										
LQW1608A75NJ(G)00	75																										
LQW1608A82NJ(G)00	82																										
LQW1608A91NJ(G)00	91																										
LQW1608AR10J(G)00	100	150	32	100	45	75	50	0.17	6000	500																	
LQW1608AR11J(G)00	110																										
LQW1608AR12J(G)00	120																										
LQW1608AR13J(G)00	130																										
LQW1608AR15J(G)00	150																										
LQW1608AR16J(G)00	160																										
LQW1608AR18J(G)00	180																										
LQW1608AR20J(G)00	200																										
LQW1608AR22J(G)00	220																										
LQW1608A43NJ(G)00	43										150	34	100	45	80	60	0.21	6000	440								
LQW1608A47NJ(G)00	47																										
LQW1608A51NJ(G)00	51																										
LQW1608A56NJ(G)00	56																										
LQW1608A62NJ(G)00	62																										
LQW1608A68NJ(G)00	68																										
LQW1608A72NJ(G)00	72																										
LQW1608A75NJ(G)00	75																										
LQW1608A82NJ(G)00	82																										
LQW1608A91NJ(G)00	91																										
LQW1608AR10J(G)00	100	150	32	100	45	75	50	0.23	6000	420																	
LQW1608AR11J(G)00	110																										
LQW1608AR12J(G)00	120																										
LQW1608AR13J(G)00	130																										
LQW1608AR15J(G)00	150																										
LQW1608AR16J(G)00	160																										
LQW1608AR18J(G)00	180																										
LQW1608AR20J(G)00	200																										
LQW1608AR22J(G)00	220																										
LQW1608A43NJ(G)00	43										150	34	100	45	80	60	0.26	6000	400								
LQW1608A47NJ(G)00	47																										
LQW1608A51NJ(G)00	51																										
LQW1608A56NJ(G)00	56																										
LQW1608A62NJ(G)00	62																										
LQW1608A68NJ(G)00	68																										
LQW1608A72NJ(G)00	72																										
LQW1608A75NJ(G)00	75																										
LQW1608A82NJ(G)00	82																										
LQW1608A91NJ(G)00	91																										
LQW1608AR10J(G)00	100	150	32	100	45	75	50	0.29	6000	380																	
LQW1608AR11J(G)00	110																										
LQW1608AR12J(G)00	120																										
LQW1608AR13J(G)00	130																										
LQW1608AR15J(G)00	150																										
LQW1608AR16J(G)00	160																										
LQW1608AR18J(G)00	180																										
LQW1608AR20J(G)00	200																										
LQW1608AR22J(G)00	220																										
LQW1608A43NJ(G)00	43										150	34	100	45	80	60	0.33	6000	370								
LQW1608A47NJ(G)00	47																										
LQW1608A51NJ(G)00	51																										
LQW1608A56NJ(G)00	56																										
LQW1608A62NJ(G)00	62																										
LQW1608A68NJ(G)00	68																										
LQW1608A72NJ(G)00	72																										
LQW1608A75NJ(G)00	75																										
LQW1608A82NJ(G)00	82																										
LQW1608A91NJ(G)00	91																										
LQW1608AR10J(G)00	100	150	32	100	45	75	50	0.35	6000	360																	
LQW1608AR11J(G)00	110																										
LQW1608AR12J(G)00	120																										
LQW1608AR13J(G)00	130																										
LQW1608AR15J(G)00	150																										
LQW1608AR16J(G)00	160																										
LQW1608AR18J(G)00	180																										
LQW1608AR20J(G)00	200																										
LQW1608AR22J(G)00	220																										
LQW1608A43NJ(G)00	43										150	34	100	45	80	60	0.51	6000	280								
LQW1608A47NJ(G)00	47																										
LQW1608A51NJ(G)00	51																										
LQW1608A56NJ(G)00	56																										
LQW1608A62NJ(G)00	62																										
LQW1608A68NJ(G)00	68																										
LQW1608A72NJ(G)00	72																										
LQW1608A75NJ(G)00	75																										
LQW1608A82NJ(G)00	82																										
LQW1608A91NJ(G)00	91																										
LQW1608AR10J(G)00	100	150	32	100	45	75	50	0.38	6000	340																	
LQW1608AR11J(G)00	110																										
LQW1608AR12J(G)00	120																										
LQW1608AR13J(G)00	130																										
LQW1608AR15J(G)00	150																										
LQW1608AR16J(G)00	160																										
LQW1608AR18J(G)00	180																										
LQW1608AR20J(G)00	200																										
LQW1608AR22J(G)00	220																										
LQW1608A43NJ(G)00	43										150	34	100	45	80	60	0.60	6000	270								
LQW1608A47NJ(G)00	47																										
LQW1608A51NJ(G)00	51																										
LQW1608A56NJ(G)00	56																										
LQW1608A62NJ(G)00	62																										
LQW1608A68NJ(G)00	68																										
LQW1608A72NJ(G)00	72																										
LQW1608A75NJ(G)00	75																										
LQW1608A82NJ(G)00	82																										
LQW1608A91NJ(G)00	91																										
LQW1608AR10J(G)00	100	150	32	100	45	75	50	0.64	6000	230																	
LQW1608AR11J(G)00	110																										
LQW1608AR12J(G)00	120																										
LQW1608AR13J(G)00	130																										
LQW1608AR15J(G)00	150																										
LQW1608AR16J(G)00	160																										
LQW1608AR18J(G)00	180																										
LQW1608AR20J(G)00	200																										
LQW1608AR22J(G)00	220																										
LQW1608A43NJ(G)00	43										150	34	100	45	80	60	0.68	6000	220								
LQW1608A47NJ(G)00	47																										
LQW1608A51NJ(G)00	51																										
LQW1608A56NJ(G)00	56																										
LQW1608A62NJ(G)00	62																										
LQW1608A68NJ(G)00	68																										
LQW1608A72NJ(G)00	72																										
LQW1608A75NJ(G)00	75																										
LQW1608A82NJ(G)00	82																										
LQW1608A91NJ(G)00	91																										
LQW1608AR10J(G)00	100	150	32	100	45	75	50	1.2	6000	200																	
LQW1608AR11J(G)00	110																										
LQW1608AR12J(G)00	120																										
LQW1608AR13J(G)00	130																										
LQW1608AR15J(G)00	150																										
LQW1608AR16J(G)00	160																										
LQW1608AR18J(G)00	180																										
LQW1608AR20J(G)00	200																										
LQW1608AR22J(G)00	220																										
LQW1608A43NJ(G)00	43										150	34	100	45	80	60	2.1	6000	150								
LQW1608A47NJ(G)00	47																										
LQW1608A51NJ(G)00	51																										
LQW1608A56NJ(G)00	56																										
LQW1608A62NJ(G)00	62																										
LQW1608A68NJ(G)00	68																										
LQW1608A72NJ(G)00	72																										
LQW1608A75NJ(G)00	75																										
LQW1608A82NJ(G)00	82																										
LQW1608A91NJ(G)00	91																										
LQW1608AR10J(G)00	100	150	32	100	45	75	50	2.2	6000	140																	
LQW1608AR11J(G)00	110																										
LQW1608AR12J(G)00	120																										
LQW1608AR13J(G)00	130																										
LQW1608AR15J(G)00	150																										
LQW1608AR16J(G)00	160																										
LQW1608AR18J(G)00	180																										
LQW1608AR20J(G)00	200																										
LQW1608AR22J(G)00	220																										
LQW1608A43NJ(G)00	43										150	34	100	45	80	60	2.4	6000	120								
LQW1608A47NJ(G)00	47																										
LQW1608A51NJ(G)00	51																										
LQW1608A56NJ(G)00	56																										
LQW1608A62NJ(G)00	62																										
LQW1608A68NJ(G)00	68																										
LQW1608A72NJ(G)00	72																										
LQW1608A75NJ(G)00	75																										
LQW1608A82NJ(G)00	82																										
LQW1608A91NJ(G)00	91																										
LQW1608AR10J(G)00	100	150	32	100	45	75	50	2.5	6000	120																	
LQW1608AR11J(G)00	110																										
LQW1608AR12J(G)00	120																										
LQW1608AR13J(G)00	130																										
LQW1608AR15J(G)00	150																										
LQW1608AR16J(G)00	160																										
LQW1608AR18J(G)00	180																										
LQW1608AR20J(G)00	200																										
LQW1608AR22J(G)00	220																										

■ TYPICAL ELECTRICAL CHARACTERISTICS

● Q-Frequency Characteristics

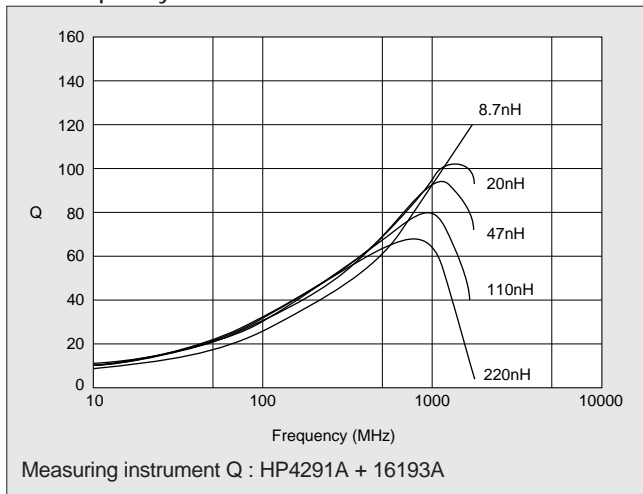

● Inductance - Frequency Characteristics

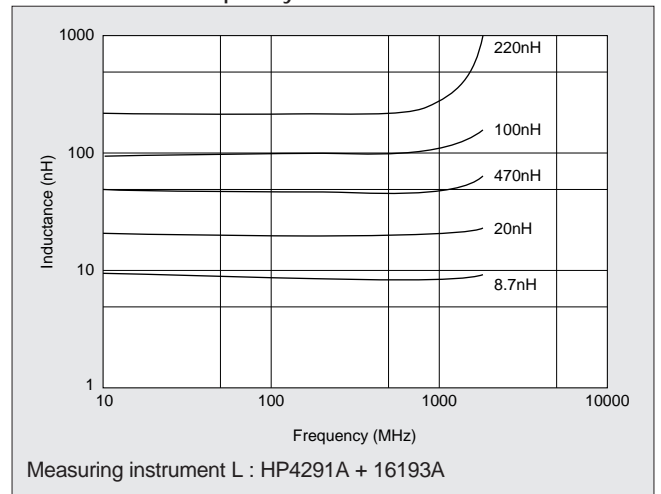

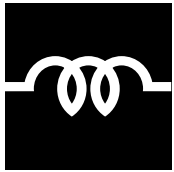

CHIP COIL



Wire Wound Chip Coil LQN21A/LQN1A Series for High Frequency

Small Winding-type Air-core Chip Coil with High Q value at High Frequencies and Low DC Resistance

The LQN21A/LQN1A series consists of air-core chip coil using a sub-miniature alumina core as a bobbin. The high Q value at high frequencies and high self-resonant frequencies make this coil perfect for use in the high frequency circuits of communications equipment.

FEATURES

1. LQN21A series covers inductance range from 3.3nH to 470nH.
2. Their high self-resonant frequency characteristic yields a high Q value and highly stable inductance at high frequencies.
3. Low DC resistance design enables to handle higher allowable current.
4. The series has excellent solder heat resistance. Both flow and reflow soldering methods can be employed.

- LQN21Axxxx04
Inductance tolerance $\pm 0.5\text{nH}$ (8.2nH max.), $\pm 5\%$ (10nH to 220nH) and $\pm 10\%$ (270nH to 470nH) are realized. The sub miniature dimensions (2.0×1.5mm) allow high density mounting.
- LQN21A (Tight inductance tolerance)
Tight inductance tolerance of $\pm 2\%$ is available.
- LQN21Axxxx44
LQN21Axxxx44 using thick wire ($\phi 0.12\text{mm}$) has higher Q value than existing LQN21A series. Low DC resistance design enables to handle higher current. LQN21Axxxx44 covers inductance range from 2.7nH to 27nH.
- LQN1A
Miniature size (3.2×1.6×1.8mm) allows parallel mounting at 2.5mm pitch. Inductance tolerance $\pm 5\%$ realized.

APPLICATIONS

- High frequency circuit in telecommunication equipment, such as DECT, PHS, PCS, PCN, GSM and CDMA.
- Impedance Matching—Power-AMP Module (PA), SAW filter
- Resonance circuits—VCO

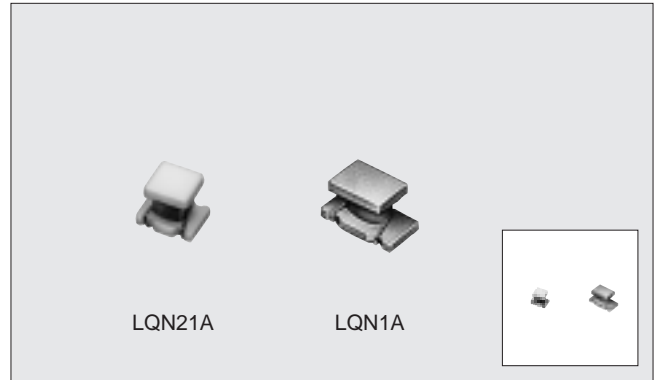

DIMENSIONS

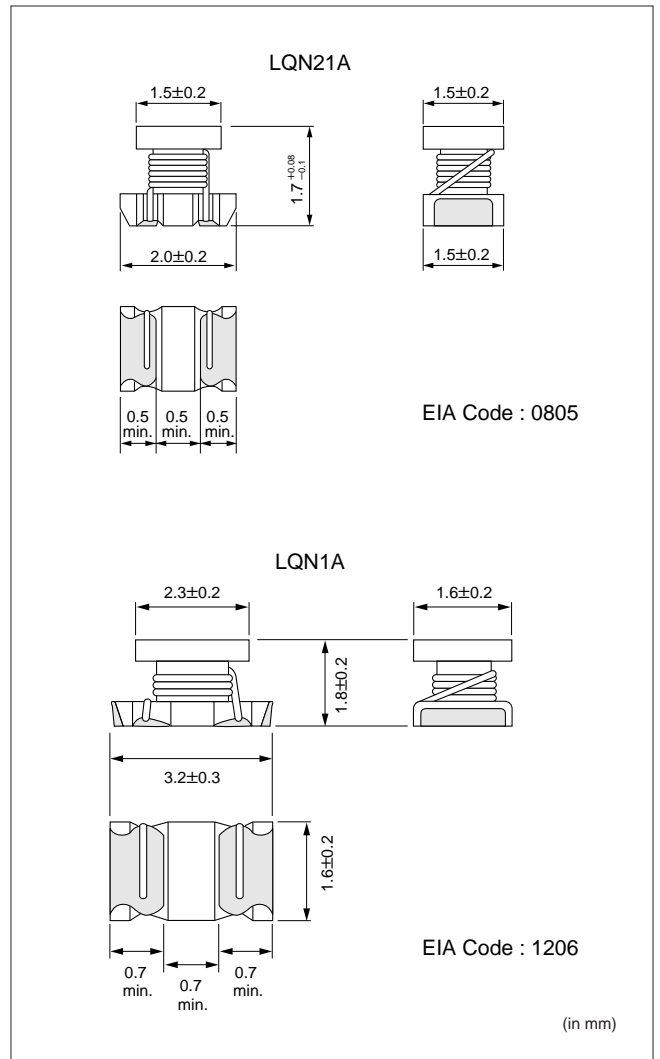

■SPECIFICATIONS

LQN21Axxxx04

Part Number	Inductance			Q *1			DC Resistance (Ω max.)	Self-resonant Frequency (MHz min.)	Allowable Current (mA)	Operating Temp. Range
	Nominal Value (nH)	Tolerance	Test Frequency (MHz)	Peak Value (Typ.)	Min. Value	Test Frequency (MHz)				
LQN21A3N3D04	3.3	±0.5nH	100	70	10	250	0.05	6000	910	-25 to +85°C
LQN21A6N8D(K)04	6.8	±0.5nH			20		0.11	5400	680	
LQN21A8N2D(K)04	8.2	(±10%)			80		0.12	3900	630	
LQN21A10NJ(K)04	10	±5% (±10%)			65		0.03	3300	1320	
LQN21A12NJ(K)04	12				70		0.11	3200	680	
LQN21A15NJ(K)04	15				30		0.12	2700	630	
LQN21A18NJ(K)04	18				70		0.10	2600	690	
LQN21A22NJ(K)04	22				40		0.09	2100	720	
LQN21A27NJ(K)04	27				70		0.17	2300	540	
LQN21A33NJ(K)04	33				65		0.15	1900	570	
LQN21A39NJ(K)04	39				80		0.09	1700	730	
LQN21A47NJ(K)04	47				65		0.23	1600	450	
LQN21A56NJ(K)04	56				70		0.26	1500	430	
LQN21A68NJ(K)04	68	65			0.23		1200	460		
LQN21A82NJ(K)04	82	60			0.42		1100	320		
LQN21AR10J(K)04	100	70			0.38		900	350		
LQN21AR12J(K)04	120	50			0.40		750	320		
LQN21AR15J(K)04	150	45			0.47		350	390		
LQN21AR18J(K)04	180	35			0.71		700	250		
LQN21AR22J(K)04	220	35			0.70		500	240		
LQN21AR27K04	270	±10%	10	50	15	25.2	2.00	550	190	
LQN21AR33K04	330						2.20	500	180	
LQN21AR39K04	390						2.50	400	170	
LQN21AR47K04	470						2.80	350	160	

LQN21A (Tight inductance tolerance)

Part Number	Inductance			Q *1			DC Resistance (Ω max.)	Self-resonant Frequency (MHz min.)	Allowable Current (mA)	Operating Temp. Range
	Nominal Value (nH)	Tolerance	Test Frequency (MHz)	Peak Value (Typ.)	Min. Value	Test Frequency (MHz)				
LQN21A33NG04	33	±2%	100	65	40	250	0.15	1900	570	-25 to +85°C
LQN21A39NG04	39			80			0.09	1700	730	
LQN21A47NG04	47			65			0.23	1600	450	
LQN21A56NG04	56			70			0.26	1500	430	
LQN21A68NG04	68			65			0.23	1200	460	
LQN21A82NG04	82			60			0.42	1100	320	
LQN21AR10G04	100			55			0.55	900	270	
LQN21AR12G04	120			50			0.40	750	320	
LQN21AR15G04	150			55			0.68	350	260	
LQN21AR18G04	180			50			0.71	700	250	
LQN21AR22G04	220			35			0.70	500	240	

*1 Measured with LCR meter YHP4191A, measuring tap 16193A.

*2 Measured with Network Analyzer HP8753C.

LQN21Axxxx44

Part Number	Inductance			Q				DC Resistance (Ω max.)	Self-resonant Frequency (MHz min.)	Allowable Current (mA)	Operating Temp. Range		
	Nominal Value (nH)	Tolerance	Test Frequency (MHz)	Nominal Value (min.)	Test Frequency (MHz)	800MHz (Typ.)	1.5GHz (Typ.)						
LQN21A2N7D44	2.7	±0.5nH	100	20	250	85	120	0.02	6000	1900	-25 to +85°C		
LQN21A3N1D44	3.1						1800						
LQN21A3N3D44	3.3						1700						
LQN21A5N6D44	5.6						1500						
LQN21A6N8D44	6.8						5400			1400			
LQN21A8N6D44	8.6									1300			
LQN21A10NJ44	10	±5%	40	250	105	90	0.03	3900	3300				
LQN21A12NK44	12	±10%							100	90		0.04	3200
LQN21A15NK44	15												3100
LQN21A18NK44	18.8												2600
LQN21A21NK44	21												2200
LQN21A27NK44	27												900

LQN1A

Part Number	Inductance			Q			DC Resistance (Ω)	Self-resonant Frequency (MHz min.)	Allowable Current (mA)	Operating Temp. Range
	Nominal Value (nH)	Tolerance (%)	Test Frequency	Peak Value (Typ.)	Min. Value	Test Frequency				
LQN1A8N8J(K)04	8.8	±5 (±10)	100MHz	100	60	436MHz	0.029±40%	1000	750	-25 to +85°C
LQN1A15NJ(K)04	14.7						0.035±40%		680	
LQN1A17NJ(K)04	17						0.037±40%		650	
LQN1A23NJ(K)04	23						0.046±40%		590	
LQN1A27NJ(K)04	27						0.051±40%		560	
LQN1A33NJ(K)04	33						0.057±40%		530	
LQN1A39NJ(K)04	39						0.067±40%		490	
LQN1A47NJ(K)04	47						0.110±40%		380	
LQN1A56NJ(K)04	56						0.140±40%		330	
LQN1A64NJ(K)04	64						0.180±40%		290	
LQN1A84NJ(K)04	84						0.280±40%		240	
LQN1AR10J(K)04	100						0.300±40%		230	

■ TYPICAL ELECTRICAL CHARACTERISTICS

● Q-Frequency Characteristics

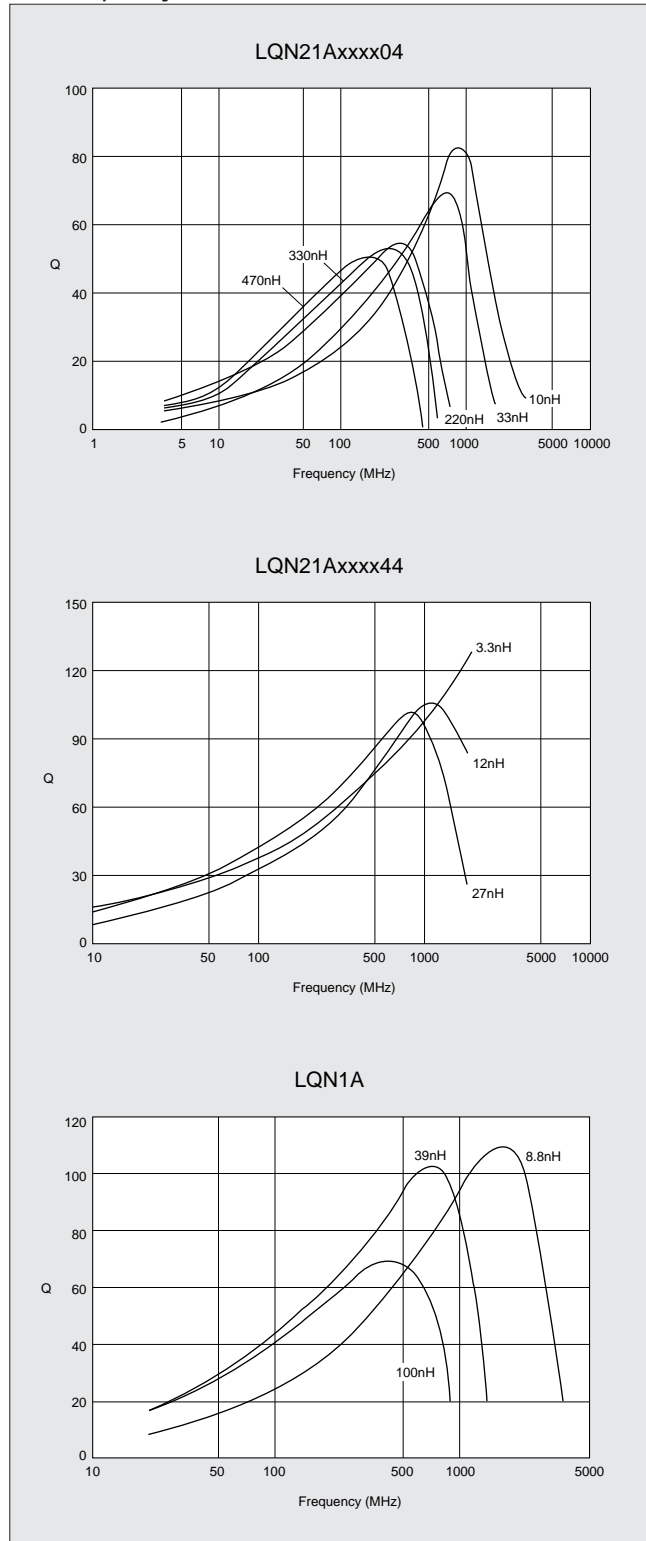

● Inductance-Frequency Characteristics

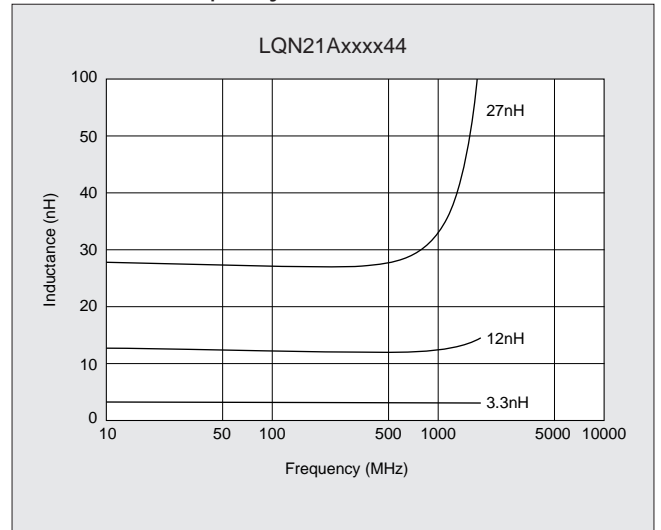

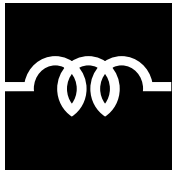

CHIP COIL



High Q Chip Coil **LQN1H** for High Frequency

Wire Wound Chip Coil with High Q from 30MHz to 150MHz and Stable Inductance

The LQN1H series consists of wire wound chip coils which use ferrite cores for high frequency application. Their high Q values from 30MHz to 150MHz and low DC resistance make them suitable in high-frequency resonator circuits.

FEATURES

1. Same dimensions as LQN1A/LQH1N/LQH1C series enables design flexibility.
2. Broad range of inductance 54 to 880nH.
3. High Q value and stable inductance at high frequency (30MHz to 150MHz).
4. Both flow and reflow soldering methods are applicable due to excellent solder heat resistance.
5. Miniature size (3.2X1.6X1.8mm) allows parallel mounting at 2.5mm pitch.

APPLICATIONS

- Voltage controlled oscillators, traps, and filter circuits in mobile communication equipments, cordless phones, various radio equipment, FM radio tuners, TV tuners (VHF low), VIF circuits.

TYPICAL ELECTRICAL CHARACTERISTICS

- Q-Frequency Characteristics

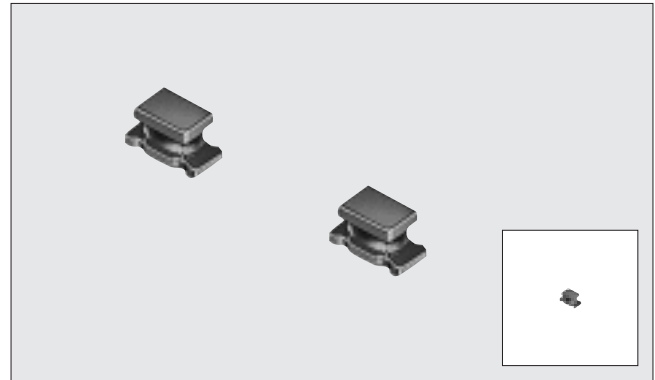
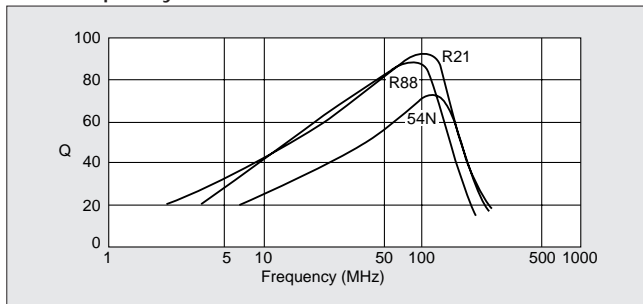

DIMENSIONS

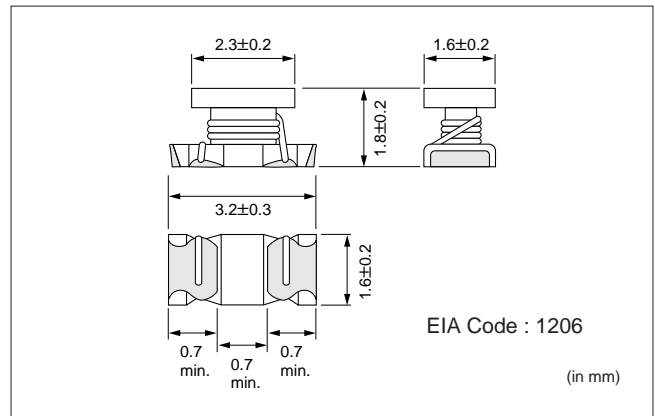

SPECIFICATIONS

Part Number	Inductance			Q			DC Resistance (Ω)	Self-resonant Frequency (MHz min.)	Allowable Current (mA)	Operating Temp. Range
	Nominal Value (nH)	Tolerance (%)	Test Frequency	Peak Value (Typ.)	Min. Value	Test Frequency				
LQN1H54NK04	54	±10	1MHz	65	50	100MHz	0.035±30%	800	920	-25 to +85°C
LQN1H95NK04	95			75			0.047±30%	650	790	
LQN1HR14K(J)04	145			80			0.061±30%	500	700	
LQN1HR21K(J)04	215	±10		85			0.11 ±30%	430	520	
LQN1HR29K(J)04	290						0.17 ±30%	360	420	
LQN1HR39K(J)04	390						0.26 ±30%	300	330	
LQN1HR50K(J)04	500	(±5)		85			0.44 ±30%	270	260	
LQN1HR61K(J)04	610						0.48 ±30%	240	250	
LQN1HR75K(J)04	750						0.79 ±30%	220	190	
LQN1HR88K(J)04	880			90			0.86 ±30%	200	180	

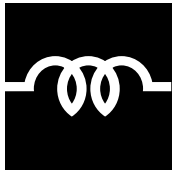

CHIP COIL



Miniature Chip Coil **LQH1C/LQH3C/LQH4C** Series for Power Line Choke

Miniature Chip Coil for Power Line Choke Has High Current Capacity, Low DC Resistance, Large Inductance

The LQH1C, LQH3C and LQH4C series consist of miniature chip coils with low DC resistance, high current capacity, and high impedance characteristics. These features are made possible by the development of Murata's innovative automatic winding techniques. They are excellent for use as choke coils in DC power supply circuits.

FEATURES

1. The LQH1C, LQH3C and LQH4C series have an open magnetic structure. The series have a combined inductance range of 0.12μH to 560μH and are applicable in a wide variety of applications.
2. The series exhibit low voltage drops and small variations in inductance with respect to temperature rise and DC current level. This makes them excellent for use as power supply line choke coils.
3. The series has excellent solder heat resistance. Both flow and reflow soldering methods can be employed.

● LQH1C

Miniature size (3.2×1.6×1.8mm) allows parallel mounting at 2.5mm pitch. Despite their small size, at 0.12μH these coils have a maximum current rating of 970mA.

● LQH3C

The low DC resistance means high current and high inductance.

For inductance ranging from 0.15μH to 10μH, LQH3C coils have very low DC resistance.

● LQH4C

The LQH4C has miniature size 4.5mm×3.2mm and realized low height 2.8mm max.

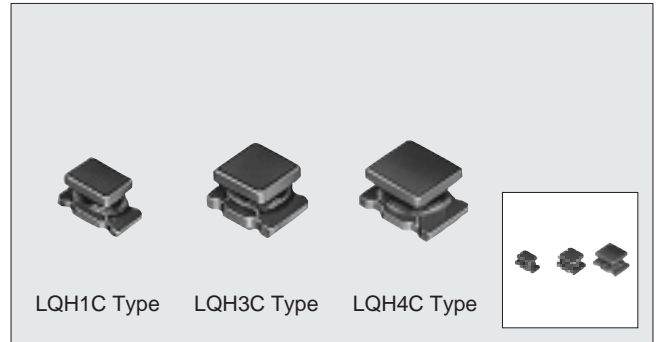

DIMENSIONS

LQH1C Type

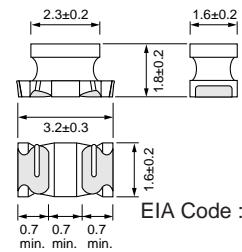

EIA Code : 1206

LQH3C xx24 Series

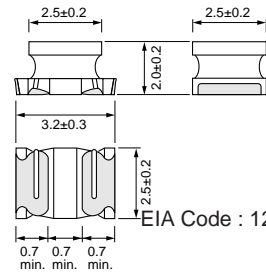

EIA Code : 1210

LQH3C xx34 Series

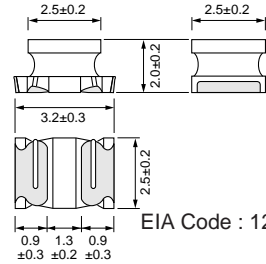

EIA Code : 1210

LQH4C Type

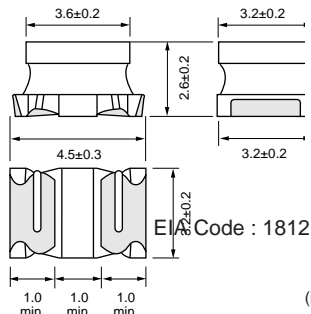

EIA Code : 1812

(in mm)

■SPECIFICATIONS

LQH1C

Part Number	Inductance			DC Resistance (Ω)	Self-resonant Frequency (MHz)		Allowable Current (mA)	Operating Temp. Range
	Nominal Value (μH)	Tolerance (%)	Test Frequency		Typ.	Min.		
LQH1CR12M04	0.12	±20	1MHz	0.08±40%	900	250	970	-25 to +85°C
LQH1CR22M04	0.22			570	850			
LQH1CR47M04	0.47			310	700			
LQH1C1R0M04	1.0			190	510			
LQH1C2R2M04	2.2			110	430			
LQH1C4R7M04	4.7			67	340			
LQH1C100K04	10	±10	1MHz	1.3 ±30%	42	20	230	
LQH1C220K04	22			3.0 ±30%	26	14	160	
LQH1C470K04	47			8.0 ±30%	18	10	100	
LQH1C101K04	100			12.0 ±30%	12	7	80	

LQH3C

Part Number	Inductance			DC Resistance (Ω)	Self-resonant Frequency (MHz)		Allowable Current (mA)	Operating Temp. Range
	Nominal Value (μH)	Tolerance (%)	Test Frequency		Typ.	Min.		
LQH3CR15M24*	0.15	±20	1MHz	0.028±30%	680	400	1450	-25 to +85°C
LQH3CR27M24*	0.27			0.034±30%	490	250	1250	
LQH3CR47M24*	0.47			0.042±30%	370	150	1100	
LQH3C1R0M24*	1.0			0.060±30%	200	100	1000	
LQH3C2R2M24*	2.2			0.097±30%	120	64	790	
LQH3C4R7M24*	4.7			0.15 ±30%	77	43	650	
LQH3C100K24*	10	±10	1MHz	0.30 ±30%	50	26	450	
LQH3C1R0M34	1.0	±20		0.09 ±30%	150	96	800	
LQH3C2R2M34	2.2			0.13 ±30%	100	64	600	
LQH3C4R7M34	4.7			0.20 ±30%	66	43	450	
LQH3C100K34	10	±10		0.44 ±30%	40	26	300	
LQH3C220K34	22			0.71 ±30%	27	19	250	
LQH3C470K34	47			1.3 ±30%	19	15	170	
LQH3C101K34	100			3.5 ±30%	13	10	100	
LQH3C221K34	220			8.4 ±30%	8.5	6.8	70	
LQH3C331K34	330			10.0 ±30%	7.0	5.6	60	
LQH3C391K34	390	1kHz		17.0 ±30%	6.6	5.0		
LQH3C471K34	470			19.0 ±30%	6.2			
LQH3C561K34	560	22.0 ±30%	5.7					

*Low DC Resistance type.

LQH4C

Part Number	Inductance			DC Resistance (Ω max.)	Self-resonant Frequency (MHz)	Allowable Current (mA)	Operating Temp. Range
	Nominal Value (μH)	Tolerance (%)	Test Frequency				
LQH4C1R0M04	1.0	±20	1MHz	0.08	100	1080	-25 to +85°C
LQH4C1R5M04	1.5			0.09	85	1000	
LQH4C2R2M04	2.2			0.11	60	900	
LQH4C3R3M04	3.3			0.13	47	800	
LQH4C4R7M04	4.7			0.15	35	750	
LQH4C6R8M04	6.8			0.20	30	720	
LQH4C100K04	10	±10		0.24	23	650	
LQH4C150K04	15			0.32	20	570	
LQH4C220K04	22			0.6	15	420	
LQH4C330K04	33			1.0	12	310	
LQH4C470K04	47			1.1	10	280	
LQH4C680K04	68			1.7	8.4	220	
LQH4C101K04	100		2.2	6.8	190		
LQH4C151K04	150		3.5	5.5	130		
LQH4C221K04	220		4.0	4.5	110		
LQH4C331K04	330		6.8	3.6	100		
LQH4C471K04	470		1kHz	8.5	3.0	90	

■ TYPICAL ELECTRICAL CHARACTERISTICS

● Impedance - Frequency Characteristics

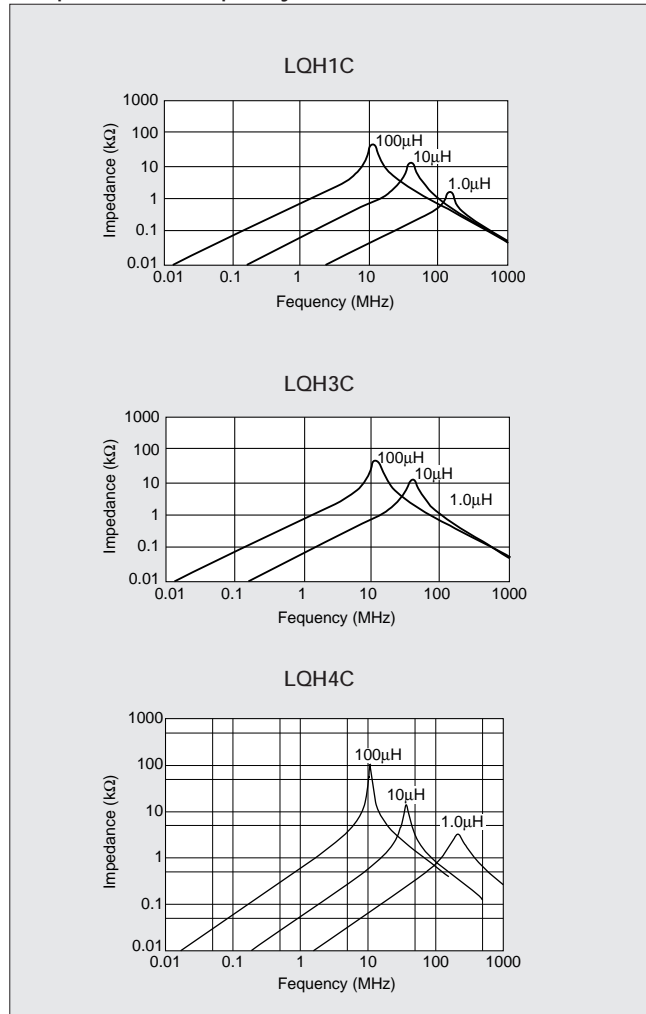

● Direct Current Characteristics

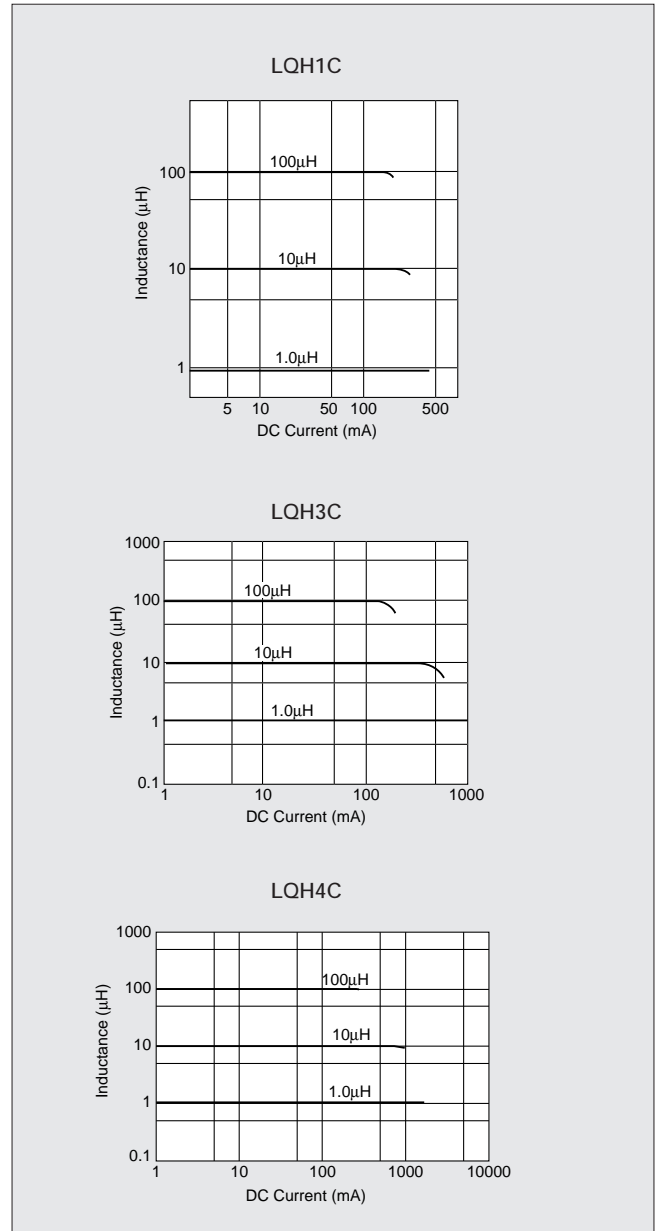

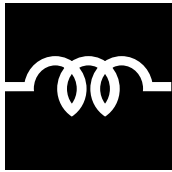

CHIP COIL



Multilayer Chip Coil **LQG21C** Series

Low DC Resistance Choke for Power Lines Has Magnetically Shielded Structure

The LQG21C series consists of magnetically shielded chip coil developed with original Murata multilayer process technology and incorporating magnetic materials. It has less than half the DC resistance of our conventional multilayer chip coils as well as high inductance.

■FEATURES

1. The inductors have very low DC resistance.
2. The series has an inductance range of 1.0μH to 47μH.
3. Magnetically shielded structure provides excellent crosstalk characteristics.
4. Compact (2.0×1.25mm) and lightweight.
5. Outstanding solder heat resistance. Either flow or reflow soldering methods can be employed.

■APPLICATIONS

- Power lines (for choke use)

■TYPICAL ELECTRICAL CHARACTERISTICS

- Impedance-Frequency Characteristics

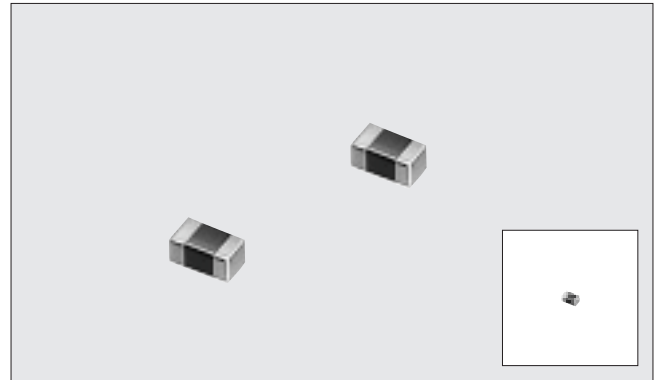
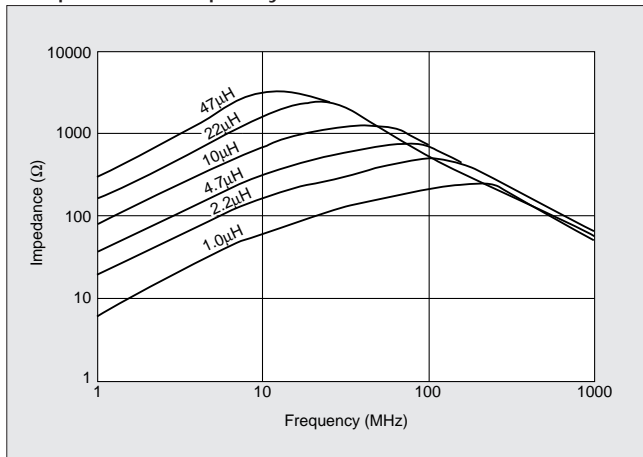

■DIMENSIONS

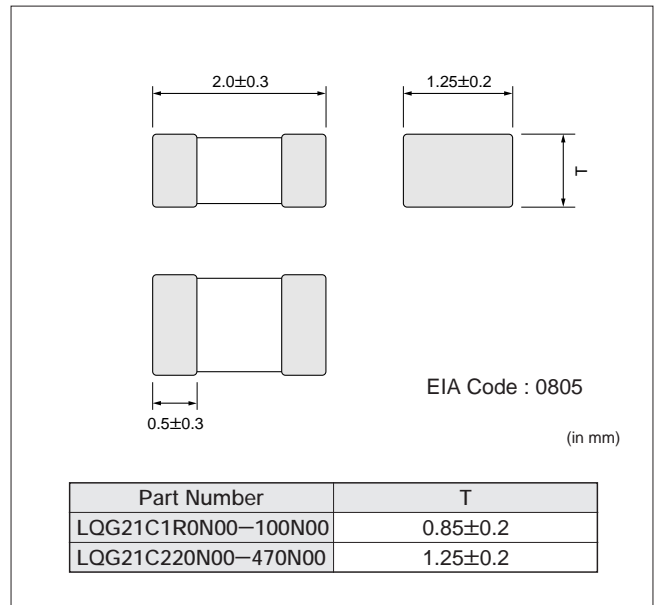

■SPECIFICATIONS

Part Number	Inductance			DC Resistance (Ω max.)	Self-resonant Frequency (MHz)		Allowable Current (mA)	Operating Temp. Range
	Nominal Value (μH)	Tolerance (%)	Test Frequency		Typ.	Min.		
LQG21C1R0N00	1.0	±30	1MHz	0.10	150	75	60	-40 to +85°C
LQG21C2R2N00	2.2			0.17	100	50	40	
LQG21C4R7N00	4.7			0.30	70	35	30	
LQG21C100N00	10			0.50	45	24	15	
LQG21C220N00	22			0.65	20	16	13	
LQG21C470N00	47			1.20	-	7.5	7	

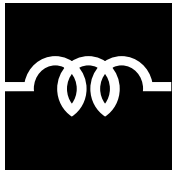

CHIP COIL



Multilayer Chip Coil **LQG21F** Series

Magnetically Shielded Multilayer Chip Coil for Choke with Excellent Direct Current Characteristics

LQG21F series consists of magnetically shielded chip coils based on Murata's technologies of multilayer process and magnetic materials. Excellent direct current characteristics are realized by using magnetic materials which have excellent saturation characteristics. The inductance of LQG21F is four times as large as that of conventional items.

■FEATURES

1. LQG21F series is suitable for power line choke because of its excellent direct current characteristics. The series has larger rated current (60mA at 10μH) than conventional rated current.
2. Low DC resistance is realized.
3. The cross talk characteristics are excellent because of the use of magnetically shielded structure.
4. Small size (2.0×1.25mm) and light weight.
5. The series has excellent solder heat resistance. Both flow and reflow soldering can be employed.

■APPLICATIONS

- Circuits for DC power line choke of telecommunication equipment such as DVC, digital camera, PDA, MD and DVD-RAM.

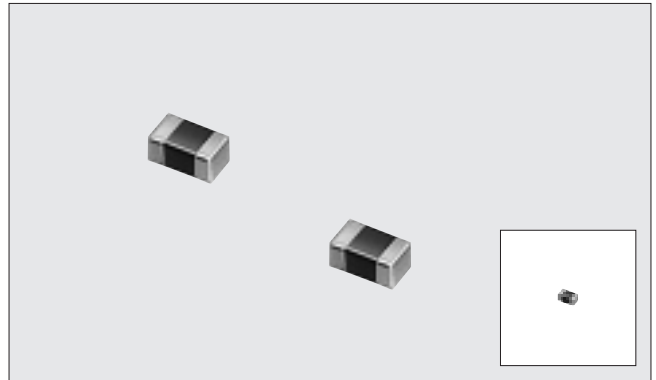

■DIMENSIONS

EIA Code : 0805
(in mm)

Part Number	T
LQG21F1R0N00-2R2N00	0.85±0.2
LQG21F4R7N00-470N00	1.25±0.2

■SPECIFICATIONS

Part Number	Inductance			DC Resistance (Ω ±30%)	Self-resonant Frequency (MHz Min.)	Allowable Current (mA)	Operating Temp. Range
	Nominal Value (μH)	Tolerance (%)	Test Frequency				
LQG21F1R0N00	1.0	±30	1MHz	0.20	105	220	-40 to +85°C
LQG21F2R2N00	2.2			0.28	70	150	
LQG21F4R7N00	4.7			0.30	25	80	
LQG21F100N00	10			0.50	15	60	
LQG21F220N00	22			0.35	15	13	
LQG21F470N00	47			0.60	7.5	7	

■ TYPICAL ELECTRICAL CHARACTERISTICS

● Impedance Frequency Characteristics

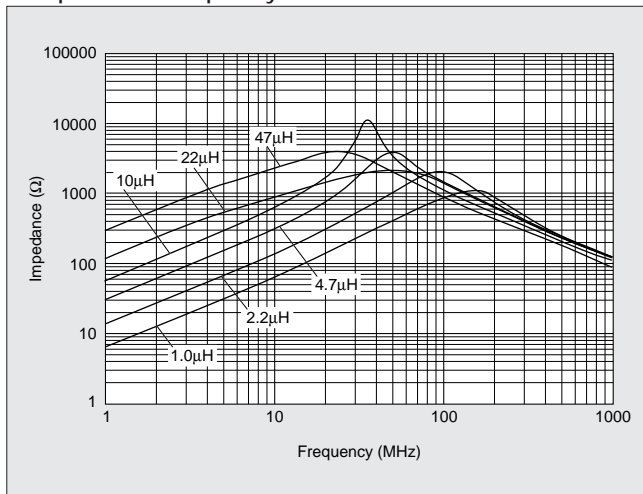

● Direct Current Characteristics

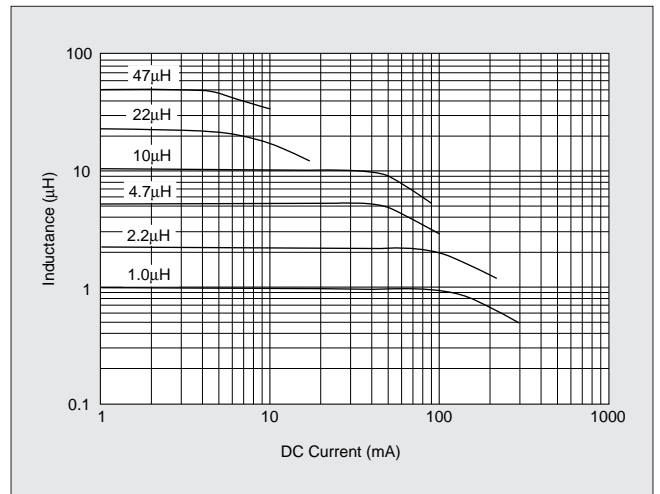

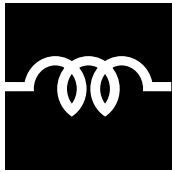

CHIP COIL



Multilayer Chip Coil **LQG3216F** Series

Magnetically Shielded Multilayer Thin Type Chip Coil with Excellent Direct Current Characteristics

LQG3216F series consists of magnetically shielded chip coils based on Murata's technologies of multilayer process and magnetic materials. Excellent direct current characteristics and low DC resistance are realized by using magnetic materials which have excellent saturation characteristics and high permeability.

■FEATURES

1. LQG3216F series is suitable for power line choke because of its excellent direct current characteristics and large rated current. (70mA at 10μH)
2. Low DC resistance is realized.
3. The cross talk characteristics are excellent because of magnetically shielded structure.
4. Low profile 1.0mm.
5. The series has excellent solder heat resistance. Both flow and reflow soldering can be employed.

■APPLICATIONS

- Circuits for DC power line choke of telecommunication equipments such as PDA, Note-PC, digital camera, PDA, DVC, MD and DVD-RAM.

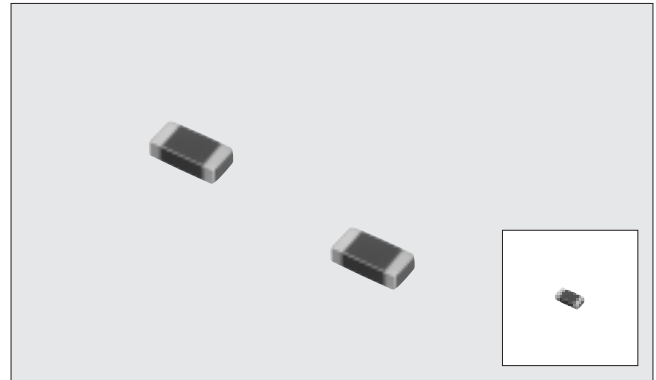

■DIMENSIONS

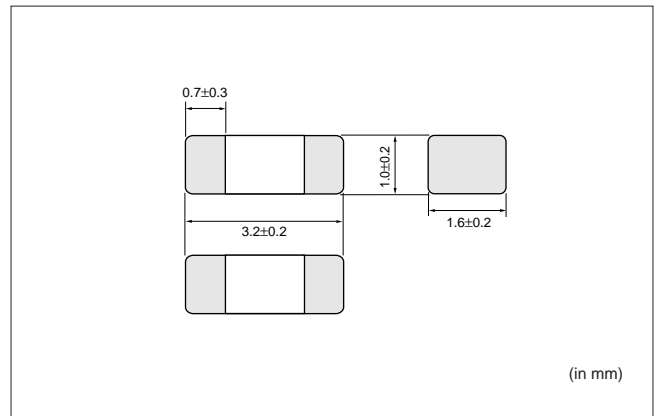

■SPECIFICATIONS

Part Number	Inductance			DC Resistance (Ω max.)	Self-resonant Frequency (MHz Min.)	Allowable Current (mA)	Operating Temp. Range
	Nominal Value (μH)	Tolerance (%)	Test Frequency				
LQG3216F100M00	10	±20	1MHz	0.50	20	70	-40 to +85°C

■ TYPICAL ELECTRICAL CHARACTERISTICS

● Impedance Frequency Characteristics

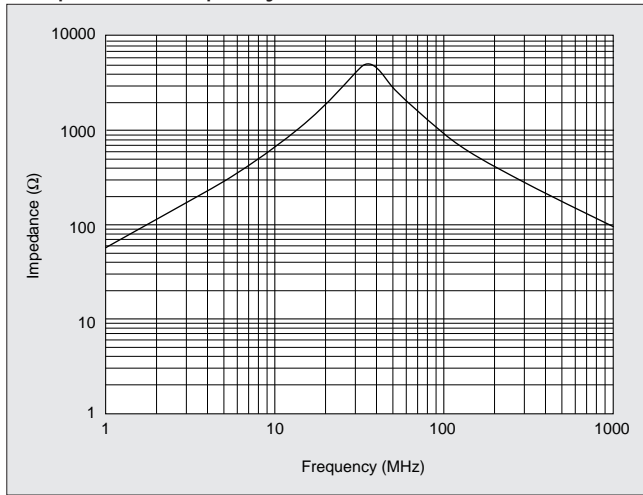

● Direct Current Characteristics

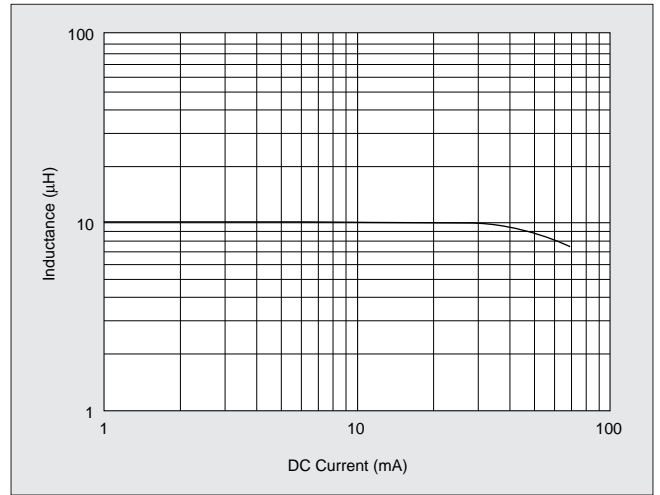

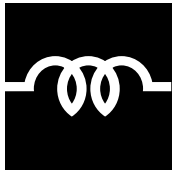

CHIP COIL



Magnetically Shielded Choke Coil **LQS33C** Series

Small Size, Low Profile and Magnetically Shielded Chip Coil for Choke Excellent for EL Back Light Driver Circuit

■FEATURES

1. Low profile dimension (2.1mm max.) and small size of 1212 (3.3×3.3mm) is suitable for portable equipment.
2. The series have low DC Resistance.
3. LQS33C series have large inductance of 560μH to 2200μH.
4. Magnetically shielded structure prevents interference occurring between peripheral components.

■APPLICATIONS

- For EL back light driver circuit

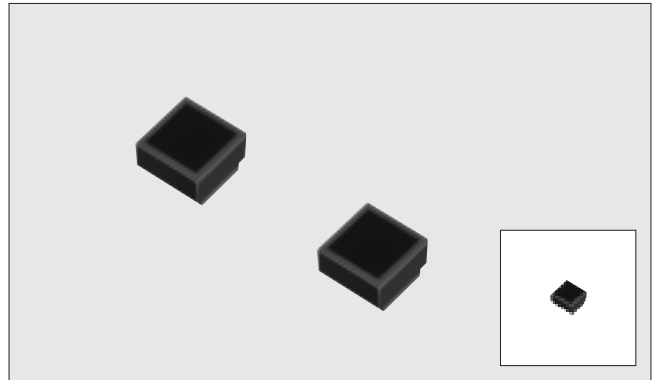

■DIMENSIONS

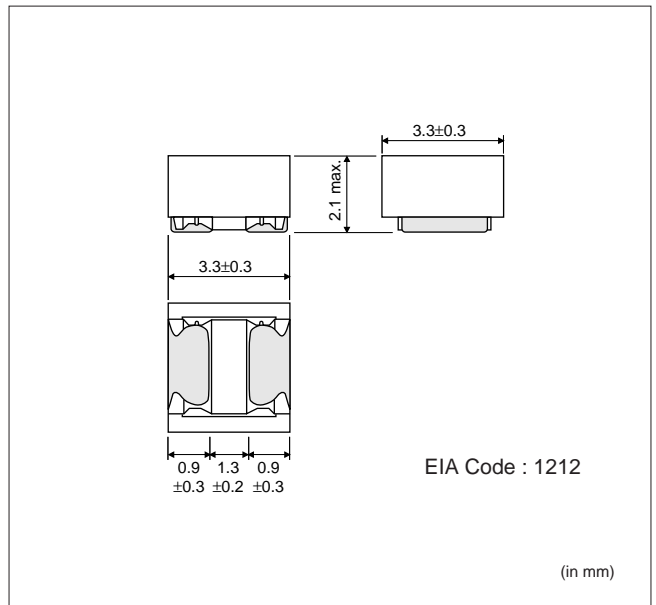

■SPECIFICATIONS

Part Number	Inductance			DC Resistance (Ω ±30%)	Self-resonant Frequency (MHz Min.)	Allowable Current (mA)	Operating Temp. Range
	Nominal Value (μH)	Tolerance (%)	Test Frequency				
LQS33C561N34	560	±30	100kHz	7.8	3.0	50	-25 to +85°C
LQS33C681N34	680			9.1	2.6	40	
LQS33C102N34	1000		10kHz	11	2.1	30	
LQS33C152N34	1500			23	1.7	25	
LQS33C222N34	2200			28	1.5	20	

■ TYPICAL ELECTRICAL CHARACTERISTICS

● Impedance Frequency Characteristics

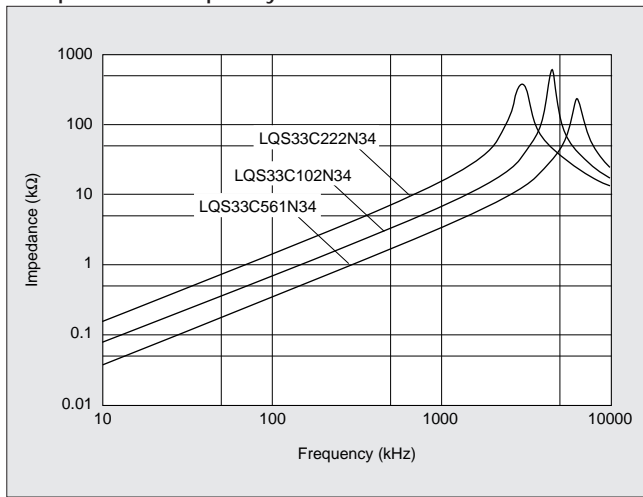

● Direct Current Characteristics

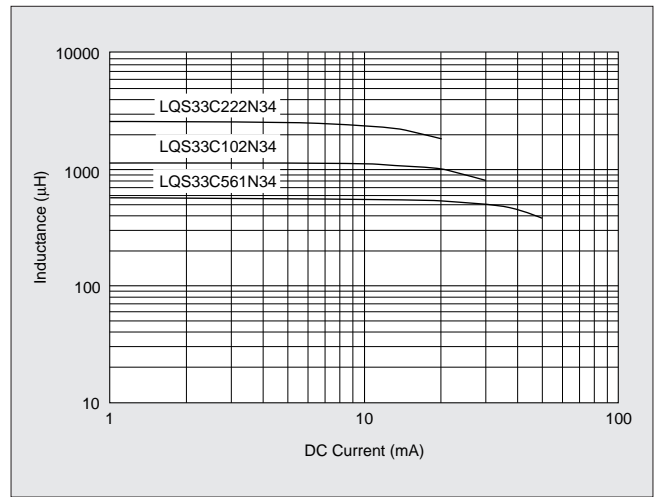

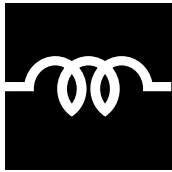

CHIP COIL



Large Current Choke Coil **LQN6C/LQS66C** Series

Choke Coil for DC/DC Converters and DC Power Lines with Low DC Resistance, Large Current Capacity and Large Inductance

The LQN6C/LQS66C series are choke coils which have achieved low direct current resistance, large current capacity and large inductance by using high performance thick wire wrapping technology. Because the LQS66C series has a shielded construction, it can be mounted in high density without interference occurring between peripheral components. They are optimum for use as choke coils in DC/DC converters and DC power supply circuits.

■FEATURES

1. Both the LQN6C series with its open magnetic path construction and the LQS66C series with its magnetic shielding construction allow application to a wide variety of uses.
2. The inductance range covers from 0.12μH up to 10000μH allowing minute compatibility with the E6 series at 1μH to 1000μH.
3. Because the direct current resistance is small as well as the voltage drop and power consumption being small also, they are optimum for use as choke coils for DC power supply circuits.

■APPLICATIONS

- Camcorders, portable AV equipment, etc.
- DC/DC converters and DC power supplies.

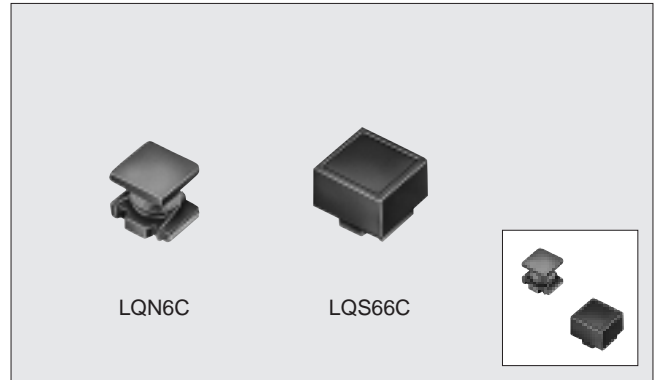

■DIMENSIONS

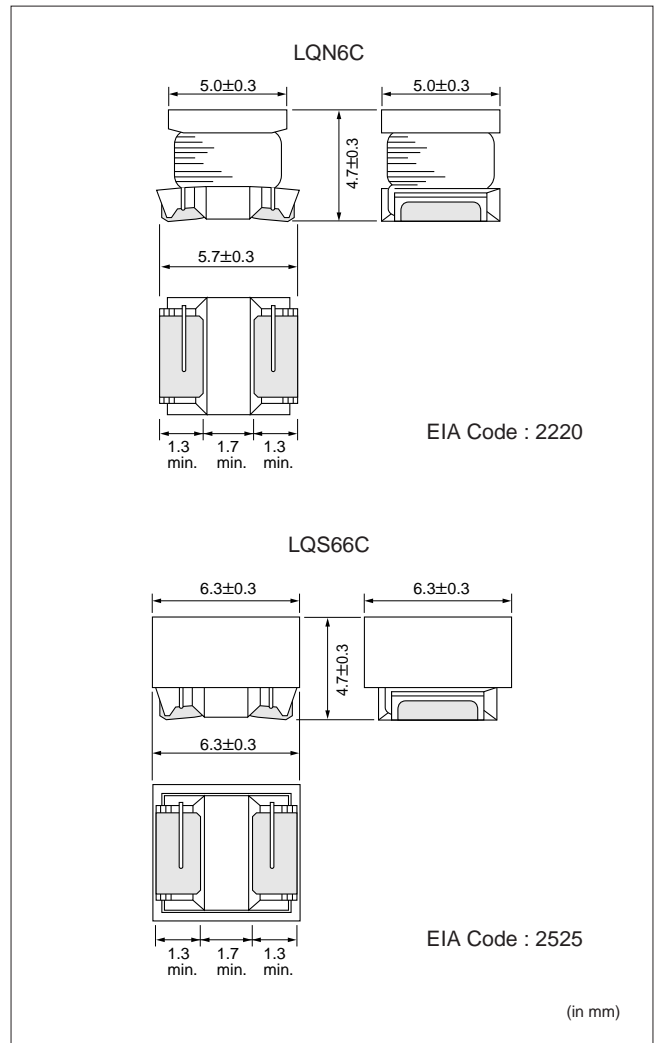

■SPECIFICATIONS

LQN6C

Part Number	Inductance			DC Resistance ($\Omega \pm 40\%$)	Self-resonant Frequency (MHz min.)	Allowable Current (A)	Operating Temp. Range
	Nominal Value (μH)	Tolerance (%)	Test Frequency				
LQN6CR12M04	0.12	±20	1MHz	0.007	450	6.0	-25 to +80°C
LQN6CR27M04	0.27			0.010	300	5.3	
LQN6CR47M04	0.47			0.013	200	4.8	
LQN6C1R0M04	1.0			0.019	150	4.0	
LQN6C1R5M04	1.5			0.022	110	3.7	
LQN6C2R2M04	2.2			0.029	80	3.2	
LQN6C3R3M04	3.3			0.036	40	2.9	
LQN6C4R7M04	4.7			0.041	30	2.7	
LQN6C6R8M04	6.8			0.074	25	2.0	
LQN6C100M04	10			0.093	20	1.7	
LQN6C150M04	15			0.15	17	1.4	
LQN6C220M04	22			0.19	15	1.2	
LQN6C330M04	33			0.32	12	0.9	
LQN6C470M04	47			0.40	10	0.8	
LQN6C680M04	68			0.67	7.6	0.64	
LQN6C101M04	100			0.86	6.5	0.56	
LQN6C151M04	150			1.9	5.0	0.42	
LQN6C221M04	220			2.4	4.0	0.32	
LQN6C331M04	330		4.4	3.1	0.27		
LQN6C471M04	470		5.4	2.4	0.24		
LQN6C681M04	680		8.1	1.9	0.19		
LQN6C102M04	1000		10.3	1.7	0.15		
LQN6C222M04	2200		21.5	1.2	0.10		
LQN6C472M04	4700		43.6	0.8	0.07		
LQN6C103M04	10000		100	0.5	0.05		

LQS66C

Part Number	Inductance			DC Resistance ($\Omega \pm 40\%$)	Self-resonant Frequency (MHz min.)	Allowable Current (A)	Operating Temp. Range
	Nominal Value (μH)	Tolerance (%)	Test Frequency				
LQS66CR27M04	0.27	±20	1MHz	0.007	300	6.0	-25 to +80°C
LQS66CR68M04	0.68			0.010	180	5.3	
LQS66C1R0M04	1.0			0.013	150	4.7	
LQS66C1R5M04	1.5			0.016	110	3.8	
LQS66C2R2M04	2.2			0.019	80	3.3	
LQS66C3R3M04	3.3			0.022	40	2.6	
LQS66C4R7M04	4.7			0.025	30	2.2	
LQS66C6R8M04	6.8			0.029	25	1.8	
LQS66C100M04	10			0.036	20	1.6	
LQS66C150M04	15			0.069	17	1.3	
LQS66C220M04	22			0.087	15	1.1	
LQS66C330M04	33			0.14	12	0.86	
LQS66C470M04	47			0.17	10	0.76	
LQS66C680M04	68			0.29	7.6	0.60	
LQS66C101M04	100			0.36	6.5	0.52	
LQS66C151M04	150			0.63	5.0	0.42	
LQS66C221M04	220			0.79	4.0	0.35	
LQS66C331M04	330			1.8	3.2	0.28	
LQS66C471M04	470		2.2	2.5	0.24		
LQS66C681M04	680		3.9	2.0	0.20		
LQS66C102M04	1000		4.9	1.7	0.16		
LQS66C222M04	2200		9.4	1.2	0.10		
LQS66C472M04	4700		19.5	0.8	0.07		
LQS66C103M04	10000		39.7	0.5	0.05		

■ TYPICAL ELECTRICAL CHARACTERISTICS

● Impedance - Frequency Characteristics

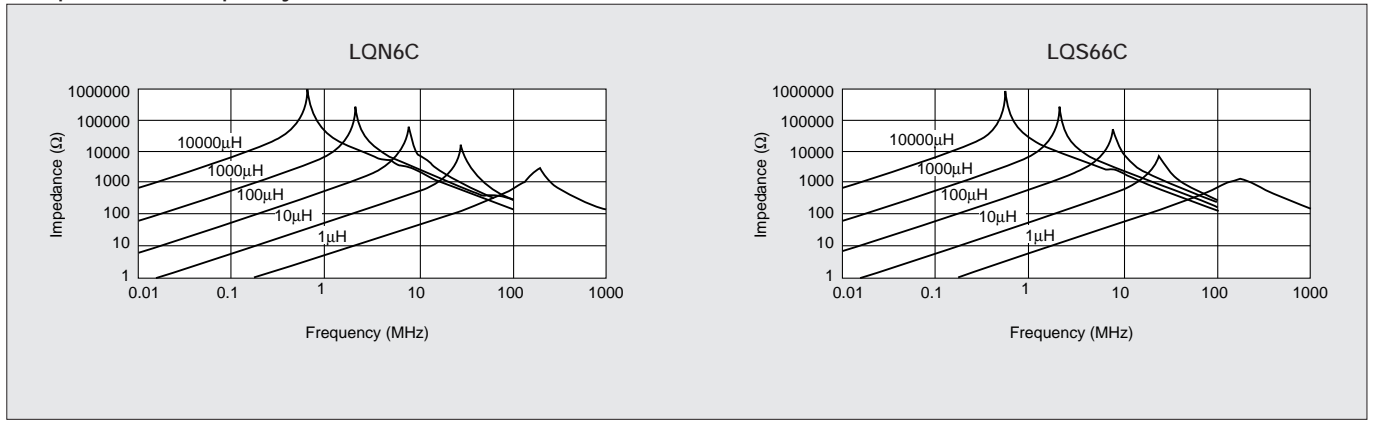

● Direct Current Characteristics

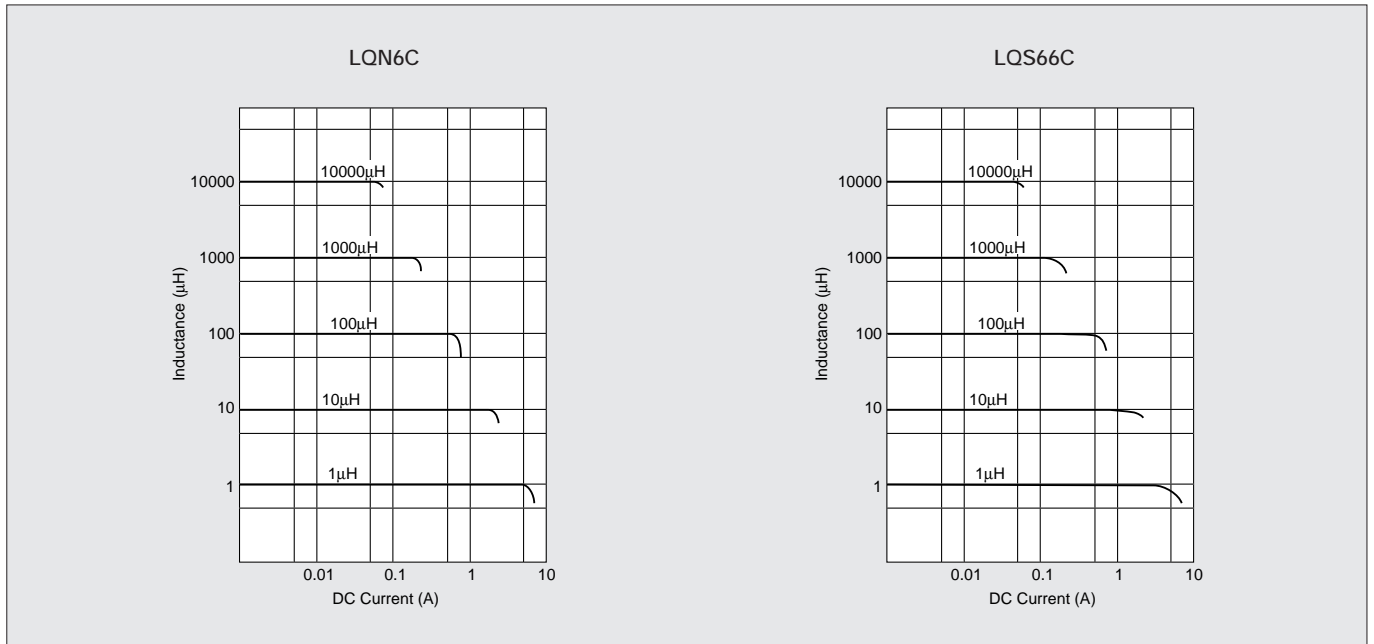









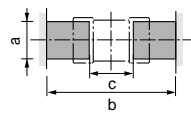

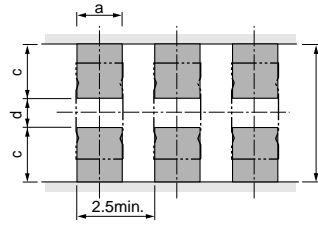
Notice of Chip Coil

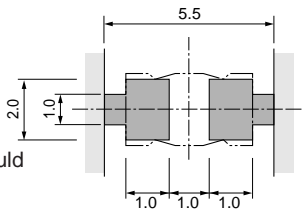
1. Standard Land Dimensions

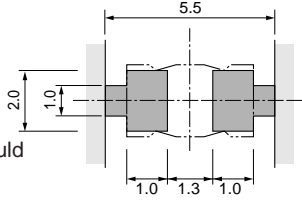
A high Q value is achieved when the PCB electrode land pattern is designed so that it does not project beyond the chip coil electrode.

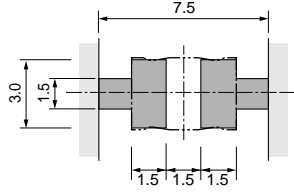
Land Solder Resist (in mm)

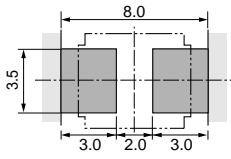
Series	Standard Land Dimensions (Flow and Reflow)																																				
LQG11N LQG21N LQG21C LQG21F LQG3216F LQP10A/11A LQG10A/11A 				<table border="1"> <thead> <tr> <th>Type</th> <th>a</th> <th>b</th> <th>c</th> </tr> </thead> <tbody> <tr> <td>LQG10A</td> <td>0.5-0.6</td> <td>1.4-1.5</td> <td>0.4</td> </tr> <tr> <td>LQG11A</td> <td>0.6-0.8</td> <td>1.8-2.2</td> <td>0.6-0.8</td> </tr> <tr> <td rowspan="2">LQG11N</td> <td rowspan="2">0.7</td> <td>2.2-2.6</td> <td rowspan="2">0.7</td> </tr> <tr> <td>1.8-2.0</td> </tr> <tr> <td>LQG21N/21C/21F</td> <td>1.0</td> <td>3.0-4.0</td> <td>1.2</td> </tr> <tr> <td>LQP10A</td> <td>0.5-0.6</td> <td>1.4-1.5</td> <td>0.4</td> </tr> <tr> <td>LQP11A</td> <td>0.7</td> <td>2.6</td> <td>0.6</td> </tr> <tr> <td>LQG3216F</td> <td>1.2</td> <td>4.2-5.2</td> <td>2.0</td> </tr> </tbody> </table>	Type	a	b	c	LQG10A	0.5-0.6	1.4-1.5	0.4	LQG11A	0.6-0.8	1.8-2.2	0.6-0.8	LQG11N	0.7	2.2-2.6	0.7	1.8-2.0	LQG21N/21C/21F	1.0	3.0-4.0	1.2	LQP10A	0.5-0.6	1.4-1.5	0.4	LQP11A	0.7	2.6	0.6	LQG3216F	1.2	4.2-5.2	2.0
Type	a	b	c																																		
LQG10A	0.5-0.6	1.4-1.5	0.4																																		
LQG11A	0.6-0.8	1.8-2.2	0.6-0.8																																		
LQG11N	0.7	2.2-2.6	0.7																																		
		1.8-2.0																																			
LQG21N/21C/21F	1.0	3.0-4.0	1.2																																		
LQP10A	0.5-0.6	1.4-1.5	0.4																																		
LQP11A	0.7	2.6	0.6																																		
LQG3216F	1.2	4.2-5.2	2.0																																		
LQH1N/1C LQN1A/1H LQN21A LQW1608A 	If mounted at 2.5mm intervals as indicated in the diagram at left, attention should be paid to potential magnetic coupling effects when using the coil as a resonator. Refer to the coupling factor graph in the typical electrical characteristics section. (LQW1608A : Reflow soldering should be applied.)	 <table border="1"> <thead> <tr> <th>Type</th> <th>a</th> <th>b</th> <th>c</th> <th>d</th> </tr> </thead> <tbody> <tr> <td>LQH1N/1C</td> <td>1.5</td> <td>4.5</td> <td>1.75</td> <td>1.0</td> </tr> <tr> <td>LQN1A/1H</td> <td></td> <td></td> <td></td> <td></td> </tr> <tr> <td>LQN21A</td> <td>1.2</td> <td>3.0</td> <td>1.1</td> <td>0.8</td> </tr> <tr> <td>LQW1608A</td> <td>0.7-1.0</td> <td>1.8-2.0</td> <td>0.6-0.7</td> <td>0.6-0.8</td> </tr> </tbody> </table>			Type	a	b	c	d	LQH1N/1C	1.5	4.5	1.75	1.0	LQN1A/1H					LQN21A	1.2	3.0	1.1	0.8	LQW1608A	0.7-1.0	1.8-2.0	0.6-0.7	0.6-0.8								
Type	a	b	c	d																																	
LQH1N/1C	1.5	4.5	1.75	1.0																																	
LQN1A/1H																																					
LQN21A	1.2	3.0	1.1	0.8																																	
LQW1608A	0.7-1.0	1.8-2.0	0.6-0.7	0.6-0.8																																	
LQH3Cxx24 Series LOS33N 	(LQS33N : Reflow soldering should be applied.)																																				
LQH3N LQH3Cxx34 Series LOS33C 	(LQS33C : Reflow soldering should be applied.)																																				
LQH4N LQN4N LQH4C 																																					
LQN6C LQS66C 	(LQN6C/LQS66C : Reflow soldering should be applied.)																																				

Notice of Chip Coil

2. Mounting Instructions

① Land Pattern Dimensions

Large lands reduce Q of the mounted chip. Also, large protruding land areas (bordered by lines having dimensions c and d shown below) cause floating and electrode cracks.

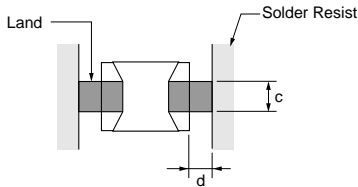

② Magnetic Coupling

Since some chip coils are constructed like an open magnetic circuit, narrow spacing between coils may cause magnetic coupling.

(Please refer to Page 54 for coil-to-coil spacing and coupling coefficient.)

The LQS and LQG series have a magnetically shielded structure. The structure makes their coupling coefficient smaller than that of conventional chip coils. In particular, the LQS33N series has a very small coupling coefficient.

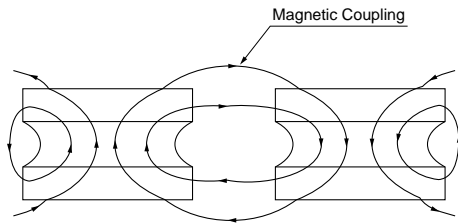

③ PCB Warping

Arrange chip coils to minimize stress caused by PCB warping.

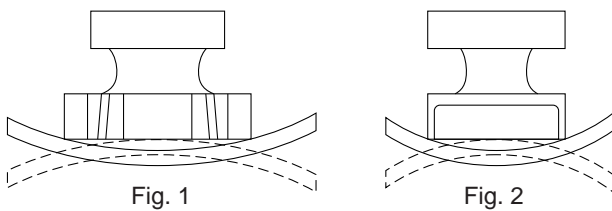

The arrangement shown in Fig. 2 is more effective in preventing stress than that shown in Fig. 1.

④ Amount of Solder Paste

Excessive solder causes electrode corrosion, while insufficient solder causes low electrode bonding strength. Adjust the amount of solder paste so that solder is applied as shown below.

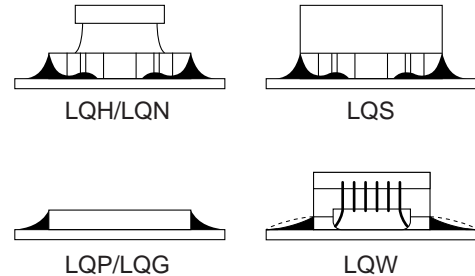

- Standard thickness of solder paste : 200 to 300µm (LQP10A : 100µm, LQG Series, LQP11A/LQW1608A : 100µm to 150µm)

⑤ Amount of Adhesive

If too much adhesive is applied, then it may overflow into the land or termination areas and yield poor solderability. In contrast, if insufficient adhesive is applied, or if the adhesive is not sufficiently hardened, then the chip may become detached during flow soldering. Apply the adhesive in accordance with the following conditions.

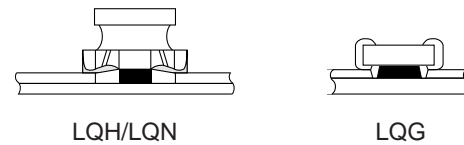

	Typical Application Amount (in mg)		
	MR-8153RA	NF-3000	UVS-50R-2
LQG11N	0.05-0.06	0.06-0.07	0.06-0.07
LQG21N/21C/21F	0.15-0.20	0.20-0.25	0.20-0.25
LQG3216F	0.20-0.25	0.25-0.30	0.25-0.30
LQN21A	0.16-0.18	0.21-0.23	0.21-0.23
LQH1N/1C	0.18-0.20	0.20-0.25	0.20-0.25
LQN1A/1H	0.20-0.23	0.27-0.35	0.27-0.35
LQH3N/3C	0.20-0.23	0.27-0.35	0.27-0.35
LQH(N)4N/4C	0.45-0.50	0.60-0.80	0.60-0.80

Notice of Chip Coil

3. Standard Soldering Conditions

① Soldering Method

Chip coils can be flow or reflow soldered. (LQS33N, LQS66C and LQP11A should only be reflow soldered)
Please contact Murata regarding other soldering methods.
The volume of solder can cause minor fluctuations in inductance value. Therefore, carefully control the amount of solder when soldering the LQP10A/11A, LQG10A/11A and LQW1608A series.

② Soldering Temperature and Time

Solder within the temperature and time combinations indicated by the slanted lines in the following graphs. If soldering is repeated, please note that the allowed time is the accumulated time.

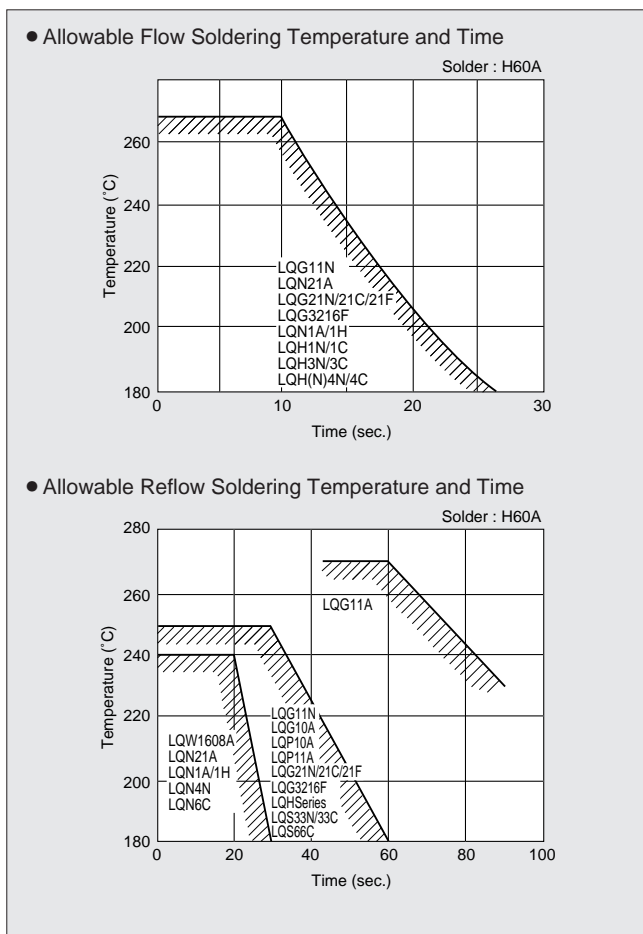

③ Solder and Flux

Solder : Use H60A, H63A, (JIS Z 3282) or equivalent.

Use solder paste equivalent to H60A for LQP10A/11A and LQG10A/11A.

Flux : Use rosin-based flux, but not strongly acidic flux (with chlorine content exceeding 0.2wt%).
Do not use water - soluble flux.

④ Standard Soldering Conditions

● Flow Solder

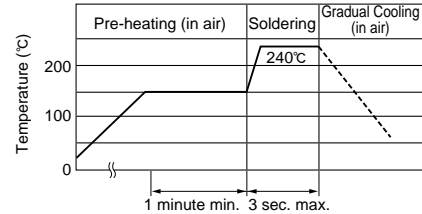

● Reflow Solder

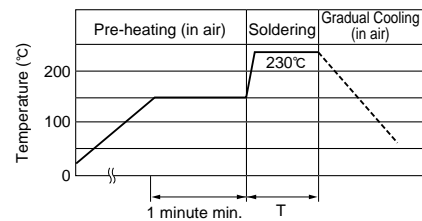

Series	Pre-heating (150°C)	Soldering Time (T)	Soldering Temp. (°C)		
LQG21N/21C/21F	60 sec. min.	10 sec. max.	230		
LQG3216F					
LQH1N/1C					
LQN1A/1H					
LQW1608A					
LQN21A					
LQH3N/3C					
LQH4N/LQN4N/LQH4C					
LQS33N/33C					
LQN6C/LQS66C					
LQG10A/11A/LQP10A/11A				20 sec. max.	

⑤ Reworking with Soldering Iron

Preheating at 150°C for 1minute is required. Do not directly touch the ceramic element with the tip of the soldering iron. The reworking soldering conditions are as follows.

- Soldering iron power output : 30W max.
- Temperature of soldering iron tip : 280°C
- Diameter of soldering iron end : 3.0mm max.
- Soldering time : within 3 sec.

Notice of Chip Coil

4. Cleaning

The following conditions should be observed when cleaning chip coils.

- ① Cleaning Temperature : 60°C max. (40°C max. for CFC alternatives and alcohol cleaning agents)
- ② Ultrasonic
 - Output : 20W/ℓ max.
 - Duration : 5 minutes max.
 - Frequency : 28 to 40kHz
 - Care should be taken not to cause resonance of the PCB and mounted products.
- ③ Cleaning Agent

The following cleaning agents have been tested on individual components. Evaluation in complete assembly should be done prior to production.

 - a) CFC alternatives and alcohol cleaning agents
 - Isopropyl alcohol (IPA)
 - HCFC-225
 - b) Aqueous cleaning agents
 - Surface active agent (Clean Thru 750H)
 - High grade alcohol (Pine Alpha ST-100S)
 - Hydrocarbon (Techno Cleaner 335)
 - Alkaline saponifier (Aqua Cleaner 240-cleaner should be diluted to 20% using deionized water.)
 - LQS series : Aqueous agents should not be used because they may cause quality deterioration.
 - LQH series : Surface active agent and high grade alcohol can be used.
- ④ Ensure that flux residue is completely removed.

Component should be thoroughly dried after aqueous agents have been removed with deionized water.

For additional cleaning methods, please contact Murata.

5. Resin Coating

When coating products with resin, the relatively high resin curing stress may change inductance values.

For exterior coating, select resin carefully so that electrical and mechanical performance of the product is not affected.

6. Caution for Use

This item is designed to have sufficient strength, but handle with care not to make it chipped or broken due to its ceramic structure.

- LQW Series
 - Sharp material, such as a pair of tweezers, shall not touch to the winding portion to prevent the breaking of wire.
 - Do not give excessive mechanical shock to the products mounted on the board to prevent the breaking of the core.
 - In some mounting machines, when picking up components support pin pushes up the components from the bottom of base tape. In this case, please remove the support pin. The support pin may damage the components and break wire.
- LQH/LQN Series
 - Sharp material, such as a pair of tweezers, shall not touch to the winding portion to prevent the breaking of wire.
 - Do not give excessive mechanical shock to the products mounted on the board to prevent the breaking of the core.

- LQP Series
 - The pattern of the chip coil is covered with the protection film. But the handling the chip coil shall be taken care so that the chip coil would not be damaged with the pick-up nozzle, the sharp substance and so on.
- LQG□N/□C/□F Series
 - There is possibility that the inductance value change due to magnetism. Don't use a magnet or a pair of tweezers with magnetism when chip coil are handled. (The tip of the tweezers should be molded with resin or pottery.)

7. Handling

- ① Avoid applying excessive stress to products to prevent damage.
- ② Do not touch winding with sharp objects such as tweezers to prevent wire breakage.
- ③ Do not apply excessive force to products mounted on boards to prevent core breakage.

8. Operating Environment

Do not use products in corrosive gases atmosphere such as chlorine gas, acid or sulfide gas.

9. Storage Requirements

- ① Storage Period

Products should be used within 12 months reckon from the date of our out-going inspection.

Solderability should be verified if this period is exceeded. (LQS33N/33C, LQP21A series should be used within 6 months.)
- ② Storage conditions
 - a) Store products in a warehouse in compliance with the following conditions :
 - Temperature : -10 to 40°C
 - Humidity : 30 to 70% (relative humidity)

Do not subject products to rapid changes in temperature and humidity.

Do not store them in corrosive gases atmosphere such as one containing sulfurous acid gas or alkaline gas.

This will prevent electrode oxidation which causes poor solderability and possible corrosion of coils.
 - b) Do not store products in bulk packaging to prevent collision among coils which causes core chipping and wire breakage.
 - c) Store products on pallets to protect from humidity, dust, etc.
 - d) Avoid heat shock, vibration, direct sunlight, etc.

10. Transportations

Do not apply excessive vibration or mechanical shock to products.

Dimensions of Taping

LQG21N/21C/21F, LQG3216F, LQG10A/11A/11N, LQH1N/1C, LQN1A/1H, LQN21A, LQH3N/3C, LQP10A/11A, LQW1608A (8mm Tape)

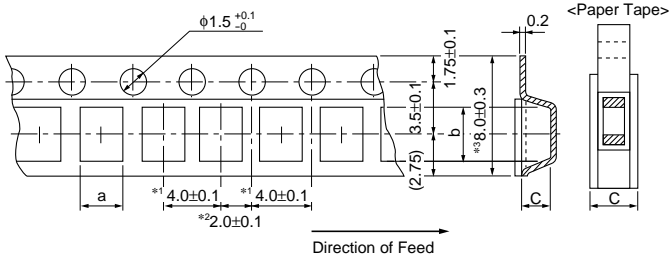

LQG10A/LQP10A/LQW1608A

- *1 : 2.0±0.05
- *2 : 1.0±0.05
- *3 : 8.0±0.2

● Paper Tape

Series	a	b	c	Minimum Quantity	
				φ180mm Reel	φ330mm Reel
LQG21NR10K10-2R2K10	1.45	2.25	1.1	4,000	10,000
LQG21C1R0N00-100N00					
LQG21F1R0N00-2R2N00					
LQG10A	0.62	1.12	1.0	10,000	50,000
LQG11A			1.1		
LQG11N	1.05	1.85	1.1	4,000	10,000
LQP10A	0.70	1.20	1.0	10,000	—
LQP11A	1.19	2.00	1.0	4,000	10,000
LQW1608A	1.10	1.00	1.1		

● Plastic Tape

Series	a	b	c	Minimum Quantity	
				φ180mm Reel	φ330mm Reel
LQG21N2R7K10-4R7K10	1.55	2.3	1.3	3,000	10,000
LQG21C220N00-470N00					
LQG21F4R7N00-470N00					
LQG3216F	1.9	3.5	2.0	2,000	7,500
LQH1N/1C · LQN1A/1H					
LQN21A	1.75	2.3	2.1	2,000	7,500
LQH3N/LQH3C	2.9	3.6	2.1		

(in mm)

LQS33N/33C, LQH(N)4N, LQH4C, LQN6C, LQS66C (12mm Tape)

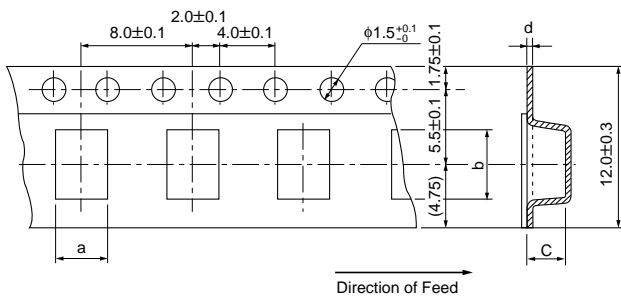

Series	a	b	c	d	Minimum Quantity	
					φ180mm Reel	φ330mm Reel
LQS33N/LQS33C	3.9	3.7	1.9	0.3	1,000	—
LQH(N)4N	3.6	4.9	2.7		500	2,500
LQH4C				—		
LQN6C	5.4	6.1	5.0	0.4	350	1,500
LQS66C	6.7	6.7	5.2			—

(in mm)

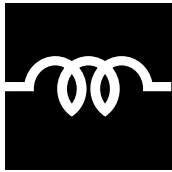

CHIP COIL

Design Kit



DESIGN KIT

Various chip coils are available in design kits assembled according to application.

<Design Kit for High Frequency Range>

Part Number : EKLB11EB

Contents : LQW1608A/LQN21A/LQN1H/
LQP10A/LQP11A



EKLB11EB

No.	Part Number	QTY. (pcs.)
1	LQW1608A3N9D00	20
2	LQW1608A4N7D00	20
3	LQW1608A5N6D00	20
4	LQW1608A6N8D00	20
5	LQW1608A8N2D00	20
6	LQW1608A10NJ00	20
7	LQW1608A12NJ00	20
8	LQW1608A15NJ00	20
9	LQW1608A18NJ00	20
10	LQW1608A22NJ00	20
11	LQW1608A27NJ00	20
12	LQW1608A33NJ00	20
13	LQW1608A39NJ00	20
14	LQW1608A47NJ00	20
15	LQW1608A56NJ00	20
16	LQW1608A68NJ00	20
17	LQW1608A82NJ00	20
18	LQW1608AR10J00	20
19	LQW1608AR12J00	20
20	LQW1608AR15J00	20
21	LQW1608AR18J00	20
22	LQW1608AR22J00	20
23	LQN21A3N3D04	20
24	LQN21A6N8D04	20
25	LQN21A8N2D04	20
26	LQN21A10NJ04	20
27	LQN21A12NJ04	20
28	LQN21A15NJ04	20
29	LQN21A18NJ04	20

No.	Part Number	QTY. (pcs.)
30	LQN21A22NJ04	20
31	LQN21A27NJ04	20
32	LQN21A33NJ04	20
33	LQN21A39NJ04	20
34	LQN21A47NJ04	20
35	LQN21A56NJ04	20
36	LQN21A68NJ04	20
37	LQN21A82NJ04	20
38	LQN21AR10J04	20
39	LQN21AR12J04	20
40	LQN21AR15J04	20
41	LQN21AR18J04	20
42	LQN21AR22J04	20
43	LQN1H54NK04	20
44	LQN1H95NK04	20
45	LQN1HR14K04	20
46	LQN1HR21K04	20
47	LQN1HR29K04	20
48	LQN1HR39K04	20
49	LQN1HR50K04	20
50	LQN1HR61K04	20
51	LQN1HR75K04	20
52	LQN1HR88K04	20
53	LQP10A1N0C00	20
54	LQP10A1N2C00	20
55	LQP10A1N5C00	20
56	LQP10A1N8C00	20
57	LQP10A2N2C00	20
58	LQP10A2N7C00	20
59	LQP10A3N3C00	20
60	LQP10A3N9C00	20
61	LQP10A4N7C00	20
62	LQP10A5N6C00	20
63	LQP10A6N8C00	20
64	LQP10A8N2C00	20
65	LQP10A10NG00	20
66	LQP10A12NG00	20
67	LQP10A15NG00	20
68	LQP10A18NG00	20
69	LQP10A22NG00	20
70	LQP10A27NG00	20
71	LQP10A33NG00	20
72	LQP11A1N3C00	20
73	LQP11A1N5C00	20
74	LQP11A1N8C00	20
75	LQP11A2N2C00	20
76	LQP11A2N7C00	20
77	LQP11A3N3C00	20
78	LQP11A3N9C00	20
79	LQP11A4N7C00	20
80	LQP11A5N6C00	20
81	LQP11A6N8C00	20
82	LQP11A8N2C00	20
83	LQP11A10NG00	20
84	LQP11A12NG00	20
85	LQP11A15NG00	20
86	LQP11A18NG00	20
87	LQP11A22NG00	20
88	LQP11A27NG00	20
89	LQP11A33NG00	20

●Please use the products in this Design Kit for experiment or test production, but do not use for mass production. When using for mass production, please order them after confirming detailed specifications by approving the appropriate individual specifications sheet.

<Design Kit for General Frequency Range>

Part Number : EKLB21EB

Contents : LQH3C/LQH3N/LQH4C/LQH4N/LQN4N

EKLB21EB

No.	Part Number	QTY. (pcs.)
1	LQH3C1R0M34	20
2	LQH3C2R2M34	20
3	LQH3C4R7M34	20
4	LQH3C100K34	20
5	LQH3C470K34	20
6	LQH3C221K34	20
7	LQH3C391K34	20
8	LQH3C561K34	20
9	LQH3NR10M34	20
10	LQH3NR18M34	20
11	LQH3NR27M34	20
12	LQH3NR39M34	20
13	LQH3NR56M34	20
14	LQH3NR68M34	20
15	LQH3NR82M34	20
16	LQH3N1R0M34	20
17	LQH3N1R5K34	20
18	LQH3N2R2K34	20
19	LQH3N3R3K34	20
20	LQH3N4R7K34	20
21	LQH3N6R8K34	20
22	LQH3N100K34	20
23	LQH3N120K34	20
24	LQH3N150K34	20
25	LQH3N220K34	20
26	LQH3N330K34	20
27	LQH3N470K34	20
28	LQH3N680K34	20
29	LQH3N101K34	20
30	LQH3N121K34	20
31	LQH3N181K34	20
32	LQH3N271K34	20
33	LQH3N391K34	20
34	LQH3N561K34	20
35	LQH4C1R0M04	20
36	LQH4C1R5M04	20
37	LQH4C2R2M04	20
38	LQH4C3R3M04	20
39	LQH4C4R7M04	20
40	LQH4C6R8M04	20
41	LQH4C100K04	20
42	LQH4C150K04	20
43	LQH4C220K04	20

No.	Part Number	QTY. (pcs.)
44	LQH4C330K04	20
45	LQH4C470K04	20
46	LQH4C680K04	20
47	LQH4C101K04	20
48	LQH4C151K04	20
49	LQH4C221K04	20
50	LQH4C331K04	20
51	LQH4C471K04	20
52	LQH4N180K04	20
53	LQH4N270K04	20
54	LQH4N390K04	20
55	LQH4N560K04	20
56	LQH4N820K04	20
57	LQH4N121K04	20
58	LQH4N221K04	20
59	LQH4N331K04	20
60	LQH4N471K04	20
61	LQH4N681K04	20
62	LQH4N821K04	20
63	LQH4N102K04	20
64	LQH4N122K04	20
65	LQH4N152K04	20
66	LQN4N182K04	20
67	LQN4N222K04	20

●Please use the products in this Design Kit for experiment or test production, but do not use for mass production. When using for mass production, please order them after confirming detailed specifications by approving the appropriate individual specification sheet.

<Design Kit for Individual Series>

Part Number	Contents
EKLM11UB	LQP11A
EKLM12UA	LQN21A
EKLM13UA	LQG11A
EKLM14UB	LQP10A
EKLM15UA	LQG10A
EKLM16UA	LQW1608A tight tolerance ($\pm 2\%$ 0.2nH)
EKLM17UA	LQW1608A tolerance ($\pm 5\%$ 0.5nH)
EKLM21UA	LQG21N/LQG21C

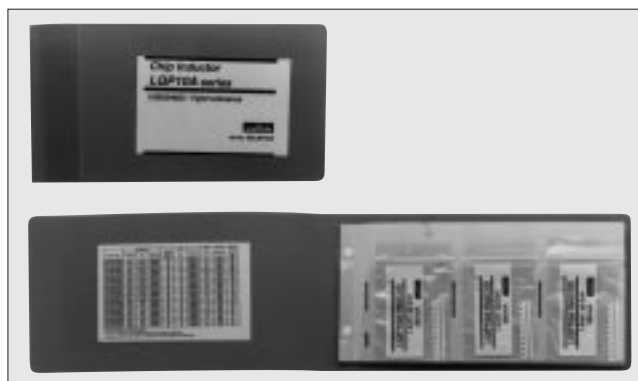

EKLM11UB

No.	Part Number	QTY. (pcs.)
1	LQP11A1N3C00	20
2	LQP11A1N5C00	20
3	LQP11A1N8C00	20
4	LQP11A2N2C00	20
5	LQP11A2N7C00	20
6	LQP11A3N3C00	20
7	LQP11A3N9C00	20
8	LQP11A4N7C00	20
9	LQP11A5N6C00	20
10	LQP11A6N8C00	20
11	LQP11A8N2C00	20
12	LQP11A10NG00	20
13	LQP11A12NG00	20
14	LQP11A15NG00	20
15	LQP11A18NG00	20
16	LQP11A22NG00	20
17	LQP11A27NG00	20
18	LQP11A33NG00	20
19	LQP11A39NG00	20
20	LQP11A47NG00	20
21	LQP11A56NG00	20
22	LQP11A68NG00	20
23	LQP11A82NG00	20
24	LQP11AR10G00	20

EKLM12UA

No.	Part Number	QTY. (pcs.)
1	LQN21A3N3D04	20
2	LQN21A6N8D04	20
3	LQN21A8N2D04	20
4	LQN21A10NJ04	20
5	LQN21A12NJ04	20
6	LQN21A15NJ04	20
7	LQN21A18NJ04	20
8	LQN21A22NJ04	20
9	LQN21A27NJ04	20
10	LQN21A33NJ04	20
11	LQN21A39NJ04	20
12	LQN21A47NJ04	20
13	LQN21A56NJ04	20
14	LQN21A68NJ04	20
15	LQN21A82NJ04	20
16	LQN21AR10J04	20
17	LQN21AR12J04	20
18	LQN21AR15J04	20
19	LQN21AR18J04	20
20	LQN21AR22J04	20

EKLM13UA

No.	Part Number	QTY. (pcs.)
1	LOG11A1N2S00	20
2	LOG11A1N5S00	20
3	LOG11A1N8S00	20
4	LOG11A2N2S00	20
5	LOG11A2N7S00	20
6	LOG11A3N3S00	20
7	LOG11A3N9S00	20
8	LOG11A4N7S00	20
9	LOG11A5N6S00	20
10	LOG11A6N8J00	20
11	LOG11A8N2J00	20
12	LOG11A10NJ00	20
13	LOG11A12NJ00	20
14	LOG11A15NJ00	20
15	LOG11A18NJ00	20
16	LOG11A22NJ00	20
17	LOG11A27NJ00	20
18	LOG11A33NJ00	20
19	LOG11A39NJ00	20
20	LOG11A47NJ00	20
21	LOG11A56NJ00	20
22	LOG11A68NJ00	20
23	LOG11A82NJ00	20
24	LOG11AR10J00	20

●Please use the products in this Design Kit for experiment or test production, but do not use for mass production. When using for mass production, please order them after confirming detailed specifications by approving the appropriate individual specification sheet.

EKLM14UB

No.	Part Number	QTY. (pcs.)
1	LQP10A1N0B00	20
2	LQP10A1N1B00	20
3	LQP10A1N2B00	20
4	LQP10A1N3B00	20
5	LQP10A1N5B00	20
6	LQP10A1N6B00	20
7	LQP10A1N8B00	20
8	LQP10A2N0B00	20
9	LQP10A2N2B00	20
10	LQP10A2N4B00	20
11	LQP10A2N7B00	20
12	LQP10A3N0B00	20
13	LQP10A3N3B00	20
14	LQP10A3N6B00	20
15	LQP10A3N9B00	20
16	LQP10A4N3B00	20
17	LQP10A4N7B00	20
18	LQP10A5N1B00	20
19	LQP10A5N6B00	20
20	LQP10A6N2B00	20
21	LQP10A6N8B00	20
22	LQP10A7N5B00	20
23	LQP10A8N2B00	20
24	LQP10A9N1B00	20
25	LQP10A10NG00	20
26	LQP10A12NG00	20
27	LQP10A15NG00	20
28	LQP10A18NG00	20
29	LQP10A22NG00	20
30	LQP10A27NG00	20
31	LQP10A33NG00	20

EKLM15UA

No.	Part Number	QTY. (pcs.)
1	LQG10A1N2S00	20
2	LQG10A1N5S00	20
3	LQG10A1N8S00	20
4	LQG10A2N2S00	20
5	LQG10A2N7S00	20
6	LQG10A3N3S00	20
7	LQG10A3N9S00	20
8	LQG10A4N7S00	20
9	LQG10A5N6S00	20
10	LQG10A6N8J00	20
11	LQG10A8N2J00	20
12	LQG10A10NJ00	20
13	LQG10A12NJ00	20
14	LQG10A15NJ00	20
15	LQG10A18NJ00	20
16	LQG10A22NJ00	20
17	LQG10A27NJ00	20
18	LQG10A33NJ00	20

EKLM16UA

No.	Part Number	QTY. (pcs.)
1	LQW1608A3N9C00	20
2	LQW1608A5N6C00	20
3	LQW1608A6N8C00	20
4	LQW1608A10NG00	20
5	LQW1608A12NG00	20
6	LQW1608A15NG00	20
7	LQW1608A18NG00	20
8	LQW1608A22NG00	20
9	LQW1608A27NG00	20
10	LQW1608A33NG00	20
11	LQW1608A39NG00	20
12	LQW1608A47NG00	20
13	LQW1608A56NG00	20
14	LQW1608A68NG00	20
15	LQW1608A82NG00	20
16	LQW1608AR10G00	20
17	LQW1608AR12G00	20
18	LQW1608AR15G00	20
19	LQW1608AR18G00	20
20	LQW1608AR22G00	20

EKLM17UA

No.	Part Number	QTY. (pcs.)
1	LQW1608A3N9D00	20
2	LQW1608A4N7D00	20
3	LQW1608A5N6D00	20
4	LQW1608A6N8D00	20
5	LQW1608A8N2D00	20
6	LQW1608A10NJ00	20
7	LQW1608A12NJ00	20
8	LQW1608A15NJ00	20
9	LQW1608A18NJ00	20
10	LQW1608A22NJ00	20
11	LQW1608A27NJ00	20
12	LQW1608A33NJ00	20
13	LQW1608A39NJ00	20
14	LQW1608A47NJ00	20
15	LQW1608A56NJ00	20
16	LQW1608A68NJ00	20
17	LQW1608A82NJ00	20
18	LQW1608AR10J00	20
19	LQW1608AR12J00	20
20	LQW1608AR15J00	20
21	LQW1608AR18J00	20
22	LQW1608AR22J00	20

EKLM21UA

No.	Part Number	QTY. (pcs.)
1	LOG21NR10K10	20
2	LOG21NR12K10	20
3	LOG21NR15K10	20
4	LOG21NR18K10	20
5	LOG21NR22K10	20
6	LOG21NR27K10	20
7	LOG21NR33K10	20
8	LOG21NR39K10	20
9	LOG21NR47K10	20
10	LOG21NR56K10	20
11	LOG21NR68K10	20
12	LOG21NR82K10	20
13	LOG21N1R0K10	20
14	LOG21N1R2K10	20
15	LOG21N1R5K10	20
16	LOG21N1R8K10	20
17	LOG21N2R2K10	20
18	LOG21N2R7K10	20
19	LOG21N3R3K10	20
20	LOG21N3R9K10	20
21	LOG21N4R7K10	20
22	LOG21C1R0N00	20
23	LOG21C2R2N00	20
24	LOG21C4R7N00	20
25	LOG21C100N00	20
26	LOG21C220N00	20
27	LOG21C470N00	20

●Please use the products in this Design Kit for experiment or test production, but do not use for mass production. When using for mass production, please order them after confirming detailed specifications by approving the appropriate individual specification sheet.

Information of Chip Coil

1. Land Area and Q-F Characteristics

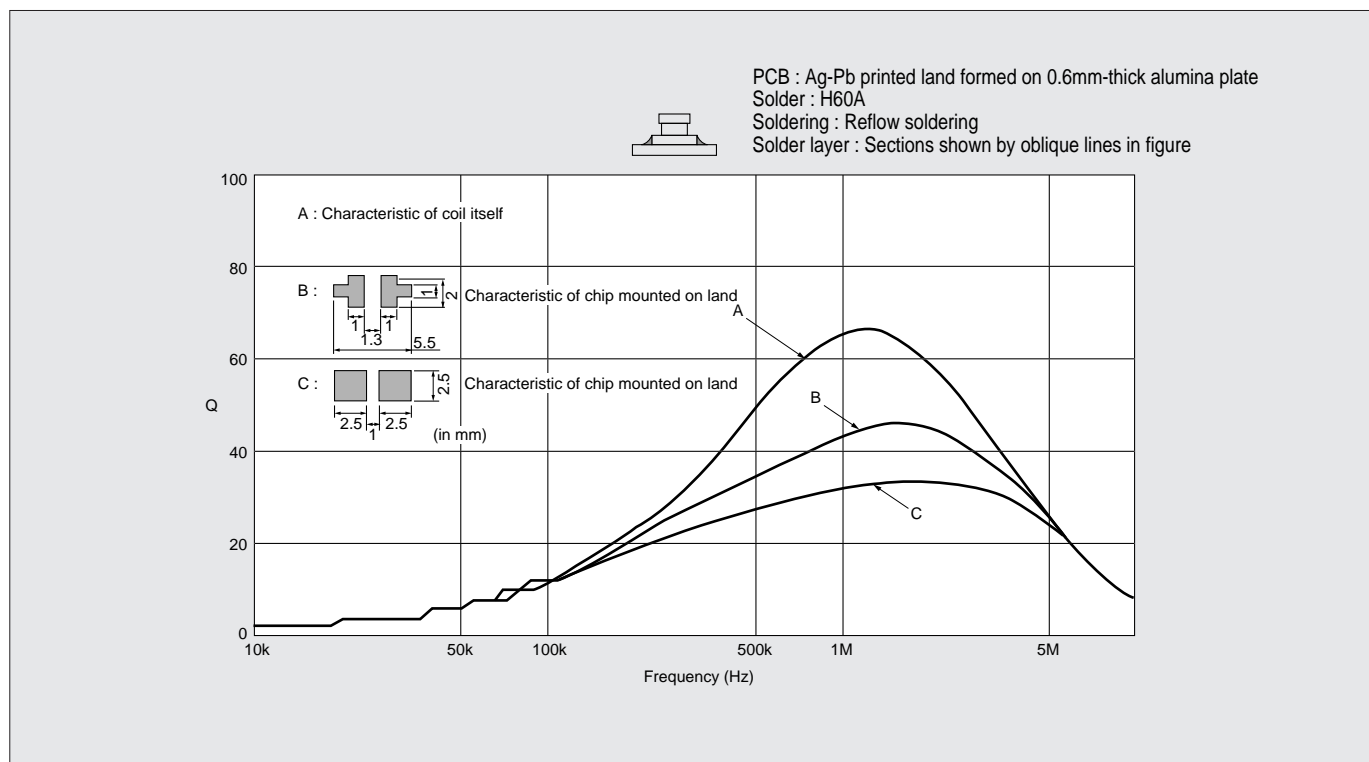

2. Coupling coefficient versus Coil-to-coil Spacing

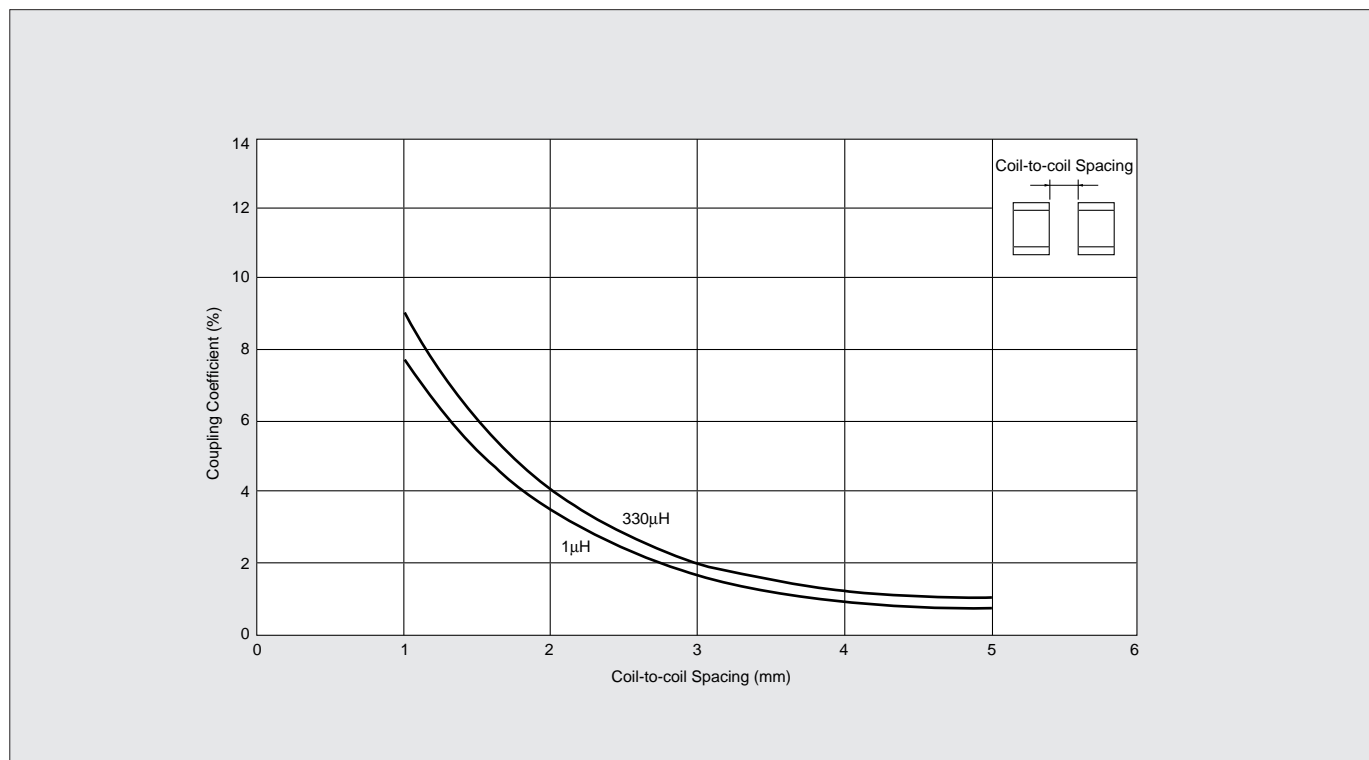

⚠ Note:**1. Export Control**

〈For customers outside Japan〉

Murata products should not be used or sold for use in the development, production, stockpiling or utilization of any conventional weapons or mass-destructive weapons (nuclear weapons, chemical or biological weapons, or missiles), or any other weapons.

〈For customers in Japan〉

For products which are controlled items subject to the "Foreign Exchange and Foreign Trade Law" of Japan, the export license specified by the law is required for export.

2. Please contact our sales representatives or product engineers before using our products listed in this catalog for the applications listed below which require especially high reliability for the prevention of defects which might directly cause damage to the third party's life, body or property, or when intending to use one of our products for other applications than specified in this catalog.

- ① Aircraft equipment
- ② Aerospace equipment
- ③ Undersea equipment
- ④ Power plant equipment
- ⑤ Medical equipment
- ⑥ Transportation equipment (vehicles, trains, ships, etc.)
- ⑦ Traffic signal equipment
- ⑧ Disaster prevention / crime prevention equipment
- ⑨ Data-processing equipment
- ⑩ Application of similar complexity and/or reliability requirements to the applications listed in the above

3. Product specifications in this catalog are as of February 2000. They are subject to change or our products in it may be discontinued without advance notice. Please check with our sales representatives or product engineers before your ordering. If there are any questions, please contact our sales representatives or product engineers.**4. The parts numbers and specifications listed in this catalog are for information only. You are requested to approve our product specification or to transact the approval sheet for product specification, before your ordering.****5. Please note that unless otherwise specified, we shall assume no responsibility whatsoever for any conflict or dispute that may occur in connection with the effect of our and/or third party's intellectual property rights and other related rights in consideration of your using our products and/or information described or contained in our catalogs. In this connection, no representation shall be made to the effect that any third parties are authorized to use the rights mentioned above under licenses without our consent.****6. None of ozone depleting substances (ODS) under the Montreal Protocol is used in manufacturing process of us.**