

FEATURES

- **High Accuracy:**
 - A Grade—0.05% Max
 - B Grade—0.1% Max
- **Low Drift:**
 - A Grade—10ppm/°C Max
 - B Grade—25ppm/°C Max
- **Low Profile (1mm) ThinSOT™ Package**
- Low Supply Current: 60μA Max
- Sinks and Sources Current
- Low Dropout Voltage
- Guaranteed Operational –40°C to 125°C
- Wide Supply Range to 18V
- Available Output Voltage Options: 1.25V, 2.048V, 2.5V, 3V, 3.3V, 4.096V and 5V

APPLICATIONS

- Handheld Instruments
- Negative Voltage References
- Industrial Control Systems
- Data Acquisition Systems
- Battery-Operated Equipment

DESCRIPTION

The LT[®]1790 is a family of SOT-23 micropower low dropout series references that combine high accuracy and low drift with low power dissipation and small package size. These micropower references use curvature compensation to obtain a low temperature coefficient and trimmed precision thin-film resistors to achieve high output accuracy. In addition, each LT1790 is post-package trimmed to greatly reduce the temperature coefficient and increase the output accuracy. Output accuracy is further assured by excellent line and load regulation. Special care has been taken to minimize thermally induced hysteresis.

The LT1790s are ideally suited for battery-operated systems because of their small size, low supply current and reduced dropout voltage. These references provide supply current and power dissipation advantages over shunt references that must idle the entire load current to operate. Since the LT1790 can also sink current, it can operate as a micropower negative voltage reference with the same performance as a positive reference.

LT, LTC and LT are registered trademarks of Linear Technology Corporation. ThinSOT is a trademark of Linear Technology Corporation.

TYPICAL APPLICATION

Positive Connection for LT1790-2.5

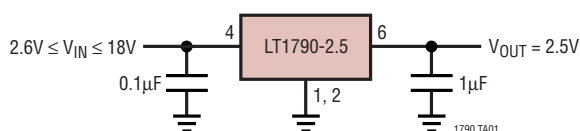

Typical V_{OUT} Distribution for LT1790-2.5

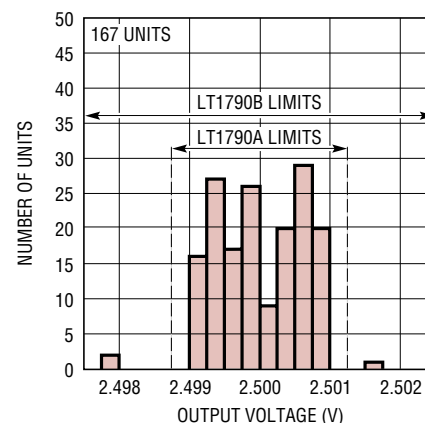

1790 TA02

LT1790

ABSOLUTE MAXIMUM RATINGS (Note 1)

Input Voltage	20V	Operating Temperature Range	
Specified Temperature Range		(Note 2)	-40°C to 125°C
Commercial	0°C to 70°C	Storage Temperature Range	
Industrial	-40°C to 85°C	(Note 3)	-65°C to 150°C
Output Short-Circuit Duration	Indefinite	Lead Temperature (Soldering, 10 sec)	300°C

PACKAGE/ORDER INFORMATION

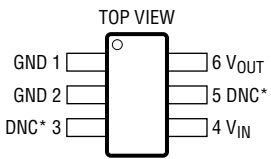
 <p>S6 PACKAGE 6-LEAD PLASTIC SOT-23 T_{JMAX} = 150°C, θ_{JA} = 230°C/W *DNC: DO NOT CONNECT</p>	ORDER PART NUMBER		OUTPUT VOLTAGE	S6 PART MARKING*
		LT1790ACS6-1.25	LT1790AIS6-1.25	1.250V
	LT1790BCS6-1.25	LT1790BIS6-1.25	2.048V	LTXU
	LT1790ACS6-2.048	LT1790AIS6-2.048	2.500V	LTPZ
	LT1790BCS6-2.048	LT1790BIS6-2.048	3.000V	LTQA
	LT1790ACS6-2.5	LT1790AIS6-2.5	3.300V	LTXW
	LT1790BCS6-2.5	LT1790BIS6-2.5	4.096V	LTQB
	LT1790ACS6-3	LT1790AIS6-3	5.000V	LTQC
	LT1790BCS6-3	LT1790BIS6-3		
	LT1790ACS6-3.3	LT1790AIS6-3.3		
	LT1790BCS6-3.3	LT1790BIS6-3.3		
	LT1790ACS6-4.096	LT1790AIS6-4.096		
	LT1790BCS6-4.096	LT1790BIS6-4.096		
	LT1790ACS6-5	LT1790AIS6-5		
	LT1790BCS6-5	LT1790BIS6-5		

* The temperature grades and parametric grades are identified by a label on the shipping container. Consult LTC Marketing for parts specified with wider operating temperature ranges.

AVAILABLE OPTIONS

OUTPUT VOLTAGE	INITIAL ACCURACY	TEMPERATURE COEFFICIENT	TEMPERATURE RANGE	
			0°C to 70°C	-40°C to 85°C
			ORDER PART NUMBER	ORDER PART NUMBER
1.250V	0.05% 0.1%	10ppm/°C 25ppm/°C	LT1790ACS6-1.25	LT1790AIS6-1.25
			LT1790BCS6-1.25	LT1790BIS6-1.25
2.048V	0.05% 0.1%	10ppm/°C 25ppm/°C	LT1790ACS6-2.048	LT1790AIS6-2.048
			LT1790BCS6-2.048	LT1790BIS6-2.048
2.500V	0.05% 0.1%	10ppm/°C 25ppm/°C	LT1790ACS6-2.5	LT1790AIS6-2.5
			LT1790BCS6-2.5	LT1790BIS6-2.5
3.000V	0.05% 0.1%	10ppm/°C 25ppm/°C	LT1790ACS6-3	LT1790AIS6-3
			LT1790BCS6-3	LT1790BIS6-3
3.300V	0.05% 0.1%	10ppm/°C 25ppm/°C	LT1790ACS6-3.3	LT1790AIS6-3.3
			LT1790BCS6-3.3	LT1790BIS6-3.3
4.096V	0.05% 0.1%	10ppm/°C 25ppm/°C	LT1790ACS6-4.096	LT1790AIS6-4.096
			LT1790BCS6-4.096	LT1790BIS6-4.096
5.000V	0.05% 0.1%	10ppm/°C 25ppm/°C	LT1790ACS6-5	LT1790AIS6-5
			LT1790BCS6-5	LT1790BIS6-5

1790fa

1.25V ELECTRICAL CHARACTERISTICS The ● denotes specifications that apply over the specified temperature range, otherwise specifications are at $T_A = 25^\circ\text{C}$. $C_L = 1\mu\text{F}$ and $V_{IN} = 2.6\text{V}$, unless otherwise noted.

PARAMETER	CONDITIONS		MIN	TYP	MAX	UNITS
Output Voltage (Notes 3, 4)	LT1790A		1.24937 -0.05	1.250	1.25062 0.05	V %
	LT1790B		1.24875 -0.10	1.250	1.25125 0.10	V %
	LT1790AC	● ●	1.24850 -0.120	1.250	1.25150 0.120	V %
	LT1790AI	● ●	1.24781 -0.175	1.250	1.25219 0.175	V %
	LT1790BC	● ●	1.24656 -0.275	1.250	1.25344 0.275	V %
	LT1790BI	● ●	1.24484 -0.4125	1.250	1.25516 0.4125	V %
Output Voltage Temperature Coefficient (Note 5)	$T_{MIN} \leq T_A \leq T_{MAX}$					
	LT1790A LT1790B	● ●		5 12	10 25	ppm/ $^\circ\text{C}$ ppm/ $^\circ\text{C}$
Line Regulation	$2.6\text{V} \leq V_{IN} \leq 18\text{V}$	●		50	170 220	ppm/V ppm/V
Load Regulation (Note 6)	I_{OUT} Source = 5mA, $V_{IN} = 2.8\text{V}$	●		100	160 250	ppm/mA ppm/mA
	I_{OUT} Sink = 1mA, $V_{IN} = 3.2\text{V}$	●		120	180 250	ppm/mA ppm/mA
Minimum Operating Voltage (Note 7)	V_{IN} , $\Delta V_{OUT} = 0.1\%$ $I_{OUT} = 0\text{mA}$	●		1.95	2.15	V
		●			2.50	V
	I_{OUT} Source = 5mA	●			2.90	V
	I_{OUT} Sink = 1mA	●			2.95	V
Supply Current	No Load	●		35	60 75	μA μA
Minimum Operating Current— Negative Output (See Figure 7)	$V_{OUT} = -1.25\text{V}, \pm 0.1\%$			100	125	μA
Turn-On Time	$C_{LOAD} = 1\mu\text{F}$			250		μs
Output Noise (Note 8)	$0.1\text{Hz} \leq f \leq 10\text{Hz}$ $10\text{Hz} \leq f \leq 1\text{kHz}$			10		μV_{P-P}
				14		μV_{RMS}
Long-Term Drift of Output Voltage (Note 9)				50		ppm/ $\sqrt{\text{kHr}}$
Hysteresis (Note 10)	$\Delta T = 0^\circ\text{C}$ to 70°C	●		40		ppm
	$\Delta T = -40^\circ\text{C}$ to 85°C	●		100		ppm

2.048V ELECTRICAL CHARACTERISTICS The ● denotes specifications that apply over the specified temperature range, otherwise specifications are at $T_A = 25^\circ\text{C}$. $C_L = 1\mu\text{F}$ and $V_{IN} = 2.8\text{V}$, unless otherwise noted.

PARAMETER	CONDITIONS		MIN	TYP	MAX	UNITS
Output Voltage (Notes 3, 4)	LT1790A		2.04697 -0.05	2.048	2.04902 0.05	V %
	LT1790B		2.04595 -0.10	2.048	2.05005 0.10	V %
	LT1790AC	● ●	2.04554 -0.120	2.048	2.05046 0.120	V %
	LT1790AI	● ●	2.04442 -0.175	2.048	2.05158 0.175	V %
	LT1790BC	● ●	2.04237 -0.275	2.048	2.05363 0.275	V %
	LT1790BI	● ●	2.03955 -0.4125	2.048	2.05645 0.4125	V %
Output Voltage Temperature Coefficient (Note 5)	$T_{MIN} \leq T_A \leq T_{MAX}$					
	LT1790A LT1790B	● ●		5 12	10 25	ppm/ $^\circ\text{C}$ ppm/ $^\circ\text{C}$
Line Regulation	$2.8\text{V} \leq V_{IN} \leq 18\text{V}$	●		50	170 220	ppm/V ppm/V
Load Regulation (Note 6)	I_{OUT} Source = 5mA	●		120	200 280	ppm/mA ppm/mA
	I_{OUT} Sink = 3mA	●		130	260 450	ppm/mA ppm/mA
Dropout Voltage (Note 7)	$V_{IN} - V_{OUT}$, $\Delta V_{OUT} = 0.1\%$ $I_{OUT} = 0\text{mA}$			50	100	mV
		●			500	mV
	I_{OUT} Source = 5mA	●			750	mV
	I_{OUT} Sink = 3mA	●			450	mV
Supply Current	No Load	●		35	60 75	μA μA
Minimum Operating Current— Negative Output (See Figure 7)	$V_{OUT} = -2.048\text{V}$, 0.1%			100	125	μA
Turn-On Time	$C_{LOAD} = 1\mu\text{F}$			350		μs
Output Noise (Note 8)	$0.1\text{Hz} \leq f \leq 10\text{Hz}$			22		μV_{P-P}
	$10\text{Hz} \leq f \leq 1\text{kHz}$			41		μV_{RMS}
Long-Term Drift of Output Voltage (Note 9)				50		ppm/ $\sqrt{\text{kHr}}$
Hysteresis (Note 10)	$\Delta T = 0^\circ\text{C}$ to 70°C	●		40		ppm
	$\Delta T = -40^\circ\text{C}$ to 85°C	●		100		ppm

2.5V ELECTRICAL CHARACTERISTICS The ● denotes specifications that apply over the specified temperature range, otherwise specifications are at $T_A = 25^\circ\text{C}$. $C_L = 1\mu\text{F}$ and $V_{IN} = 3\text{V}$, unless otherwise noted.

PARAMETER	CONDITIONS		MIN	TYP	MAX	UNITS
Output Voltage (Notes 3, 4)	LT1790A		2.49875 -0.05	2.5	2.50125 0.05	V %
	LT1790B		2.4975 -0.10	2.5	2.5025 0.10	V %
	LT1790AC	● ●	2.4970 -0.120	2.5	2.5030 0.120	V %
	LT1790AI	● ●	2.49563 -0.175	2.5	2.50438 0.175	V %
	LT1790BC	● ●	2.49313 -0.275	2.5	2.50688 0.275	V %
	LT1790BI	● ●	2.48969 -0.4125	2.5	2.51031 0.4125	V %
Output Voltage Temperature Coefficient (Note 5)	$T_{MIN} \leq T_A \leq T_{MAX}$					
	LT1790A LT1790B	● ●		5 12	10 25	ppm/ $^\circ\text{C}$ ppm/ $^\circ\text{C}$
Line Regulation	$3\text{V} \leq V_{IN} \leq 18\text{V}$	●		50	170 220	ppm/V ppm/V
Load Regulation (Note 6)	I_{OUT} Source = 5mA	●		80	160 250	ppm/mA ppm/mA
	I_{OUT} Sink = 3mA	●		70	110 300	ppm/mA ppm/mA
Dropout Voltage (Note 7)	$V_{IN} - V_{OUT}$, $\Delta V_{OUT} = 0.1\%$ $I_{OUT} = 0\text{mA}$			50	100 120	mV mV
	I_{OUT} Source = 5mA	●			450	mV
	I_{OUT} Sink = 3mA	●			250	mV
Supply Current	No Load	●		35	60 80	μA μA
Minimum Operating Current— Negative Output (See Figure 7)	$V_{OUT} = -2.5\text{V}$, 0.1%			100	125	μA
Turn-On Time	$C_{LOAD} = 1\mu\text{F}$			700		μs
Output Noise (Note 8)	$0.1\text{Hz} \leq f \leq 10\text{Hz}$			32		μV_{P-P}
	$10\text{Hz} \leq f \leq 1\text{kHz}$			48		μV_{RMS}
Long-Term Drift of Output Voltage (Note 9)				50		ppm/ $\sqrt{\text{kHr}}$
Hysteresis (Note 10)	$\Delta T = 0^\circ\text{C}$ to 70°C	●		40		ppm
	$\Delta T = -40^\circ\text{C}$ to 85°C	●		100		ppm

3V ELECTRICAL CHARACTERISTICS The ● denotes specifications that apply over the specified temperature range, otherwise specifications are at $T_A = 25^\circ\text{C}$. $C_L = 1\mu\text{F}$ and $V_{IN} = 3.5\text{V}$, unless otherwise noted.

PARAMETER	CONDITIONS	MIN	TYP	MAX	UNITS
Output Voltage (Notes 3, 4)	LT1790A	2.9985 -0.05	3	3.0015 0.05	V %
	LT1790B	2.9970 -0.10	3	3.003 0.10	V %
	LT1790AC	● ● 2.99640 -0.120	3	3.00360 0.120	V %
	LT1790AI	● ● 2.99475 -0.175	3	3.00525 0.175	V %
	LT1790BC	● ● 2.99175 -0.275	3	3.00825 0.275	V %
	LT1790BI	● ● 2.98763 -0.4125	3	3.01238 0.4125	V %
Output Voltage Temperature Coefficient (Note 5)	$T_{MIN} \leq T_A \leq T_{MAX}$				
	LT1790A LT1790B	● ●	5 12	10 25	ppm/ $^\circ\text{C}$ ppm/ $^\circ\text{C}$
Line Regulation	$3.5\text{V} \leq V_{IN} \leq 18\text{V}$		50	170 220	ppm/V ppm/V
Load Regulation (Note 6)	I_{OUT} Source = 5mA	●	80	160 250	ppm/mA ppm/mA
	I_{OUT} Sink = 3mA	●	70	110 300	ppm/mA ppm/mA
Dropout Voltage (Note 7)	$V_{IN} - V_{OUT}$, $\Delta V_{OUT} = 0.1\%$ $I_{OUT} = 0\text{mA}$		50	100 120	mV mV
	I_{OUT} Source = 5mA	●		450	mV
	I_{OUT} Sink = 3mA	●		250	mV
Supply Current	No Load	●	35	60 80	μA μA
Minimum Operating Current— Negative Output (See Figure 7)	$V_{OUT} = -3\text{V}$, 0.1%		100	125	μA
Turn-On Time	$C_{LOAD} = 1\mu\text{F}$		700		μs
Output Noise (Note 8)	$0.1\text{Hz} \leq f \leq 10\text{Hz}$		50		μV_{P-P}
	$10\text{Hz} \leq f \leq 1\text{kHz}$		56		μV_{RMS}
Long-Term Drift of Output Voltage (Note 9)			50		ppm/ $\sqrt{\text{kHr}}$
Hysteresis (Note 10)	$\Delta T = 0^\circ\text{C}$ to 70°C	●	40		ppm
	$\Delta T = -40^\circ\text{C}$ to 85°C	●	100		ppm

3.3V ELECTRICAL CHARACTERISTICS The ● denotes specifications that apply over the specified temperature range, otherwise specifications are at $T_A = 25^\circ\text{C}$. $C_L = 1\mu\text{F}$ and $V_{IN} = 3.8\text{V}$, unless otherwise noted.

PARAMETER	CONDITIONS		MIN	TYP	MAX	UNITS
Output Voltage (Notes 3, 4)	LT1790A		3.29835 -0.05	3.3	3.30165 0.05	V %
	LT1790B		3.2967 -0.10	3.3	3.3033 0.10	V %
	LT1790AC	● ●	3.29604 -0.120	3.3	3.30396 0.120	V %
	LT1790AI	● ●	3.29423 -0.175	3.3	3.30578 0.175	V %
	LT1790BC	● ●	3.29093 -0.275	3.3	3.30908 0.275	V %
	LT1790BI	● ●	3.28639 -0.4125	3.3	3.31361 0.4125	V %
Output Voltage Temperature Coefficient (Note 5)	$T_{MIN} \leq T_A \leq T_{MAX}$					
	LT1790A LT1790B	● ●		5 12	10 25	ppm/°C ppm/°C
Line Regulation	$3.8\text{V} \leq V_{IN} \leq 18\text{V}$	●		50	170 220	ppm/V ppm/V
Load Regulation (Note 6)	I_{OUT} Source = 5mA	●		80	160 250	ppm/mA ppm/mA
	I_{OUT} Sink = 3mA	●		70	110 300	ppm/mA ppm/mA
Dropout Voltage (Note 7)	$V_{IN} - V_{OUT}$, $\Delta V_{OUT} = 0.1\%$ $I_{OUT} = 0\text{mA}$			50	100	mV
		●			120	mV
	I_{OUT} Source = 5mA	●			450	mV
	I_{OUT} Sink = 3mA	●			250	mV
Supply Current	No Load	●		35	60 80	μA μA
Minimum Operating Current— Negative Output (See Figure 7)	$V_{OUT} = -3.3\text{V}$, 0.1%			100	125	μA
Turn-On Time	$C_{LOAD} = 1\mu\text{F}$			700		μs
Output Noise (Note 8)	$0.1\text{Hz} \leq f \leq 10\text{Hz}$			50		μV_{P-P}
	$10\text{Hz} \leq f \leq 1\text{kHz}$			67		μV_{RMS}
Long-Term Drift of Output Voltage (Note 9)				50		ppm/ $\sqrt{\text{kHr}}$
Hysteresis (Note 10)	$\Delta T = 0^\circ\text{C}$ to 70°C	●		40		ppm
	$\Delta T = -40^\circ\text{C}$ to 85°C	●		100		ppm

4.096V ELECTRICAL CHARACTERISTICS The ● denotes specifications that apply over the specified temperature range, otherwise specifications are at $T_A = 25^\circ\text{C}$. $C_L = 1\mu\text{F}$ and $V_{IN} = 4.6\text{V}$, unless otherwise noted.

PARAMETER	CONDITIONS	MIN	TYP	MAX	UNITS
Output Voltage (Notes 3, 4)	LT1790A	4.094 -0.05	4.096	4.098 0.05	V %
	LT1790B	4.092 -0.10	4.096	4.10 0.10	V %
	LT1790AC	● ● 4.09108 -0.120	4.096	4.10092 0.120	V %
	LT1790AI	● ● 4.08883 -0.175	4.096	4.10317 0.175	V %
	LT1790BC	● ● 4.08474 -0.275	4.096	4.10726 0.275	V %
	LT1790BI	● ● 4.07910 -0.4125	4.096	4.11290 0.4125	V %
Output Voltage Temperature Coefficient (Note 5)	$T_{MIN} \leq T_A \leq T_{MAX}$				
	LT1790A LT1790B	● ●	5 12	10 25	ppm/ $^\circ\text{C}$ ppm/ $^\circ\text{C}$
Line Regulation	$4.6\text{V} \leq V_{IN} \leq 18\text{V}$		50	170 220	ppm/V ppm/V
Load Regulation (Note 6)	I_{OUT} Source = 5mA		80	160 250	ppm/mA ppm/mA
	I_{OUT} Sink = 3mA	●	70	110 300	ppm/mA ppm/mA
Dropout Voltage (Note 7)	$V_{IN} - V_{OUT}$, $\Delta V_{OUT} = 0.1\%$ $I_{OUT} = 0\text{mA}$		50	100	mV
	I_{OUT} Source = 5mA	●		120	mV
	I_{OUT} Sink = 3mA	●		450	mV
		●		250	mV
Supply Current	No Load		35	60 80	μA μA
Minimum Operating Current— Negative Output (See Figure 7)	$V_{OUT} = -4.096\text{V}$, 0.1%		100	125	μA
Turn-On Time	$C_{LOAD} = 1\mu\text{F}$		700		μs
Output Noise (Note 8)	$0.1\text{Hz} \leq f \leq 10\text{Hz}$		60		μV_{P-P}
	$10\text{Hz} \leq f \leq 1\text{kHz}$		89		μV_{RMS}
Long-Term Drift of Output Voltage (Note 9)			50		ppm/ $\sqrt{\text{kHr}}$
Hysteresis (Note 10)	$\Delta T = 0^\circ\text{C}$ to 70°C	●	40		ppm
	$\Delta T = -40^\circ\text{C}$ to 85°C	●	100		ppm

5V ELECTRICAL CHARACTERISTICS The ● denotes specifications that apply over the specified temperature range, otherwise specifications are at $T_A = 25^\circ\text{C}$. $C_L = 1\mu\text{F}$ and $V_{IN} = 5.5\text{V}$, unless otherwise noted.

PARAMETER	CONDITIONS	MIN	TYP	MAX	UNITS
Output Voltage (Notes 3, 4)	LT1790A	4.9975 -0.05	5	5.0025 0.05	V %
	LT1790B	4.995 -0.10	5	5.005 0.10	V %
	LT1790AC	● ● 4.99400 -0.120	5	5.00600 0.120	V %
	LT1790AI	● ● 4.99125 -0.175	5	5.00875 0.175	V %
	LT1790BC	● ● 4.98625 -0.275	5	5.01375 0.275	V %
	LT1790BI	● ● 4.97938 -0.4125	5	5.02063 0.4125	V %
Output Voltage Temperature Coefficient (Note 5)	$T_{MIN} \leq T_A \leq T_{MAX}$ LT1790A	●	5	10	ppm/ $^\circ\text{C}$
	LT1790B	●	12	25	ppm/ $^\circ\text{C}$
Line Regulation	$5.5\text{V} \leq V_{IN} \leq 18\text{V}$	●	50	170 220	ppm/V ppm/V
Load Regulation (Note 6)	I_{OUT} Source = 5mA	●	80	160 250	ppm/mA ppm/mA
	I_{OUT} Sink = 3mA	●	70	110 300	ppm/mA ppm/mA
Dropout Voltage (Note 7)	$V_{IN} - V_{OUT}$, $\Delta V_{OUT} = 0.1\%$ $I_{OUT} = 0\text{mA}$	●	50	100 120	mV mV
	I_{OUT} Source = 5mA	●		450	mV
	I_{OUT} Sink = 3mA	●		250	mV
Supply Current	No Load	●	35	60 80	μA μA
Minimum Operating Current— Negative Output (See Figure 7)	$V_{OUT} = -5\text{V}$, 0.1%		100	125	μA
Turn-On Time	$C_{LOAD} = 1\mu\text{F}$		700		μs
Output Noise (Note 8)	$0.1\text{Hz} \leq f \leq 10\text{Hz}$		80		μV_{P-P}
	$10\text{Hz} \leq f \leq 1\text{kHz}$		118		μV_{RMS}
Long-Term Drift of Output Voltage (Note 9)			50		ppm/ $\sqrt{\text{kHr}}$
Hysteresis (Note 10)	$\Delta T = 0^\circ\text{C}$ to 70°C	●	40		ppm
	$\Delta T = -40^\circ\text{C}$ to 85°C	●	100		ppm

Note 1: Absolute Maximum Ratings are those values beyond which the life of the device may be impaired.

Note 2: The LT1790 is guaranteed functional over the operating temperature range of -40°C to 125°C . The LT1790-1.25 at 125°C is typically less than 2% above the nominal voltage. The other voltage options are typically less than 0.25% above their nominal voltage.

Note 3: If the part is stored outside of the specified temperature range, the output voltage may shift due to hysteresis.

Note 4: ESD (Electrostatic Discharge) sensitive device. Extensive use of ESD protection devices are used internal to the LT1790, however, high electrostatic discharge can damage or degrade the device. Use proper ESD handling precautions.

Note 5: Temperature coefficient is measured by dividing the change in output voltage by the specified temperature range. Incremental slope is also measured at 25°C .

Note 6: Load regulation is measured on a pulse basis from no load to the specified load current. Output changes due to die temperature change must be taken into account separately.

Note 7: Excludes load regulation errors.

Note 8: Peak-to-peak noise is measured with a single pole highpass filter at 0.1Hz and a 2-pole lowpass filter at 10Hz. The unit is enclosed in a still air environment to eliminate thermocouple effects on the leads. The test time is 10 seconds. Integrated RMS noise is measured from 10Hz to 1kHz with the HP3561A analyzer.

ELECTRICAL CHARACTERISTICS

Note 9: Long-term drift typically has a logarithmic characteristic and therefore changes after 1000 hours tend to be smaller than before that time. Long-term drift is affected by differential stress between the IC and the board material created during board assembly. See Applications Information.

Note 10: Hysteresis in the output voltage is created by package stress that differs depending on whether the IC was previously at a higher or lower temperature. Output voltage is always measured at 25°C, but the IC is cycled to 85°C or -40°C before a successive measurements. Hysteresis is roughly proportional to the square of the temperature change. Hysteresis is not a problem for operational temperature excursions where the instrument might be stored at high or low temperature. See Applications Information.

1.25V TYPICAL PERFORMANCE CHARACTERISTICS

Each of the voltage options have similar performance curves. For the 3V, 3.3V and the 4.096V options, the curves can be estimated based on the 2.5V and 5V curves.

Output Voltage Temperature Drift

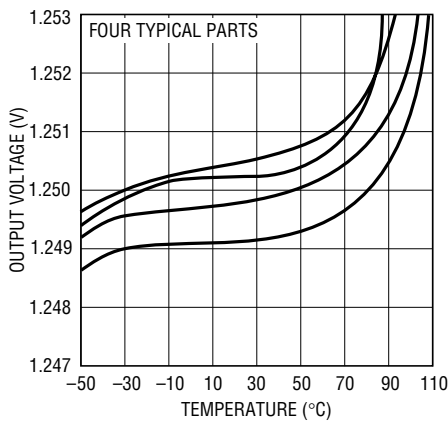

Minimum Input-Output Voltage Differential (Sourcing)

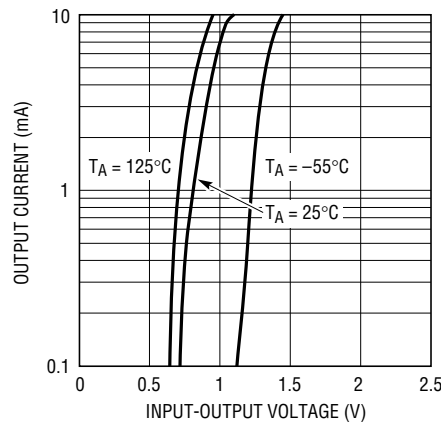

Minimum Input-Output Voltage Differential (Sinking)

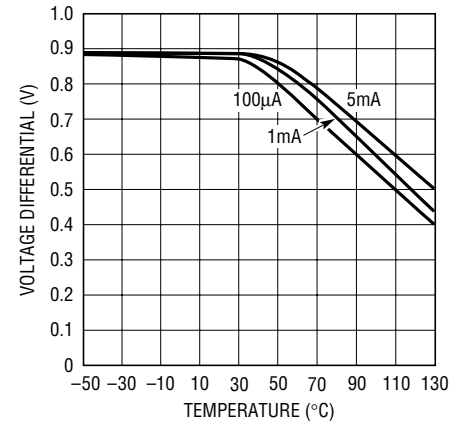

Load Regulation (Sourcing)

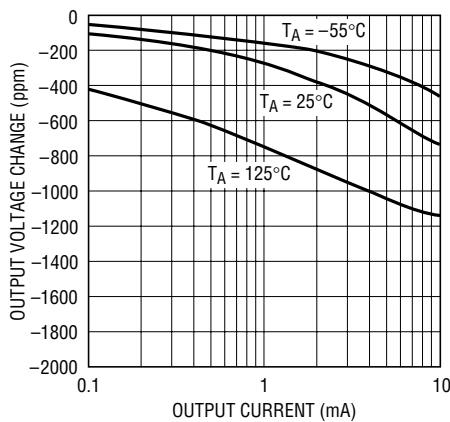

Load Regulation (Sinking)

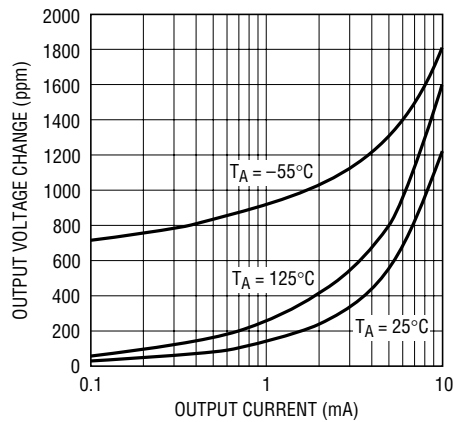

Supply Current vs Input Voltage

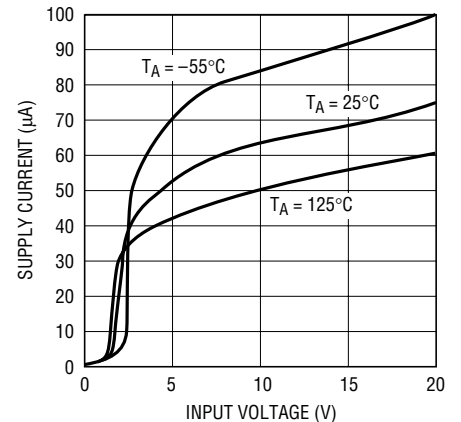

1.25V TYPICAL PERFORMANCE CHARACTERISTICS

Each of the voltage options have similar performance curves. For the 3V, 3.3V and the 4.096V options, the curves can be estimated based on the 2.5V and 5V curves.

Line Regulation

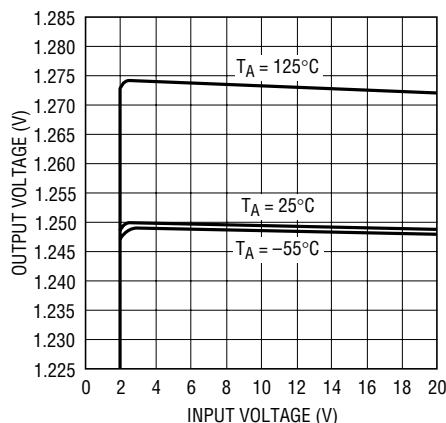

17901.25 G07

Power Supply Rejection Ratio vs Frequency

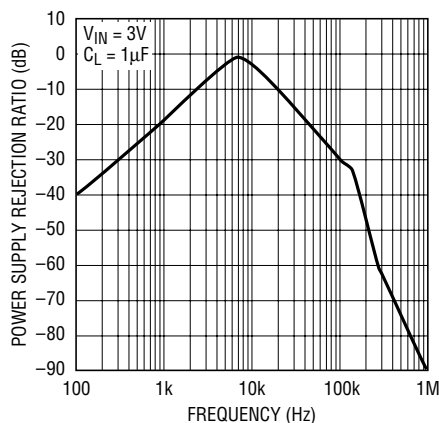

17901.25 G08

Output Impedance vs Frequency

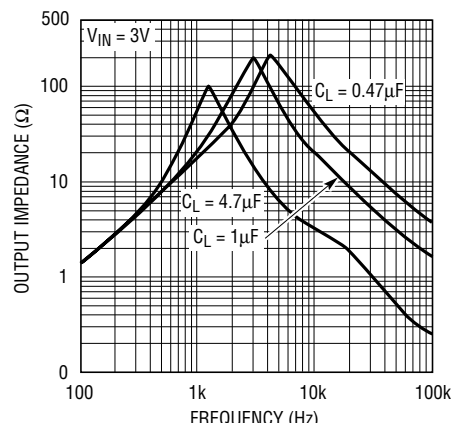

17901.25 G09

-1.25V Characteristics

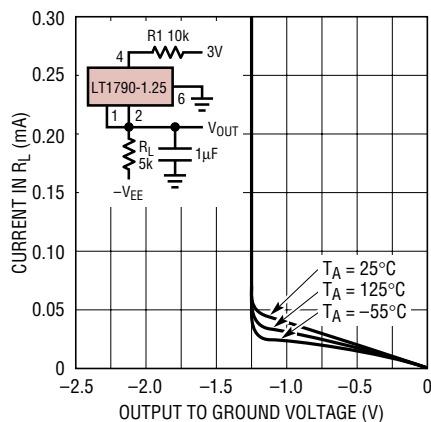

17091.25 G10

Long-Term Drift (Data Points Reduced After 500 Hr)

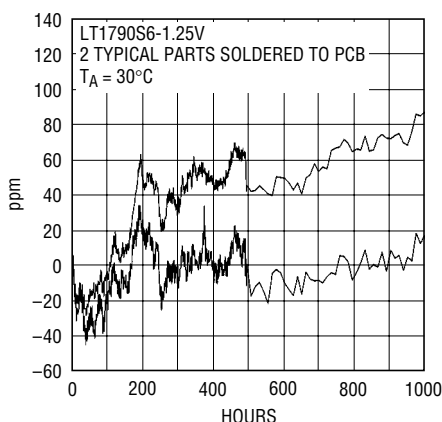

17901.25 G10

Output Noise 0.1Hz to 10Hz

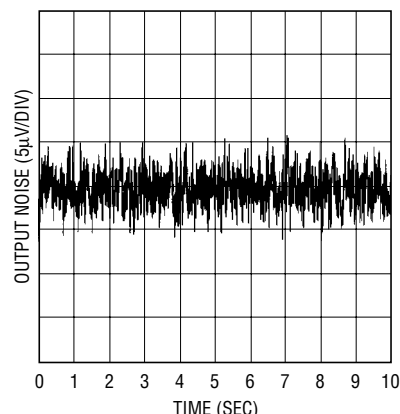

17901.2 G12

Output Voltage Noise Spectrum

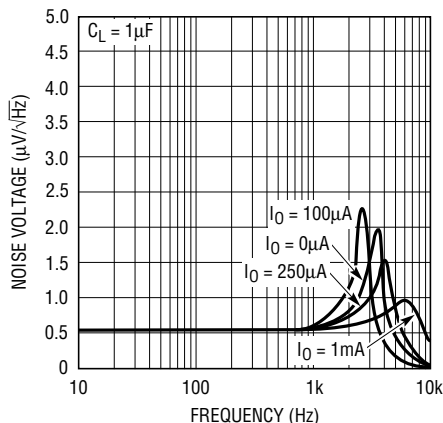

17901.25 G13

Integrated Noise 10Hz to 1kHz

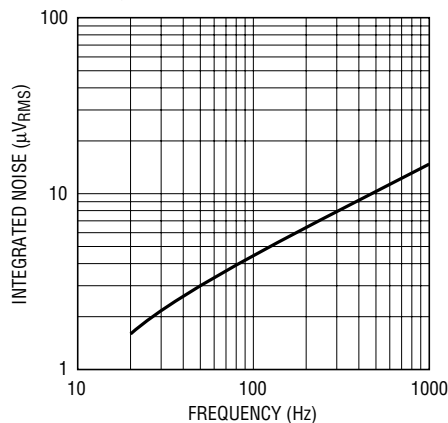

LT1790 G01

2.048V TYPICAL PERFORMANCE CHARACTERISTICS

Each of the voltage options have similar performance curves. For the 3V, 3.3V and the 4.096V options, the curves can be estimated based on the 2.5V and 5V curves.

Output Voltage Temperature Drift

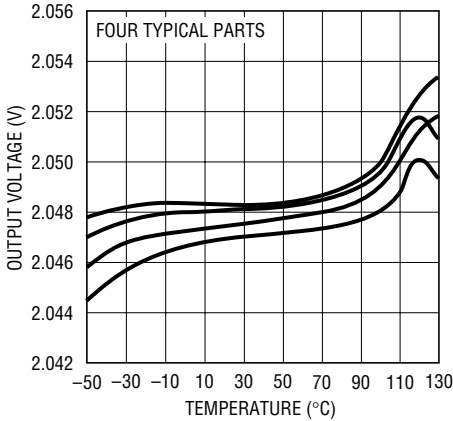

17902.048 G01

Minimum Input-Output Voltage Differential (Sourcing)

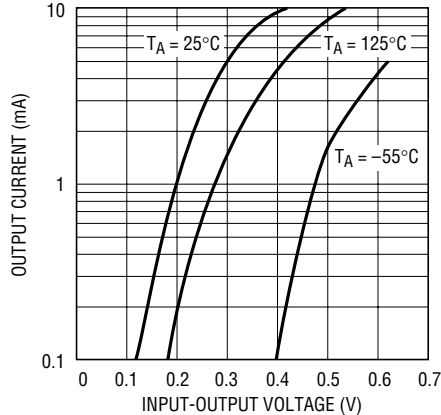

17902.048 G02

Minimum Input-Output Voltage Differential (Sinking)

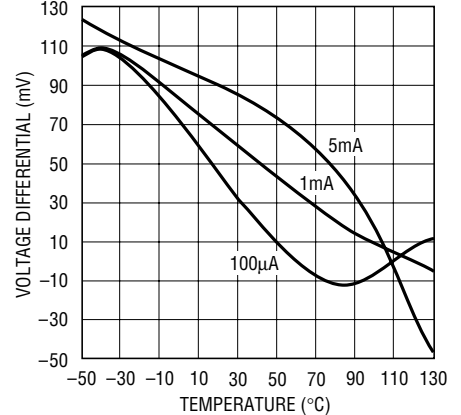

17902.048 G03

Load Regulation (Sourcing)

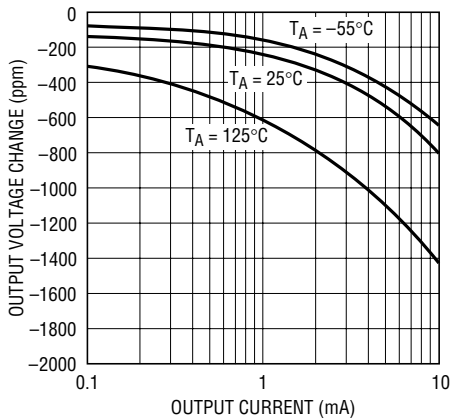

17902.048 G04

Load Regulation (Sinking)

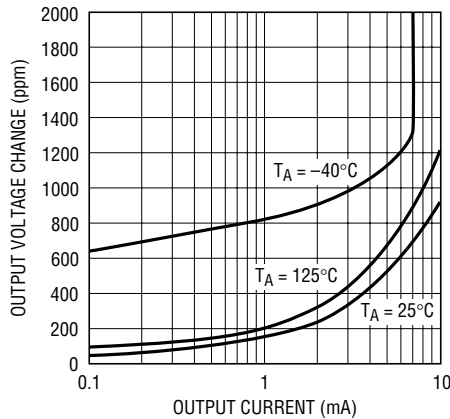

17902.048 G05

Supply Current vs Input Voltage

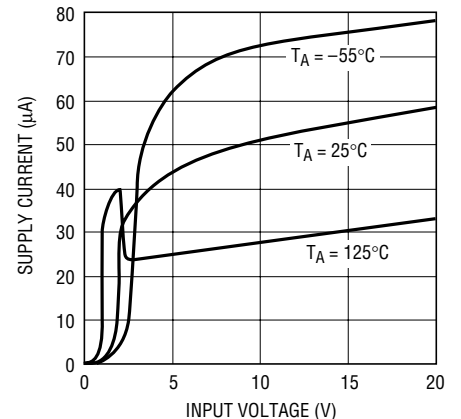

17902.048 G06

Line Regulation

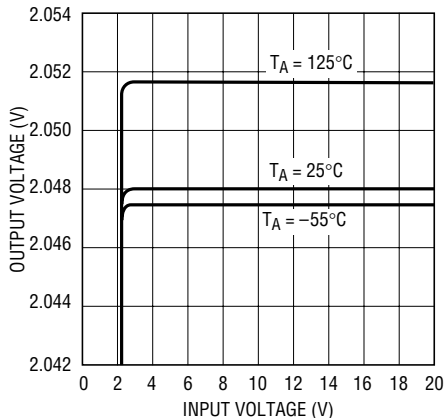

17902.048 G07

Power Supply Rejection Ratio vs Frequency

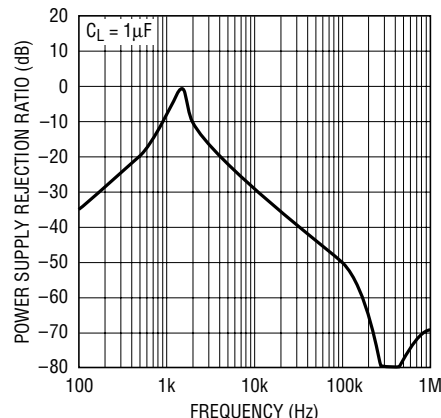

17902.048 G08

Output Impedance vs Frequency

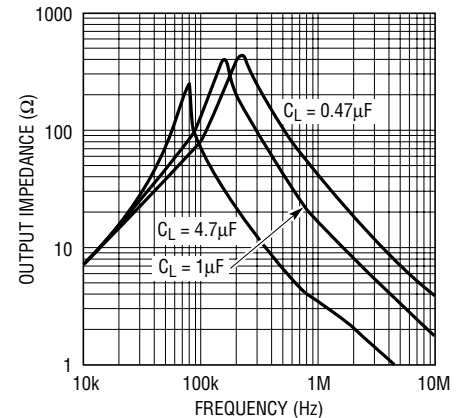

17902.048 G09

2.048V TYPICAL PERFORMANCE CHARACTERISTICS

Each of the voltage options have similar performance curves. For the 3V, 3.3V and the 4.096V options, the curves can be estimated based on the 2.5V and 5V curves.

-2.048V Characteristics

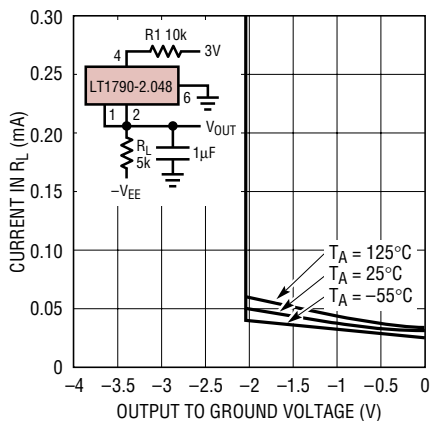

17902.048 G10

Long-Term Drift

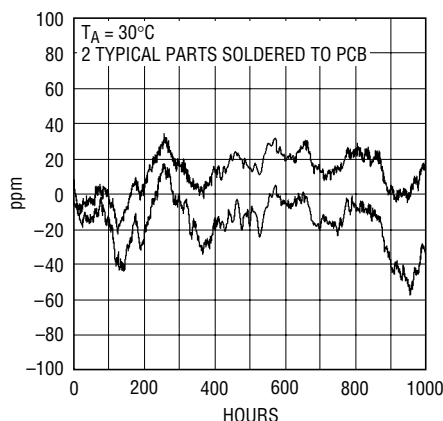

17901.048 G11

Output Noise 0.1Hz to 10Hz

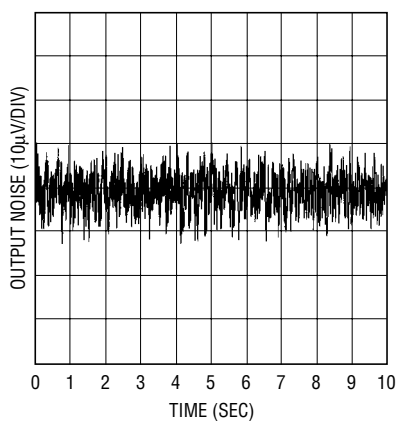

17902.048 G12

Output Voltage Noise Spectrum

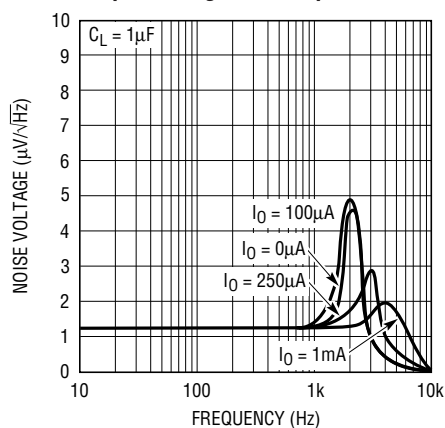

17902.048 G13

Integrated Noise 10Hz to 1kHz

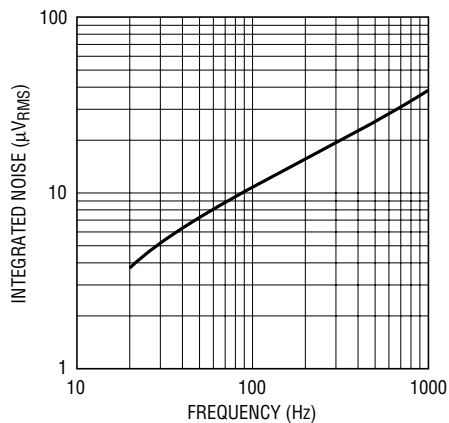

LT1790 G02

2.5V TYPICAL PERFORMANCE CHARACTERISTICS

Each of the voltage options have similar performance curves. For the 3V, 3.3V and the 4.096V options, the curves can be estimated based on the 2.5V and 5V curves.

Output Voltage Temperature Drift

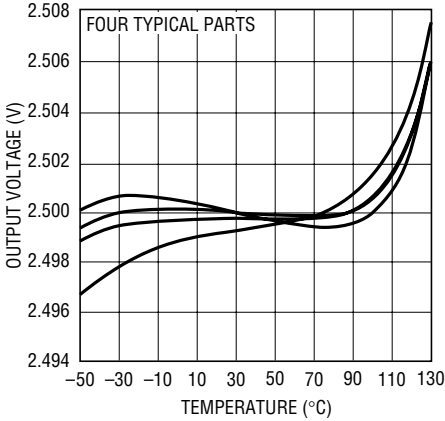

Minimum Input-Output Voltage Differential (Sourcing)

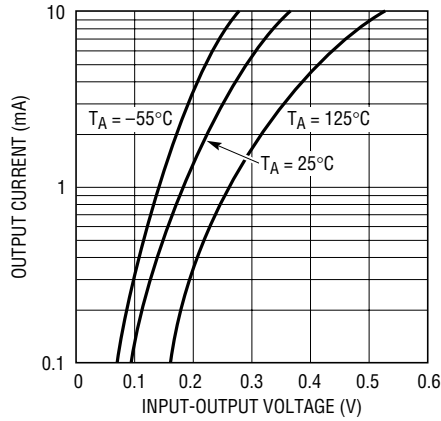

Minimum Input-Output Voltage Differential (Sinking)

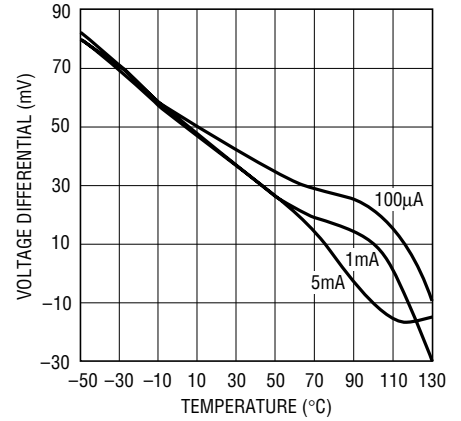

Load Regulation (Sourcing)

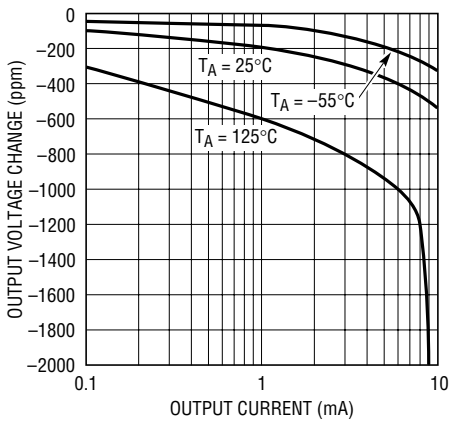

Load Regulation (Sinking)

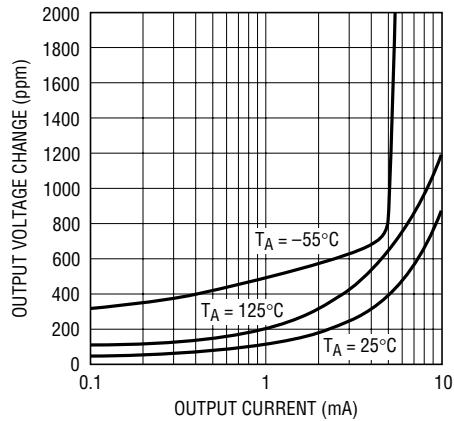

Supply Current vs Input Voltage

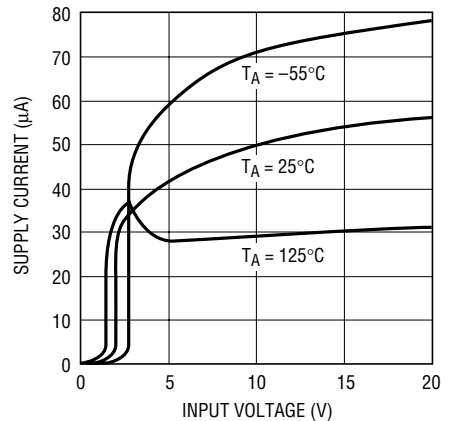

Line Regulation

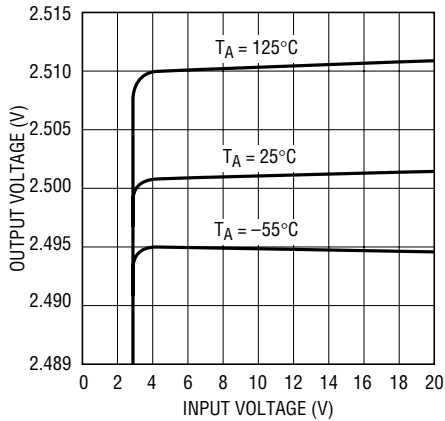

Power Supply Rejection Ratio vs Frequency

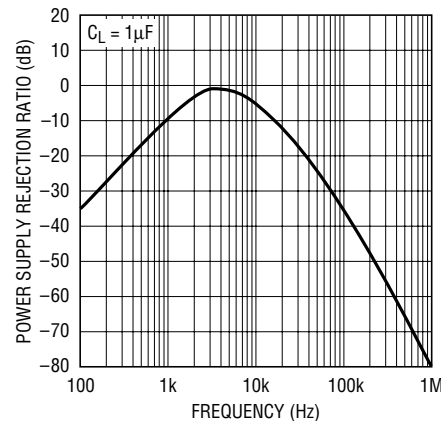

Output Impedance vs Frequency

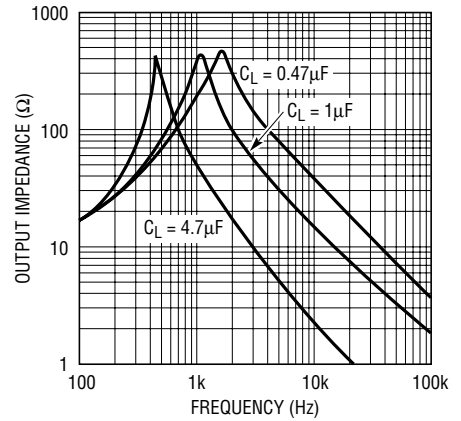

2.5V TYPICAL PERFORMANCE CHARACTERISTICS

Each of the voltage options have similar performance curves. For the 3V, 3.3V and the 4.096V options, the curves can be estimated based on the 2.5V and 5V curves.

-2.5V Characteristics

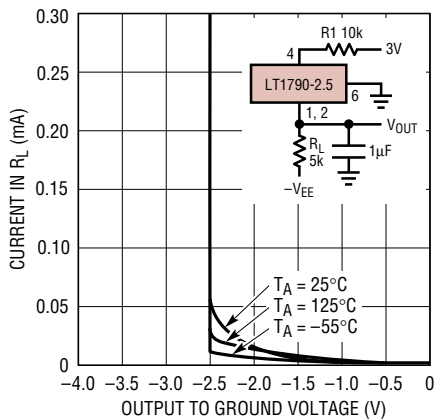

17902.5 G10

Long-Term Drift
(Data Points Reduced After 500 Hr)

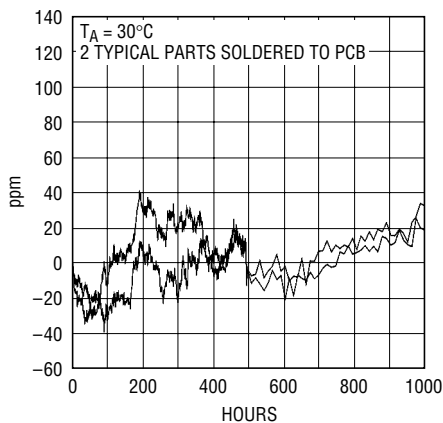

17902.5 G11

Output Noise 0.1Hz to 10Hz

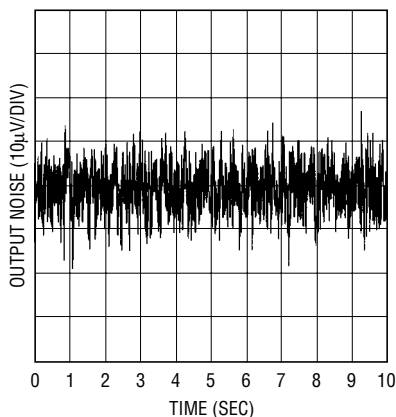

17901.5 G12

Output Voltage Noise Spectrum

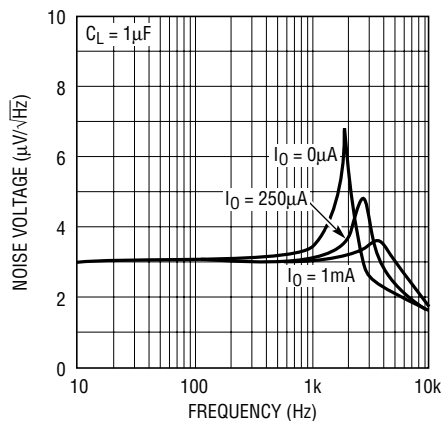

1790 G05

Integrated Noise 10Hz to 1kHz

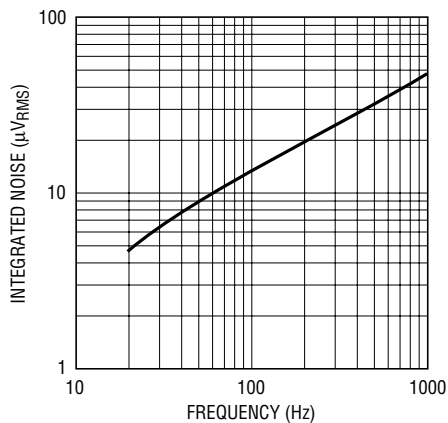

LT1790 G03

5V TYPICAL PERFORMANCE CHARACTERISTICS

Each of the voltage options have similar performance curves. For the 3V, 3.3V and the 4.096V options, the curves can be estimated based on the 2.5V and 5V curves.

Output Voltage Temperature Drift

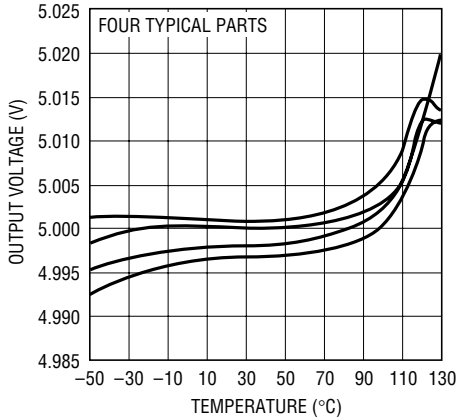

17905 G01

Minimum Input-Output Voltage Differential (Sourcing)

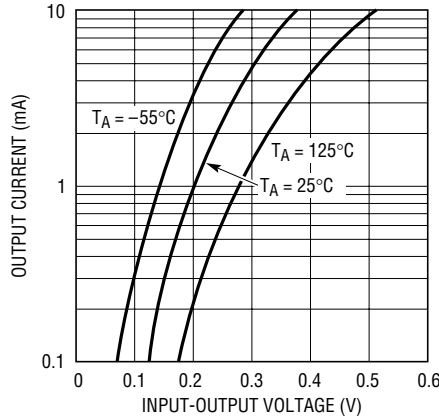

17905 G02

Minimum Input-Output Voltage Differential (Sinking)

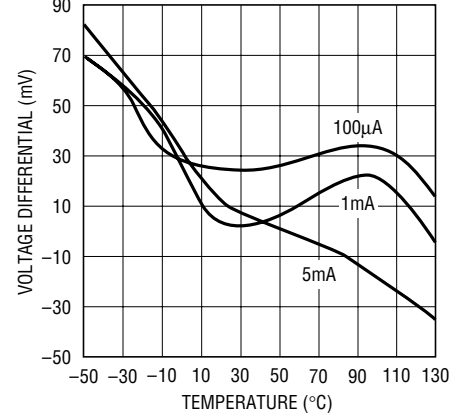

17905 G03

Load Regulation (Sourcing)

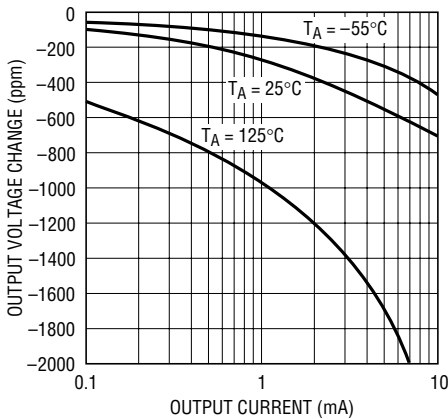

17905 G04

Load Regulation (Sinking)

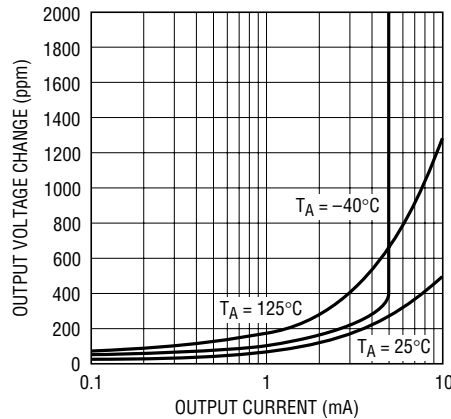

17905 G05

Supply Current vs Input Voltage

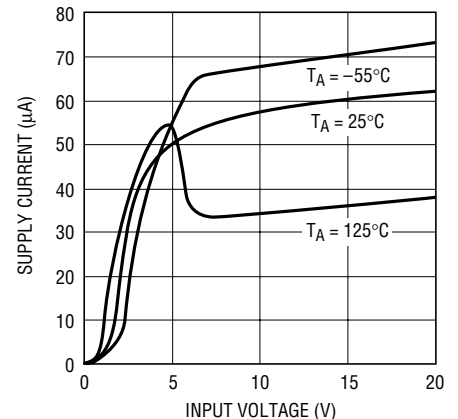

17905 G06

Line Regulation

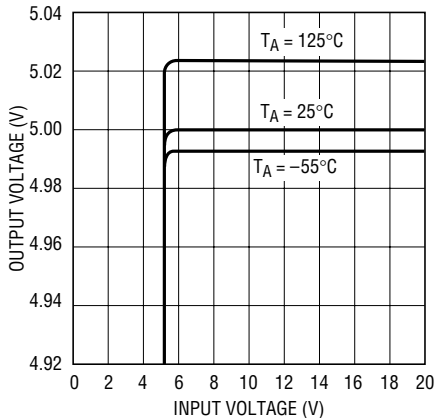

17905 G07

Power Supply Rejection Ratio vs Frequency

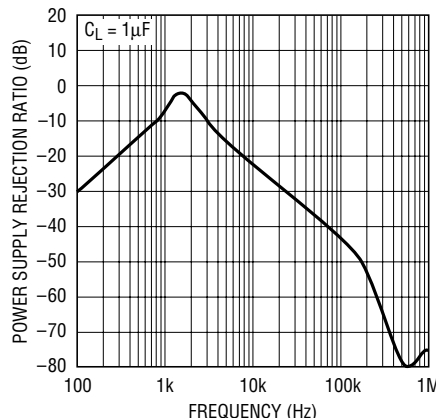

17905 G08

Output Impedance vs Frequency

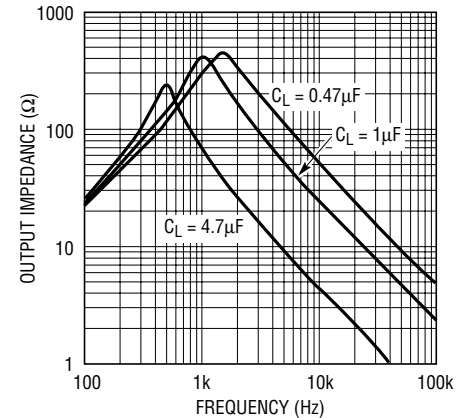

17905 G09

1790fa

5V TYPICAL PERFORMANCE CHARACTERISTICS

Each of the voltage options have similar performance curves. For the 3V, 3.3V and the 4.096V options, the curves can be estimated based on the 2.5V and 5V curves.

-5V Characteristics

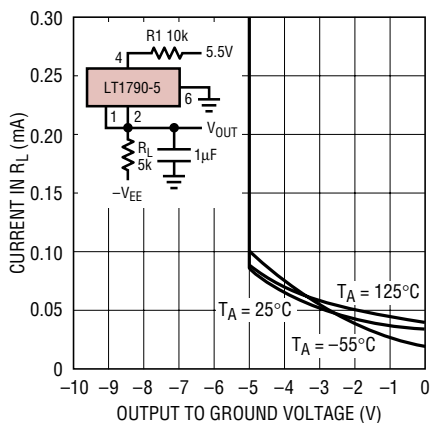

Long-Term Drift

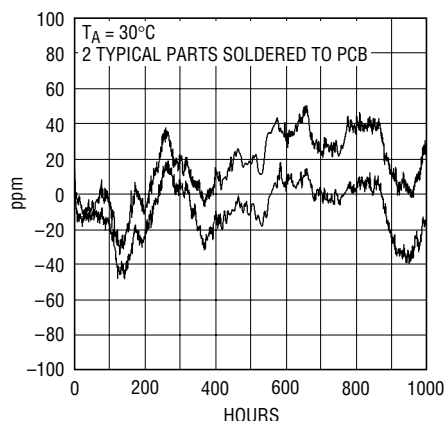

Output Noise 0.1Hz to 10Hz

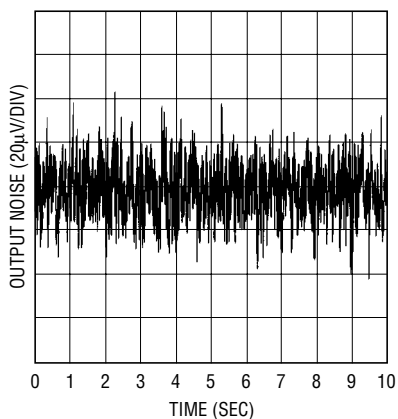

Output Voltage Noise Spectrum

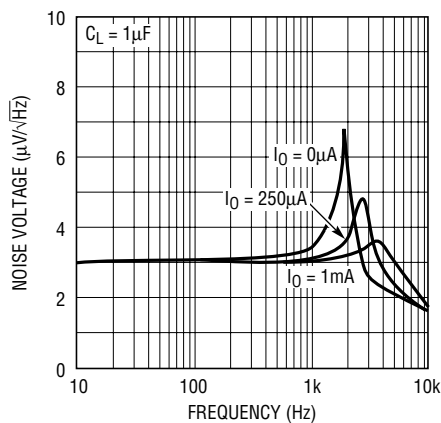

Integrated Noise 10Hz to 1kHz

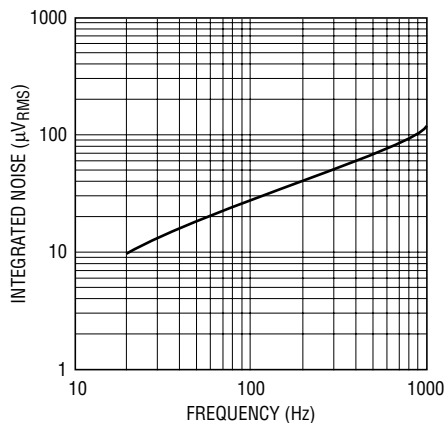

APPLICATIONS INFORMATION

Bypass and Load Capacitors

The LT1790 voltage references should have an input bypass capacitor of $0.1\mu\text{F}$ or larger, however the bypassing of other local devices may serve as the required component. These references also require an output capacitor for stability. The optimum output capacitance for most applications is $1\mu\text{F}$, although larger values work as well. This capacitor affects the turn-on and settling time for the output to reach its final value.

All LT1790 voltages perform virtually the same, so the LT1790-2.5 is used as an example.

Figure 1 shows the turn-on time for the LT1790-2.5 with a $1\mu\text{F}$ input bypass and $1\mu\text{F}$ load capacitor. Figure 2 shows the output response to a 0.5V transient on V_{IN} with the same capacitors.

The test circuit of Figure 3 is used to measure the stability of various load currents. With $R_{\text{L}} = 1\text{k}$, the 1V step produces a current step of 1mA . Figure 4 shows the response to a $\pm 0.5\text{mA}$ load. Figure 5 is the output response to a sourcing step from 4mA to 5mA , and Figure 6 is the output response of a sinking step from -4mA to -5mA .

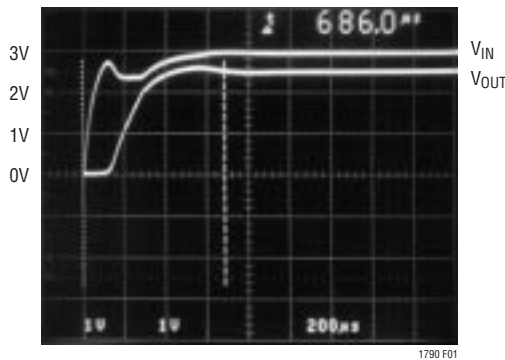

Figure 1. Turn-On Characteristics of LT1790-2.5

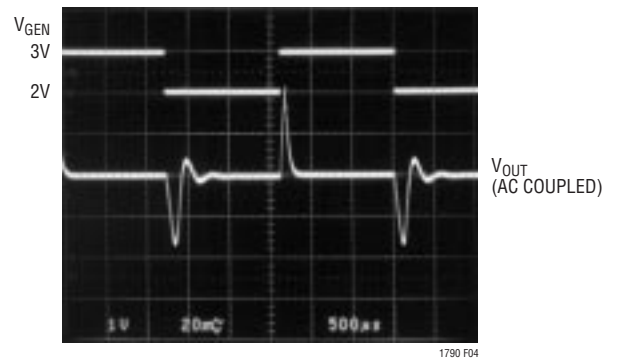

Figure 4. LT1790-2.5 Sourcing and Sinking 0.5mA

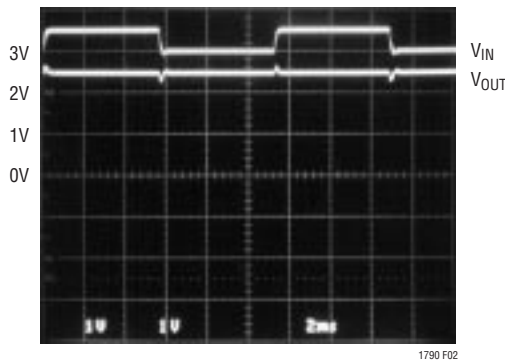

Figure 2. Output Response to 0.5V Ripple on V_{IN}

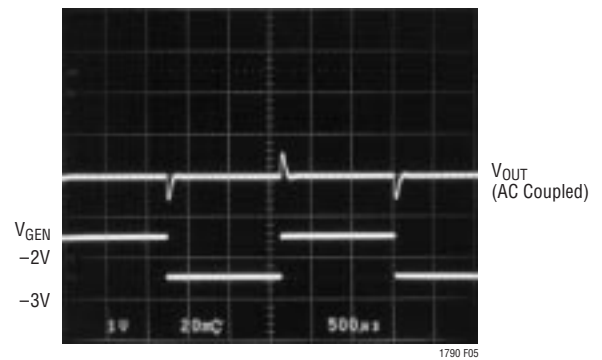

Figure 5. LT1790-2.5 Sourcing 4mA to 5mA

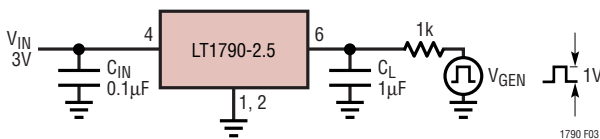

Figure 3. Response Time Test Circuit

APPLICATIONS INFORMATION

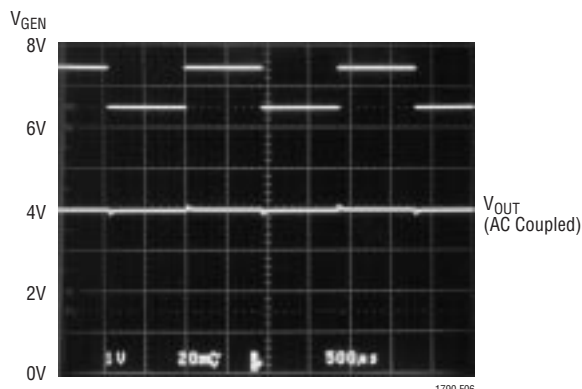

Figure 6. LT1790-2.5 Sinking –4mA to –5mA

Positive or Negative Operation

Series operation is ideal for extending battery life. If an LT1790 is operated in series mode it does not require an external current setting resistor. The specifications guarantee that the LT1790 family operates to 18V. When the circuitry being regulated does not demand current, the series connected LT1790 consumes only a few hundred μW , yet the same connection can sink or source 5mA of load current when demanded. A typical series connection is shown on the front page of this data sheet.

The circuit in Figure 7 shows the connection for a –2.5V reference, although any LT1790 voltage option can be configured this way to make a negative reference. The LT1790 can be used as very stable negative references, however, they require a positive voltage applied to Pin 4 to bias internal circuitry. This voltage must be current limited with R1 to keep the output PNP transistor from turning on and driving the grounded output. C1 provides

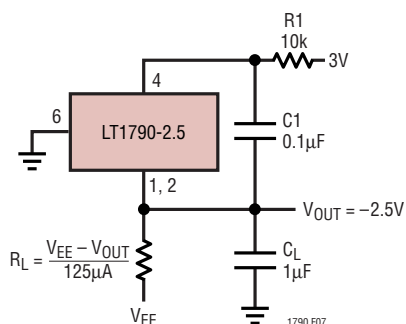

Figure 7. Using the LT1790-2.5 to Build a –2.5V Reference

stability during load transients. This connection maintains nearly the same accuracy and temperature coefficient of the positive connected LT1790.

Long-Term Drift

Long-term drift cannot be extrapolated from accelerated high temperature testing. This erroneous technique gives drift numbers that are widely optimistic. The only way long-term drift can be determined is to measure it over the time interval of interest. The LT1790S6 drift data was taken on over 100 parts that were soldered into PC boards similar to a “real world” application. The boards were then placed into a constant temperature oven with $T_A = 30^\circ\text{C}$, their outputs scanned regularly and measured with an 8.5 digit DVM. Long-term drift curves are shown in the Typical Performance Characteristics.

Hysteresis

Hysteresis data shown in Figures 8 and 9 represent the worst-case data taken on parts from 0°C to 70°C and from -40°C to 85°C . Units were cycled several times over these temperature ranges and the largest change is shown. As expected, the parts cycled over the higher temperature range have higher hysteresis than those cycled over the lower range.

When an LT1790 is IR reflow soldered onto a PC board, the output shift is typically just 150ppm (0.015%).

Higher Input Voltage

The circuit in Figure 10 shows an easy way to increase the input voltage range of the LT1790. The zener diode can be anywhere from 6V to 18V. For equal power sharing between R1 and the zener (at 30V), the 18V option is better. The circuit can tolerate much higher voltages for short periods and is suitable for transient protection.

Assuming $80\mu\text{A}$ max supply current for the LT1790, a $25\mu\text{A}$ load, 120mV max dropout and a 4V to 30V input specification, the largest that R1 can be is $(4V - 3.3V - 120\text{mV}) / (80\mu\text{A} + 25\mu\text{A}) = 5.5\text{k}$. Furthermore, assuming 220mW of dissipation in the 18V SOT-23 zener, this gives a max current of $(220\text{mW}) / (18V) = 12.2\text{mA}$. So the smallest that R1 should be is $(30V - 18V) / 12.2\text{mA} = 1\text{k}$, rated at 150mW.

APPLICATIONS INFORMATION

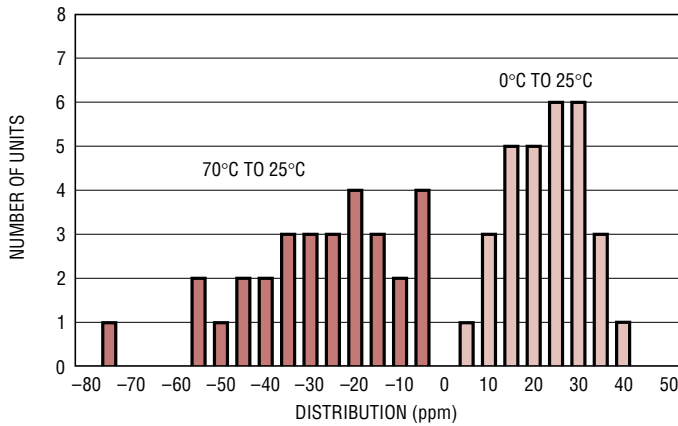

Figure 8. Worst-Case 0°C to 70°C Hysteresis on 30 Units

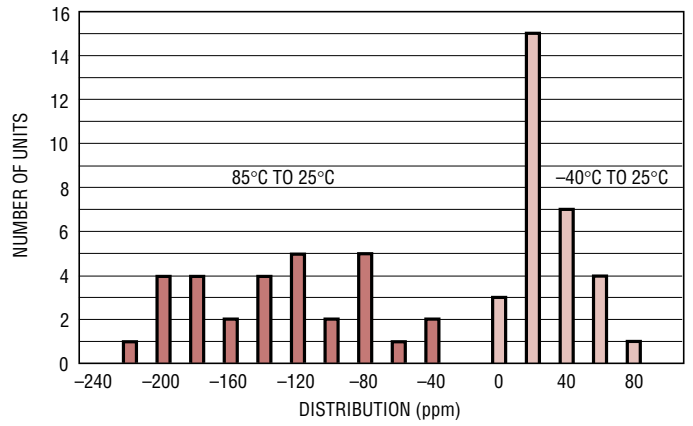

Figure 9. Worst-Case -40°C to 85°C Hysteresis on 30 Units

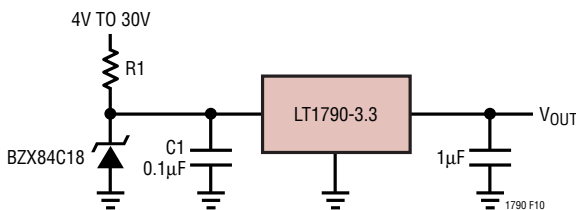

Figure 10. Extended Supply Range Reference

With $R1 = 1k$, and assuming a 450mV worst-case dropout, the LT1790 can deliver a minimum current of $(4V - 3.3V - 450mV)/(1k) = 250\mu A$. In Figure 10, R1 and C1 provide filtering of the zener noise when the zener is in its noisy V-I knee.

There are other variations for higher voltage operation that use a pass transistor shown in Figures 11 and 12. These circuits allow the input voltage to be as high as 160V while maintaining low supply current.

More Output Current

The circuit in Figure 13 is a compact, high output current, low dropout precision supply. The circuit uses the SOT-23 LT1782 and the ThinSOT LT1790. Resistive divider R1 and R2 set a voltage 22mV below V_S . For under 1mA of output current, the LT1790 supplies the load. Above 1mA of load current, the (+) input of the LT1782 is pulled below the 22mV divider reference and the output FET turns on to supply the load current. Capacitor C1 stops oscillations in

the transition region. The no load standing current is only 120µA, yet the output can deliver over 300mA.

Noise

An estimate of the total integrated noise from 10Hz to 1kHz can be made by multiplying the flat band spot noise by \sqrt{BW} . For example, from the Typical Performance Curves, the LT1790-1.25 noise spectrum shows the average spot noise to be about $450nV/\sqrt{Hz}$. The square root of the bandwidth is $\sqrt{990} = 31.4$. The total noise 10Hz to 1kHz noise is $(450nV)(31.4) = 14.1\mu V$. This agrees well with the measured noise.

This estimate may not be as good with higher voltage options, there are several reasons for this. Higher voltage options have higher noise and they have higher variability due to process variations. 10Hz to 1kHz noise may vary by 2dB on the LT1790-5 and 1dB on the LT1790-2.5.

Measured noise may also vary because of peaking in the noise spectrum. This effect can be seen in the range of 1kHz to 10kHz with all voltage options sourcing different load currents. From the Typical Performance Curves the 10Hz to 1kHz noise spectrum of the LT1790-5 is shown to be $3\mu V/\sqrt{Hz}$ at low frequency. The estimated noise is $(3\mu V)(31.4) = 93.4\mu V$. The actual integrated 10Hz to 1kHz noise measures 118.3µV. The peaking shown causes this larger number. Peaking is a function of output capacitor as well as load current and process variations.

APPLICATIONS INFORMATION

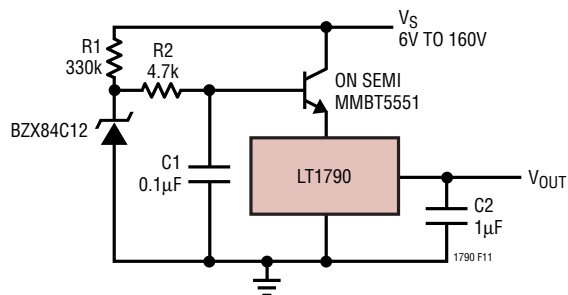

Figure 11. Extended Supply Range Reference

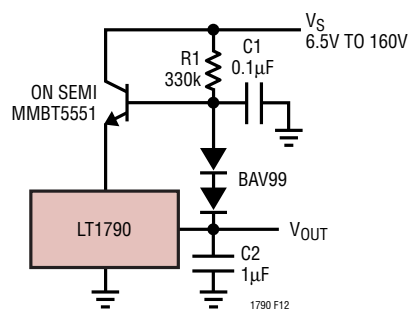

Figure 12. Extended Supply Range Reference

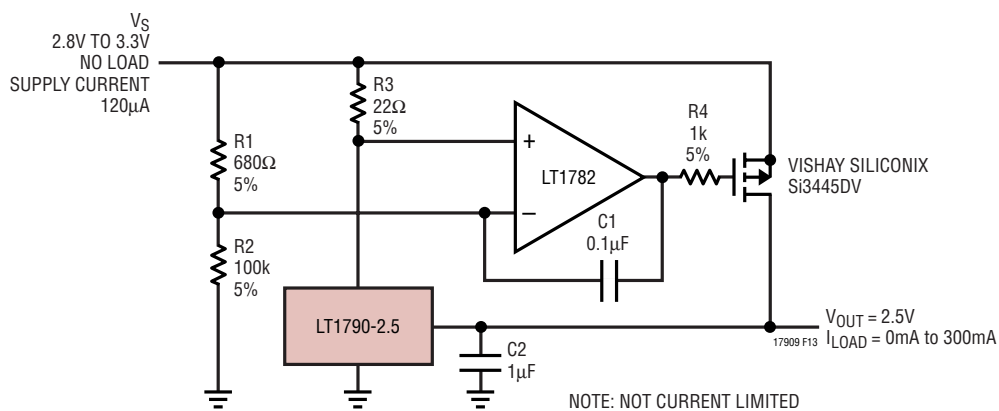
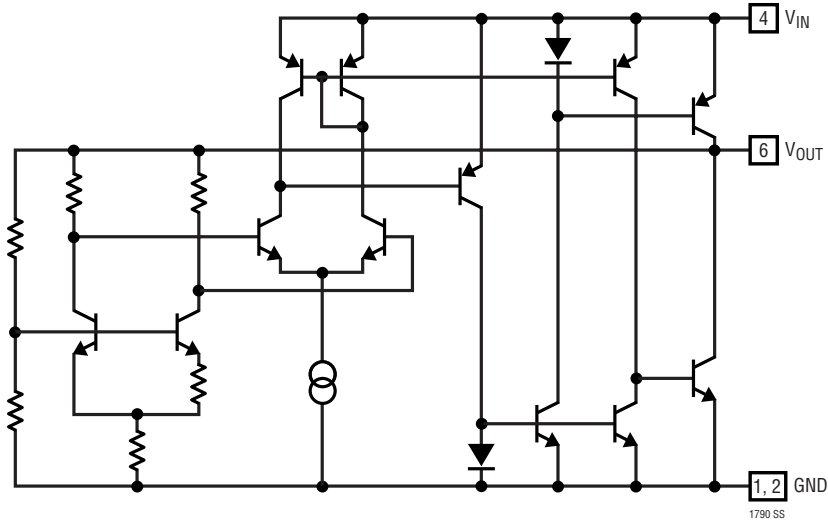

Figure 13. Compact, High Output Current, Low Dropout, Precision 2.5V Supply

SIMPLIFIED SCHEMATIC



PACKAGE DESCRIPTION

S6 Package
6-Lead Plastic SOT-23
 (Reference LTC DWG # 05-08-1636)

	SOT-23 (Original)	SOT-23 (ThinSOT)
A	.90 – 1.45 (.035 – .057)	1.00 MAX (.039 MAX)
A1	.00 – 0.15 (.00 – .006)	.01 – .10 (.0004 – .004)
A2	.90 – 1.30 (.035 – .051)	.80 – .90 (.031 – .035)
L	.35 – .55 (.014 – .021)	.30 – .50 REF (.012 – .019 REF)

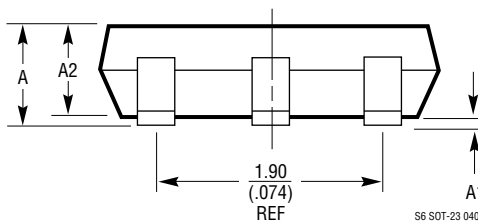
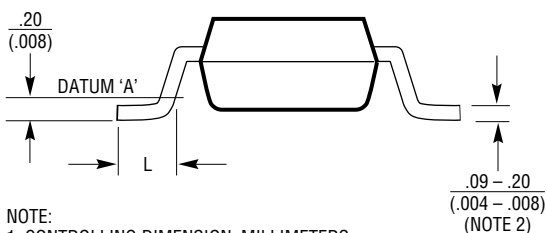
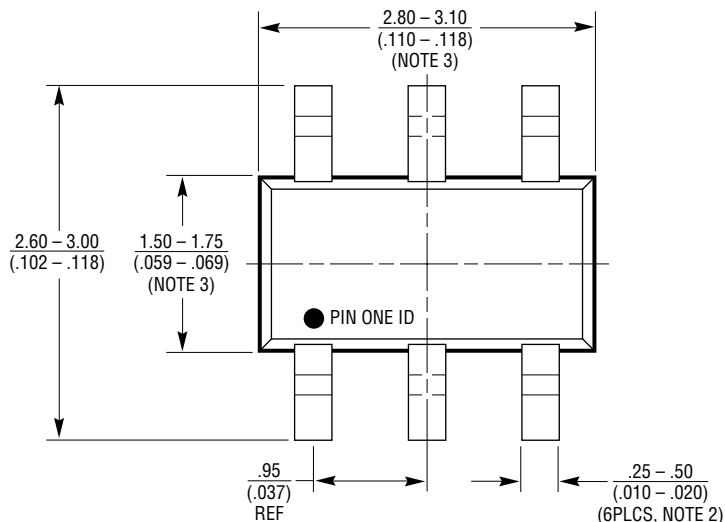

- NOTE:
1. CONTROLLING DIMENSION: MILLIMETERS
 2. DIMENSIONS ARE IN $\frac{\text{MILLIMETERS}}{\text{(INCHES)}}$
 3. DRAWING NOT TO SCALE
 4. DIMENSIONS ARE INCLUSIVE OF PLATING
 5. DIMENSIONS ARE EXCLUSIVE OF MOLD FLASH AND METAL BURR
 6. MOLD FLASH SHALL NOT EXCEED .254mm
 7. PACKAGE EIAJ REFERENCE IS:
 SC-74A (EIAJ) FOR ORIGINAL
 JEDEC MO-193 FOR THIN

TYPICAL APPLICATION

-2.5V Negative 50mA Series Reference
No Load Supply Current
 $I_{CC} = 1.6\text{mA}$
 $I_{EE} = 440\mu\text{A}$

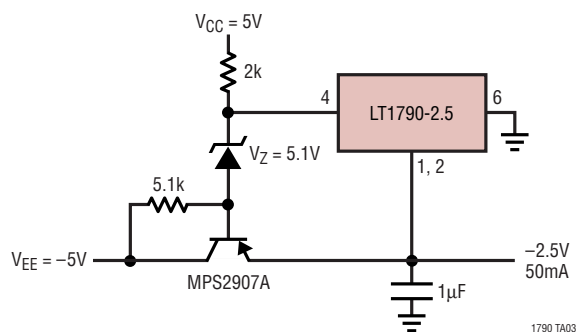

1790 TA03

RELATED PARTS

PART NUMBER	DESCRIPTION	COMMENTS
LT1019	Precision Reference	Low Noise Bandgap, 0.05%, 5ppm/°C
LTC®1798	Micropower Low Dropout Reference	0.15% Max, 6.5µA Supply Current
LT1460	Micropower Precision Series Reference	Bandgap, 130µA Supply Current, 10ppm/°C, Available in SOT-23
LT1461	Micropower Precision Low Dropout Reference	Bandgap 0.04%, 3ppm/°C, 50µA Max Supply Current