



LZ Series

CHIP TYPE, LOW IMPEDANCE

- Low impedance, temperature range up to +105°C
- Load life of 1000~2000 hours
- Comply with the RoHS directive (2002/95/EC)



SPECIFICATIONS

Items	Characteristics															
Operation Temperature Range	-55 ~ +105°C															
Rated Working Voltage	6.3 ~ 50V															
Capacitance Tolerance	±20% at 120Hz, 20°C															
Leakage Current	$I \leq 0.01CV$ or $3\mu A$ whichever is greater (after 2 minutes) I: Leakage current (μA) C: Normal capacitance (μF) V: Rated voltage (V)															
Dissipation Factor max.	Measurement frequency: 120Hz, Temperature: 20°C															
	<table border="1"> <thead> <tr> <th>WV</th> <th>6.3</th> <th>10</th> <th>16</th> <th>25</th> <th>35</th> <th>50</th> </tr> </thead> <tbody> <tr> <td>$\tan \delta$</td> <td>0.22</td> <td>0.19</td> <td>0.16</td> <td>0.14</td> <td>0.12</td> <td>0.12</td> </tr> </tbody> </table>	WV	6.3	10	16	25	35	50	$\tan \delta$	0.22	0.19	0.16	0.14	0.12	0.12	
WV	6.3	10	16	25	35	50										
$\tan \delta$	0.22	0.19	0.16	0.14	0.12	0.12										
Low Temperature Characteristics (Measurement frequency: 120Hz)	Rated voltage (V)															
	<table border="1"> <thead> <tr> <th>Impedance ratio ZT/Z20 (max.)</th> <th>Z(-25°C) / Z(20°C)</th> <th>6.3</th> <th>10</th> <th>16</th> <th>25</th> <th>35</th> <th>50</th> </tr> </thead> <tbody> <tr> <td></td> <td>Z(-40°C) / Z(20°C)</td> <td>5</td> <td>4</td> <td>4</td> <td>3</td> <td>3</td> <td>3</td> </tr> </tbody> </table>	Impedance ratio ZT/Z20 (max.)	Z(-25°C) / Z(20°C)	6.3	10	16	25	35	50		Z(-40°C) / Z(20°C)	5	4	4	3	3
Impedance ratio ZT/Z20 (max.)	Z(-25°C) / Z(20°C)	6.3	10	16	25	35	50									
	Z(-40°C) / Z(20°C)	5	4	4	3	3	3									
Load Life (After 2000 hours (1000 hours for $\varnothing 4$, $\varnothing 5$, $\varnothing 6.3 \times 5.4$) application of the rated voltage at 105°C, capacitors meet the characteristics requirements listed.)	Capacitance Change															
	Dissipation Factor															
	Leakage Current															
Shelf Life	After leaving capacitors under no load at 105°C for 1000 hours, they meet the specified value for load life characteristics listed above.															
Resistance to Soldering Heat	Capacitance Change															
	Dissipation Factor															
	Leakage Current															
Reference Standard	JIS C-5141 and JIS C-5102															

DRAWING (Unit: mm)

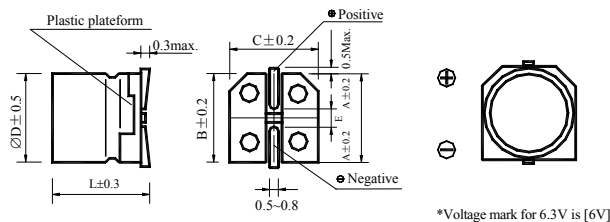

DIMENSIONS (Unit: mm)

ØD x L	4 x 5.4	5 x 5.4	6.3 x 5.4	6.3 x 7.7	8 x 10.5	10 x 10.5
A	1.8	2.1	2.4	2.4	2.9	3.2
B	4.3	5.3	6.6	6.6	8.3	10.3
C	4.3	5.3	6.6	6.6	8.3	10.3
E	1.0	1.3	2.2	2.2	3.1	4.5
L	5.4	5.4	5.4	7.7	10.5	10.5

DB LECTRO^U_Z

LZ Series

DIMENSIONS & MAXIMUM PERMISSIBLE RIPPLE CURRENT

WV μF	6.3			10			16		
	Case size	Impedance	R.C.	Case size	Impedance	R.C.	Case size	Impedance	R.C.
10							4 x 5.4	3.0	60
15							5 x 5.4 (4 x 5.4)	1.8 (3.0)	95 (60)
22	4 x 5.4	3.0	60	5 x 5.4 (4 x 5.4)	1.8 (3.0)	95 (60)	5 x 5.4 (4 x 5.4)	1.8 (3.0)	95 (60)
33	5 x 5.4 (4 x 5.4)	1.8 (3.0)	95 (60)	5 x 5.4 (4 x 5.4)	1.8 (3.0)	95 (60)	6.3 x 5.4 (5 x 5.4)	1.0 (1.8)	140 (95)
47	5 x 5.4 (4 x 5.4)	1.8 (3.0)	95 (60)	6.3 x 5.4 (5 x 5.4)	1.0 (1.8)	140 (95)	6.3 x 5.4 (5 x 5.4)	1.0 (1.8)	140 (95)
68	6.3 x 5.4 (5 x 5.4)	1.0 (1.8)	140 (95)	6.3 x 5.4	1.0	140	6.3 x 7.7 (6.3 x 5.4)	0.6 (1.0)	230 (140)
100	6.3 x 5.4 (5 x 5.4)	1.0 (1.8)	140 (95)	6.3 x 7.7 (6.3 x 5.4)	0.6 (1.0)	230 (140)	6.3 x 7.7 (6.3 x 5.4)	0.6 (1.0)	230 (140)
150	6.3 x 7.7 (6.3 x 5.4)	0.6 (1.0)	230 (140)	6.3 x 7.7 (6.3 x 5.4)	0.6 (1.0)	230 (140)	6.3 x 7.7	0.6	230
220	6.3 x 7.7 (6.3 x 5.4)	0.6 (1.0)	230 (140)	6.3 x 7.7	0.6	230	8 x 10.5 (6.3 x 7.7)	0.30 (0.6)	450 (230)
330	6.3 x 7.7	0.6	230	8 x 10.5	0.30	450	10 x 10.5 (8 x 10.5)	0.15 (0.30)	670 (450)
470	8 x 10.5	0.30	450	8 x 10.5	0.30	450	10 x 10.5 (8 x 10.5)	0.15 (0.30)	670 (450)
680	8 x 10.5	0.30	450	10 x 10.5	0.15	670	10x 10.5	0.15	670
1000	10 x 10.5 (8 x 10.5)	0.15 (0.30)	670 (450)	10 x 10.5	0.15	670	10 x 10.5	0.15	670
1500	10 x 10.5	0.15	670						

WV μF	25			35			50		
	Case size	Impedance	R.C.	Case size	Impedance	R.C.	Case size	Impedance	R.C.
1				4 x 5.4	3.0	60	4 x 5.4	5.0	30
1.5				4 x 5.4	3.0	60	4 x 5.4	5.0	30
2.2				4 x 5.4	3.0	60	4 x 5.4	5.0	30
3.3				4 x 5.4	3.0	60	4 x 5.4	5.0	30
4.7	4 x 5.4	3.0	60	4 x 5.4	3.0	60	5 x 5.4	3.0	50
6.8	4 x 5.4	3.0	60	5 x 5.4	1.8	95	6.3 x 5.4	2.0	70
10	5 x 5.4 (4 x 5.4)	1.8 (3.0)	95 (60)	5 x 5.4 (4 x 5.4)	1.8 (3.0)	95 (60)	6.3 x 5.4	2.0	70
15	6.3 x 5.4	1.8	95	5 x 5.4	1.8	95	6.3 x 5.4	2.0	70
22	6.3 x 5.4 (5 x 5.4)	1.0 (1.8)	140 (95)	6.3 x 5.4 (5 x 5.4)	1.0 (1.8)	140 (95)	6.3 x 7.7 (6.3 x 5.4)	1.0 (2.0)	120 (70)
33	6.3 x 5.4 (5 x 5.4)	1.0 (1.8)	140 (95)	6.3 x 5.4	1.0	140	6.3 x 7.7	1.0	120
47	6.3 x 7.7 (6.3 x 5.4)	0.6 (1.0)	230 (140)	6.3 x 7.7 (6.3 x 5.4)	0.60 (1.0)	230 (140)	6.3 x 7.7	1.0	120
68	6.3 x 7.7	0.6	230	6.3 x 7.7	0.60	230	8 x 10.5	0.60	300
100	6.3 x 7.7	0.6	230	8 x 10.5	0.30	450	8 x 10.5	0.60	300
150	8 x 10.5 (6.3 x 7.7)	0.30 (0.6)	450 (230)	8 x 10.5	0.30	450	10 x 10.5	0.30	500
220	8 x 10.5	0.30	450	10 x 10.5 (8 x 10.5)	0.15 (0.30)	670 (450)	10 x 10.5	0.30	500
330	10 x 10.5 (8 x 10.5)	0.15 (0.30)	670 (450)	10 x 10.5	0.15	670			
470	10 x 10.5	0.15	670	10 x 10.5	0.15	670			

Case size ∅D×L (mm), maximum impedance (Ω) at 20°C 100kHz, ripple current (mA rms) at 105°C 100kHz

FREQUENCY COEFFICIENT OF ALLOWABLE RIPPLE CURRENT

Frequency	50Hz	120Hz	300Hz	1KHz	10KHz~
Coefficient	0.35	0.50	0.64	0.83	1.00

Note: All design and specifications are for reference only and is subject to change without prior notice. If any doubt about safety for your application, please contact us immediately for technical assistance before purchase.

EXPLANATION OF PART NUMBERS

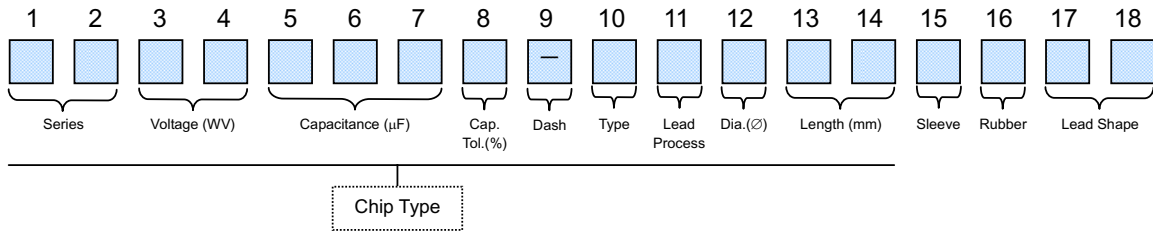

(1, 2)		(3, 4)		(5~7)		(8)		(10)		(12)		(13, 14)	
Series	Vol. (WV)	Code	Cap. (µF)	Code	Tol. (%)	Code	Type	Code	Dia. (∅)	Code	Length (mm)	Code	
CS	2	0D	0.1	0R1	+10	K	Chip	C	3	S	5	05	
CK	4	0G	0.22	R22	-10		Radial	R	4	C	5.4	54	
SC	6.3	0J	0.33	R33	+15	L	Radial Taping	T	5	D	5.8	58	
CN	10	1A	0.47	R47	-15		Snap-in	S	6.3	E	7	07	
KP	16	1C	1	010	+20	M			8	F	7.7	77	
LZ	25	1E	2.2	2R2	-20				10	G	9	09	
KZ	35	1V	3.3	3R3					12	H	10.5	10	
FZ	40	1G	4.7	4R7					12.5	I	11	11	
EL	50	1H	10	100					13	J	12	12	
KL	63	1J	22	220					13.5	V	14	14	
KH	100	2A	33	330					14.5	A	16	16	
HU	160	2C	47	470					16	K	20	20	
RA	200	2D	100	101					18	L	21	21	
RN	250	2E	220	221					20	M	25	25	
RT	315	2F	330	331					22	N	26	26	
RK	330	2U	470	471					25	O	31	31	
RM	350	2V	1000	102					30	P	35	35	
RS	400	2G	2200	222					35	Q	36	36	
LA	450	2W	3300	332					40	R	40	40	
LK			4700	472							46	46	
LM			10000	103									
LS			22000	223									
NP													
NK													
NM													
NS													
BP													
TM													
TN													
SM													
SK													

(10)		(11)	
Type	Code	Type	Code
Chip	C	Chip	Taping & Reel
Radial	R	Radial	Bulk
Radial Taping	T		Taping (Forming)
Snap-in	S		Taping (Straight)
			Lead Cut
			Lead Forming Cut
			Lead Forming Only
			Kinked Forming Cut
			Kinked Straight Cut
			Snap-in
			Lead Snap-in

(15)		(16)		(17, 18)	
Sleeve	Code	Rubber	Code	Lead Shape	Code
PVC sleeve (White printing)	W	Plane	P	Standard	00
PVC sleeve (Black printing)	B	Convexity	T	Not standard	01
PVC sleeve (Golden printing)	G			Length after cut is 3mm	30
PVC sleeve (Silver printing)	A			Length after cut is 4.5mm	45
PET sleeve (Green colour white printing)	1			Length after cut is 5mm	50
PET sleeve (Purple colour white printing)	2			Length after cut is 7.5mm	75
PET sleeve (Yellow colour black printing)	3			Length after cut is 10mm	1A

CORRESPONDING TO RoHS DIRECTIVE

Aluminum electrolytic capacitors		Chip type	Radial lead type	Snap-in type
RoHS compliant		Yes	Yes	Yes
RoHS restricted substances	Most concerns on terminals	Change plating from Sn-Pb to Sn	Change plating from Sn-Pb to Sn	Change plating from Sn-Pb to Sn
Pb	Plating on terminals			
	Construction of terminals	Fe/Cu/Sn	Fe/Cu/Sn	Fe/Cu/Sn
	Plating characters	Plating thickness 12μm Plating type matte No heat treatment after plating	Plating thickness 12μm Plating type matte No heat treatment after plating	Plating thickness 10μm Plating type matte No heat treatment after plating
	Insulating sleeve	No used	Replace PVC with PET (where customer designated)	Replace PVC with PET (where customer designated)
	Resistance to soldering heat	Please see "Lead Free Reflow Soldering Condition" for chip type aluminum electrolytic capacitors	No change	No change
	Solderability	No difference with Sn-Pb	No difference with Sn-Pb	No difference with Sn-Pb
	Tensile strength	No difference with Sn-Pb	No difference with Sn-Pb	No difference with Sn-Pb
	Whisker	<u>No difference with Sn-Pb</u> Room storage test: 20~25°C, 30~80%RH, 4000hrs. Aging test: 60±5°C, 93 +2/-3%RH, 4000hrs. Thermal cycle test: -55 +0/-10°C to 85 +10/-0°C, 3 cycles/hour, 1000 cycles	<u>No difference with Sn-Pb</u> Room storage test: 20~25°C, 30~80%RH, 4000hrs. Aging test: 60±5°C, 93 +2/-3%RH, 4000hrs. Thermal cycle test: -55 +0/-10°C to 85 +10/-0°C, 3 cycles/hour, 1000 cycles	<u>Whisker is not observed</u> Room storage test: 20~25°C, 30~80%RH, 4000hrs. Aging test: 60±5°C, 93 +2/-3%RH, 4000hrs. Thermal cycle test: -55 +0/-10°C to 85 +10/-0°C, 3 cycles/hour, 1000 cycles
Cr ⁶⁺	Plating material	< 2ppm	< 2ppm	< 2ppm
Hg		< 2ppm	< 2ppm	< 2ppm
Cd		< 2ppm	< 2ppm	< 2ppm
PBB		Not detected	Not detected	Not detected
PBDE		Not detected	Not detected	Not detected
Identification for RoHS compliance products		Add "Pb free" or "RoHS" marking on inner and outer carton label (where customer designated)	Add "Pb free" or "RoHS" marking on inner and outer carton label (where customer designated)	Add "Pb free" or "RoHS" marking on inner and outer carton label (where customer designated)
MSL Level (IPC/JEDEC J-STD-020C)		Not available No need for dry package	Not available No need for dry package	Not available No need for dry package

SERIES TABLE

Chip Type Aluminum Electrolytic Capacitors

Applications	Series	Features	Capacitance (μF)	Rate Voltage (V.D.C.)	Operating Temperature (°C)	Load Life (Hours)	Capacitance Tolerance (%)
Standard	CS	Standard size	0.1 ~ 1500	4 ~ 100	-40 ~ +85	2000	±20
	CK	Standard size, wide temperature range	0.1 ~ 1500	4 ~ 50	-55 ~ +105	2000	±20
Low Leakage Current	SC	Low leakage current	0.1 ~ 100	6.3 ~ 50	-40 ~ +85	1000	±20
Non-polarized	CN	Non-polarized	0.1 ~ 100	6.3 ~ 50	-40 ~ +85	1000	±20
	KP	Non-polarized, wide temperature range	0.1 ~ 47	6.3 ~ 50	-55 ~ +105	1000	±20
Low Impedance	LZ	Low impedance	1 ~ 1500	6.3 ~ 50	-55 ~ +105	2000	±20
	KZ	Extra low impedance	4.7 ~ 1500	6.3 ~ 50	-55 ~ +105	2000	±20
Long Life	FZ	Long life, extra low impedance	4.7 ~ 1500	6.3 ~ 35	-55 ~ +105	3000	±20
	EL	Long life assurance	0.1 ~ 1500	6.3 ~ 50	-55 ~ +105	3000	±20
	KL	5000 hours load life	0.1 ~ 4700	6.3 ~ 100	-40 ~ +105	5000	±20
High Reliability	KH	High reliability	10 ~ 330	10 ~ 50	-40 ~ +125	2000	±20
High Voltage	HU	Mid-to-high voltage	3.3 ~ 68	160 ~ 450	-40 ~ +105	5000	±20

SERIES CHART

● Chip Type Aluminum Electrolytic Capacitors

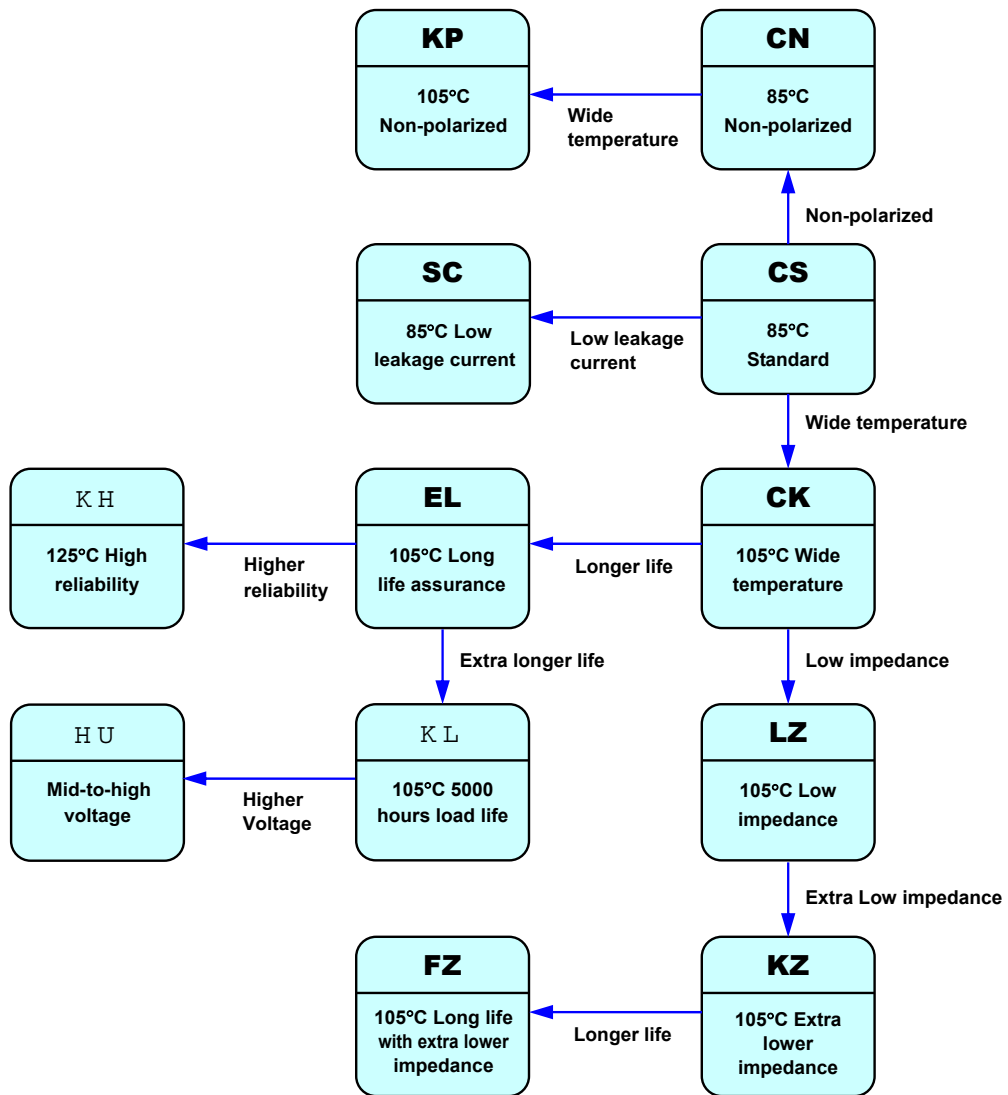

GENERAL INFORMATION FOR APPLICATION



The following precautions must be observed when using electrolytic capacitors.

1. Circuit Design

- 1) Please make sure that the environmental and mounting conditions to which the capacitor to be exposed are within the conditions specified in this catalogue.
- 2) Operating temperature and applied ripple must be within the specifications.
- 3) Appropriate capacitors, which comply with the life requirement of the products, should be selected when designing the circuit.
- 4) Aluminum electrolytic capacitors are polarized. Do not apply reserve voltage or AC voltage. Please use non-polarized capacitors for a circuit that can possibly see reserved polarity.
Note: Non-polarizes capacitors cannot be used for AC voltage application.
- 5) Do not use aluminum electrolytic capacitors in a circuit that requires rapid and very frequent charge or discharge. In this type of circuit, it is necessary to use special design capacitors with extended life characteristics.
- 6) Do not apply excess voltage.
 - ① Please pay attention so that the peak voltage, which is DC voltage overlapped by ripple current, should not exceed the rated voltage.
 - ② In the case where more than two aluminum electrolytic capacitors are used in series, please make sure that applied voltage should be lower than rated voltage should be applied to each capacitor equally using a balancing resistor in parallel with the capacitor.
- 7) Outer sleeved of the capacitor is not guarantee as an electrical insulator. Do not use standard sleeve on a capacitor in applications that require electrical insulation. When the application requires special insulation, please contact our sales office for details.
- 8) Capacitors must not be used under following conditions:
 - ① (a) Capacitors must not be exposed to water (including condensation), brine or oil.
(b) Ambient conditions that include toxic gases such as hydrogen sulfide, sulfurous acid, nitrous acid, chlorine, ammonium, etc.
(c) Ambient conditions that expose the capacitor to ozone, ultraviolet ray and radiation.
 - ② Severe vibration and physical shock conditions that exceed our specification.
Vibration test condition:
Vibration frequency range: 10~55~10Hz
Sweet rate : 10~55~10Hz per minute
Sweet method : logarithmic
Amplitude or acceleration: 1.5 (max. acceleration is 10G)
Direction of vibration : X, Y, Z direction
Testing time : 2 hours per each direction

Shock is not applicable normally.

If a particular condition is required, please contact our sales office.

- 9) When designing a circuit board, please pay attention to the following:
 - ① Make the pad spacing on the PC board matching with the lead space of the capacitor.
 - ② There should not be any circuit pattern or circuit wire above the capacitor safety vent.
- 10) The main chemical solution of the electrolyte and the separator paper in the capacitor are combustible. The electrolyte is conductive. When it comes in contact with the PC board, there is a possibility of pattern or short circuit between the circuit pattern, which could result in smoking or fire. Do not locate any circuit pattern beneath the capacitor end seal.
- 11) Do not design a circuit board so that heat generating components are placed near an aluminum electrolytic capacitor or reserve side of PC board (under the capacitor).
- 12) Please refer to the pad size layout recommendations in our catalogue when designing in surface mount capacitors.
- 13) Electrical characteristics may vary depending on changes in temperature and frequency. Please consider the variation when you design circuits.
- 14) When you install more than 2 capacitors in parallel, consider the balance of current following in to the capacitor.

2. Mounting

- 1) Once a capacitor has been assembled in the set and power applied, do not attempt to re-use the capacitor in other circuits or application.
- 2) Electric potential between positive and negative terminal may exist as a result of returned electromotive force, so please discharge the capacitor using 1K Ω resistor.
- 3) Leakage current of the parts that have stored for long period may increase. When leakage current has increased, please perform a voltage treatment using a 1K Ω resistor.
- 4) Please confirm rating and polarity before installing capacitor on the PC board.
- 5) Be careful not to deform the capacitor during installation.
- 6) Please confirm that the lead spacing of the capacitor matches the pad spacing of the PC board prior to installation.
- 7) Please pay attention to the mechanical shock to the capacitor by suction nozzle of the automatic insertion machine or automatic mounted, or by product checker, or by centering mechanism.
- 8) Reflow soldering: Please see "Lead Free Reflow Soldering Condition" for chip type aluminum electrolytic capacitors (page 8).
- 9) Do not tilt, lay down or twist the capacitor body after the capacitors are soldered to the PC board.
- 10) Do not carry the PC board by grasping the soldered capacitor.
- 11) Please do not allow anytime to touch the capacitor after soldering. If PC board are stored in stack, please make sure PC board or the other components do not touch the capacitor. The capacitor shall not be effected by any radiated heat from the soldered PC board or other components after soldering.
- 12) Cleaning
 - ① Do not clean capacitors with halogenated cleaning agent. However, if it is necessary to clean with halogenated cleaning agent, please contact our sales office.
 - ② Recommended cleaning method:
Applicable : Any type, any ratings
Cleaning agents : Pine Alpha ST-100S, cleaning through 750H/750L/710M, Sanelek B-12, Aqua Cleaner 210SEP, Techno Care FRW14~17, Isopropyl Alcohol.

Cleaning condition: Total cleaning time shall be within 5 minutes by immersion, ultrasonic or other method. Temperature of the cleaning agent shall be 60°C or lower. After cleaning, capacitors should be dried using hot air for minimum of 10 minutes along with the PC board. Hot air temperature should be below the maximum operating temperature of the capacitor. Insufficient dry after water rinse may cause appearance problems, sleeve shirk, bottom- plate bulge and such.

- ③ Avoid using ozone destructive substance for cleaning agents to concern about global environment. Please consult us regarding other cleaning agents or cleaning methods.

3. In The Equipment

- 1) Do not directly touch terminal by hand.
- 2) Do not short between terminal by conductor, nor spill conductible liquid such as alkaline or acidic solution on or near the capacitor.
- 3) Please make sure that the ambient conditions where the set is installed will be free from spilling water or oil, direct sunlight, ultraviolet rays, radiation, poisonous gases, vibration or mechanical shock.

4. Maintenance and Inspection

Please periodically inspect the aluminum capacitors that are installed in industrial equipment. The following items should be checked:

Appearance: Remarkable abnormality such as vent operation, leaking electrolyte etc.

Electrical characteristic: Capacitance, dielectric loss tangent, leakage current etc., which are specified in this catalogue.

5. In an Emergency

- 1) If you see smoke due to operation of safety vent, turn off the main switch or pull out the plug from the outlet.
- 2) Do not draw your face to the safety vent since gas over 100°C will be emitted when the safety vent operates. If the gas has entered your eyes, please flush your eyes immediately in pure water. If you breathed the gas immediately wash out your mouth and throat with water. Do not ingest electrolyte. If your skin is exposed to electrolyte, please wash it away using soap and water.

6. Storage

- 1) Do not keep capacitor in high temperature and high humidity.

Storage conditions should be:

Temperature : +5°C ~ +35°C

Humidity : Lower than 75%

Place : Indoor

- 2) Avoid ambient conditions where capacitors can be covered with water, brine or oil.
- 3) Avoid ambient conditions where capacitors are exposed to poisonous gases such as hydrogen sulfide, sulfurous acid, nitrous acid, chlorine, ammonium etc.
- 4) Do not keep capacitor in conditions that expose the capacitor to ozone, ultraviolet ray or radiation.

7. Disposal

Please dispose capacitors in either of the following ways:

- 1) Incinerate capacitors after crushing parts or making a hole on the capacitor body.
- 2) Bury capacitors in the ground. Please have a disposal specialist do it.

LEAD FREE REFLOW SOLDERING CONDITION

(Applicable to Chip Type Aluminum Electrolytic Capacitors)

Recommended Conditions for Reflow Soldering

- (1) A thermal condition system such as infrared radiation (IR) or hot blast should be adopted, and vapor heat transfer systems (VPS) are not recommended.
- (2) Reflow soldering should be performed one time. If the capacitor has to be reflowed twice, 30 minutes must be layout between each time.
- (3) For lead-free type reflow soldering, please observe proper conditions below:
 - a) The time of preheating from 150°C to 200°C shall be within maximum 180 seconds;
 - b) The time of soldering temperature at 217°C measured on capacitors' top shall not exceed t_L (second);
 - c) The peak temperature on capacitors' top shall not exceed T_p (°C), and the time within 5°C of actual peak temperature shall not exceed t_p (second).

Classification Reflow Profile

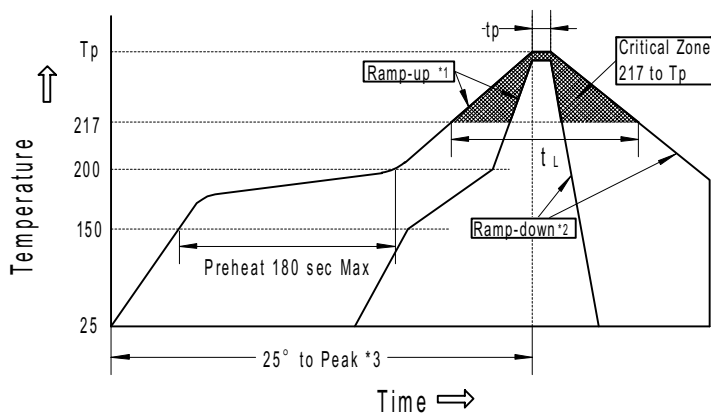

*1. Average ramp-up rate is 3°C/second max.

*2. Ramp-down rate is 6°C/second max.

*3. Time from 25°C to peak temperature is 8 minutes max.

Allowable Range of Peak Temperature

Size	Thickness (mm)	Volume (mm ³)	T_p (°C)	t_L (second)	t_p (second)
Ø4~Ø6.3, Ø8×6.2L	≥2.5	<350	250±0	90	5
Ø8×10.5L	≥2.5	350~2000	240±0	90	5
Ø10×10.5L/13.5L	≥2.5	350~2000	235±0	60	5
Ø12.5, Ø16	≥2.5	>2000	230±0	30 (20*)	5

Re: (20*) is special for mid-to-high voltage which is HU series.

Recommended Land Size (Unit: mm)

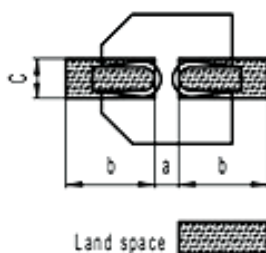

Size	a	b	c
Ø4	1.6	2.6	1.6
Ø5	1.6	3.0	1.6
Ø6.3	1.6	3.5	1.6
Ø8×6.2L	2.1	4.5	1.6
Ø8×10.5L	3.0	3.5	2.5
Ø10	4.0	4.0	2.5
Ø12.5	4.0	5.7	3.0
Ø16×16.5/21.5	6.0	6.5	3.5

Taping Specifications for Chip Type Aluminum Electrolytic Capacitors

■ Carrier Tape

Drawing 1 (for $\varnothing 4 \sim \varnothing 10$)

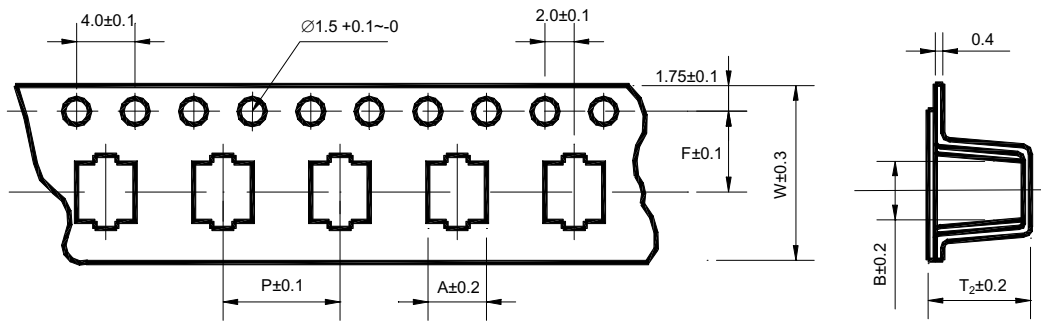

Dimension

(Unit: mm)

$\varnothing D \times L$	4×5.4/5.8	5×5.4/5.8	6.3×5.4/5.8	6.3×7.7	8×6.2	8×10.5	10×10.5/13.5
W	12.0	12.0	16.0	12.0	16.0	24.0	24.0
P	8.0	12.0	12.0	12.0	12.0	16.0	16.0
F	5.5	5.5	7.5	7.5	7.5	11.5	11.5
A	5.0	6.0	7.0	7.0	8.7	8.7	10.7
B	5.0	6.0	7.0	7.0	8.7	8.7	10.7
T ₂	5.8/6.3	5.8/6.3	5.8/6.3	8.4	6.8	11.0	11.0/14.0

Drawing 2 (for $\varnothing 12.5 \sim \varnothing 16$)

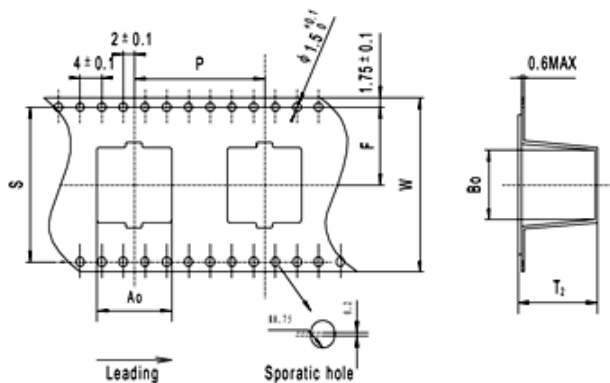

Dimension

(Unit: mm)

$\varnothing D \times L$	12.5×13.5	12.5×16
W±0.3	32.0	32.0
P±0.1	24.0	24.0
F±0.1	14.2	14.2
A ₀ ±0.2	14.0	14.0
B ₀ ±0.2	14.0	14.0
T ₂ ±0.2	14.0	16.5
S±0.1	28.4	28.4

■ Reel

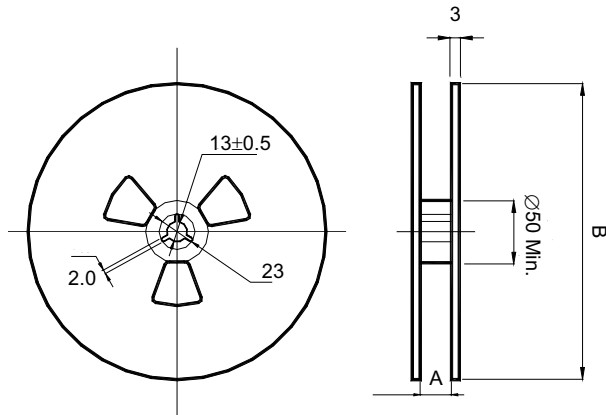

(Unit: mm)

∅D×L	4×5.4/5.8	5×5.4/5.8	6.3×5.4/5.8/7.7	8×6.2/10.5	10×10.5	10×13.5	12.5×13.5/16	16×16.5
A	14	14	18	26	26	26	34	46
B	382	382	382	382	382	382/332*	382/332*	332*

*For a small package

■ Package Quantity

Size (∅D×L)	Reel (pcs)	In-box (reels)	Quantity/In-box (pcs)	4 In-boxes/Carton (pcs)
4×5.5/5.8	2,000	6	12,000	48,000
5×5.4/5.8	1,000	6	6,000	24,000
6.3×5.4/5.8	1,000	5	5,000	20,000
6.3×7.7	1,000	5	5,000	20,000
8×6.2	1,000	5	5,000	20,000
8×10.5	500	4	2,000	8,000
10×10.5	500	4	2,000	8,000
10×13.5	300/250*	4	1,200/1,000*	4,800/4000*
12.5×13.5	200/150*	3	600/450*	2,400/1,800*
12.5×16	200/150*	3	600/450*	2,400/1,800*
16×16.5	125*	2	250*	1,000*

Note: All design and specifications are for reference only and is subject to change without prior notice. If any doubt about safety for your application, please contact us immediately for technical assistance before purchase.

LIFE OF ALUMINUM ELECTROLYTIC CAPACITORS

The life of aluminum electrolytic capacitors is mainly dependent on environmental conditions (e.g. ambient temperature, humidity etc.) and electrical factors (e.g. operating temperature, ripple current etc.) Generally, the wear-out mechanism of aluminum electrolytic capacitors is based on evaporation of electrolyte through the rubber seal. Consequently, the factor of temperature (ambient temperature and internal heating due to ripple current) is the most critical to electrolytic capacitors life. The effect of voltage on capacitor life is negligible, especially for low voltage electrolytic capacitors. The lifetime of aluminum electrolytic capacitors can be expressed as following equations:

$$L_e = L_o \cdot K_t \cdot K_r \quad \text{----- (1)}$$

Where:

L_e = Expected life at operating temperature T_e (h)

L_o = Specified life at temperature operating temperature T_o (h)

K_t = Ambient temperature acceleration term

K_r = Ripple current acceleration term

$$K_t = L_o \cdot A^{(T_o - T_e)/10} \quad \text{----- (2)}$$

Where:

T_o = Maximum rated operating temperature ($^{\circ}\text{C}$)

T_e = Actual ambient temperature ($^{\circ}\text{C}$)

A = Acceleration coefficient (for the range from 35°C to the maximum operating temperature, $A \approx 2$)

$$K_r = 2^{(-\Delta T/5)} \quad \text{----- (3)}$$

Where:

ΔT = An increase in core temperature by internal heating due to ripple current

(ΔT = core temperature – ambient temperature)

ΔT can be estimated as follows:

$$\Delta T = (I^2 \cdot R) / (\beta \cdot S) \quad \text{----- (4)}$$

Where:

I = Ripple current of the capacitor (A rms)

R = Equivalent series resistance of the capacitor (Ω)

β = Heat radiation coefficient of the aluminum can ($\text{W}/^{\circ}\text{C} \cdot \text{cm}^2$)

S = Surface area of the capacitor (cm^2)