

M31x Series Multiple Frequency VCXO

5x7 mm, 3.3/2.5/1.8 Volt, LVPECL/LVDS/CML/HCMOS Output

Product Features

- Multiple Output Frequencies (2, 3, or 4) - Selectable
- **QiK Chip™** Technology
- Superior jitter performance (less than 0.25 ps RMS, 12 kHz - 20 MHz)
- APR from ± 50 to ± 300 ppm over industrial temperature range
- SAW replacement - better performance
- Frequencies from 50 MHz - 1.4 GHz (LVDS/LVPECL/CML)
- Frequencies from 10 MHz to 150 MHz (HCMOS)

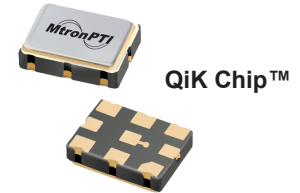

Product Description

The multiple frequency VCXO utilizes MtronPTI's QiK Chip™ technology to provide a very low jitter clock for all output frequencies. The M31x is available with up to 4 different frequency outputs from 10MHz through 1.4 GHz. Unlike traditional VCXO's where multiple crystals are required for each frequency, the M31x utilizes a rock solid fundamental 3rd overtone crystal and the QiK Chip™ IC to provide the wide range of output frequencies. Using this design approach, the M31x provides exceptional performance in frequency stability, jitter, phase noise and long term reliability.

Product Applications

- Global/Regional selection
- Forward Error Correction (FEC) / Selectable Functionality applications
- Telecommunications such as SONET / SDH / DWDM / FEC / SERDES / OC-3 thru OC-192
- 1-2-4-10 Gigabit Fibre Channel
- Wireless base stations / WLAN / Gigabit Ethernet
- xDSL, Network Communications
- Avionic flight controls
- Military Communications
- Clock and data recovery
- Low jitter clock generation
- Frequency margining

Product Ordering Information

Ordering Information	
Product Series	M31 x x x x x x x x -Sxxx
Number of Frequencies	2: Two Selectable Frequencies 3: Three Selectable Frequencies 4: Four Selectable Frequencies
Supply Voltage	0: 3.3 V 1: 2.5 V 2: 1.8 V
Operating Temperature	2: -40°C to +85°C 6: -20°C to +70°C
Absolute Pull Range (APR)	A: ± 50 ppm B: ± 100 ppm D: ± 200 ppm
Enable/Disable Function	G: Enable High (Pad 2) M: Enable Low (Pad 2)
Logic Type	P: LVPECL L: LVDS M: CML C: HCMOS
Two Frequency Select Function	2: FS0=Pad 2 *A: FS0=Pad A
Package/Lead Configuration	N: 5 x 7 mm Leadless
Factory Assigned to Accommodate	Customer Specified Frequencies - Contact Factory

*For three and four frequency selections, FS0=Pad A.

Frequency Select Truth Table		
	FS1	FS0
Frequency 1	High	High
Frequency 2	High	Low
Frequency 3	Low	High
Frequency 4	Low	Low

NOTE: Logic Low = 20% Vcc max.
Logic High = 80% Vcc min.

M3120Sxxx, M3121Sxxx, M3122Sxxx
M3130Sxxx, M3131Sxxx, M3132Sxxx
M3140Sxxx, M3141Sxxx, M3142Sxxx
Contact factory for datasheets.

M31x Series Multiple Frequency VCXO

5x7 mm, 3.3/2.5/1.8 Volt, LVPECL/LVDS/CML/HCMOS Output

Performance Characteristics

PARAMETER	Symbol	Min.	Typ.	Max.	Units	Condition/Notes
Frequency Range	F	50 10		1400 150	MHz MHz	See Note 1 LVPECL/LVDS/CML HCMOS
Operating Temperature	T _A	-20°C to +70°C or -40°C to +85°C				Customer Specified
Storage Temperature	T _S	-55		+125	°C	
Frequency Stability	ΔF/F		±25		ppm	
Aging 1st Year Thereafter (per year)		-3 -1		+3 +1	ppm ppm	
Pullability/APR		See Ordering Information				See Note 2
Gain Transfer Function			90 135 180		ppm/V ppm/V Ppm/V	For ± 50 ppm APR For ± 100 ppm APR For ± 200 ppm APR
Control Voltage	V _C	0.18 0.25 0.30	0.90 1.25 1.65	1.62 2.25 3.0	V V V	@ 1.8V V _{CC} @ 2.5V V _{CC} @ 3.3V V _{CC}
Linearity			1	5	%	Positive Monotonic
Modulation Bandwidth	f _m	10			KHz	-3 dB bandwidth
Input Impedance	Z _{in}	500k	1M		Ohms	@ DC
Supply Voltage	V _{CC}	1.71 2.375 3.135	1.8 2.5 3.3	1.89 2.625 3.465	V V V	
Input Current	I _{CC}			125 80	mA mA	LVPECL/LVDS/CML HCMOS
Load		50 Ohms to (V _{CC} - 2) V _{DC} 100 Ohm differential load				See Note 3 LVPECL Waveform LVDS/CML Waveform
				15	pF	CMOS Waveform
Symmetry (Duty Cycle)		45		55	%	LVPECL: V _{DD} - 1.3 V LVDS: 1.25 V
Output Skew			20 15 20		ps ps ps	LVPECL CML LVDS
Differential Voltage	V _{OD}	250	350	450	mV	LVDS
	V _{OD}	0.7	0.95	1.20	V _{PP}	CML
Common Mode Output Voltage	V _{CM}		1.2		V	LVDS
Logic "1" Level	V _{OH}	V _{CC} - 1.02 90% V _{DD}			V	LVPECL HCMOS
Logic "0" Level	V _{OL}			V _{CC} - 1.63 10% V _{DD}	V	LVPECL HCMOS
Rise/Fall Time	T _r /T _f		0.23	0.35 6.0	ns ns	@ 20/80% LVPECL Ref. 10%-90% V _{DD} HCMOS
Enable Function Option G		80% V _{CC} min or N/C: Output active 0.5V max: Output disables to high-Z				Customer Specified (Pad 2)
Enable Function Option M		0.5V max or N/C: Output active 80% V _{CC} min: Output disables to high-Z				Customer Specified (Pad 2)
Frequency Selection		See Truth Table				
Settling Time				10	ms	To within ± 1 ppm of frequency
Start up Time				10	ms	
Phase Jitter @ 622.08 MHz @ 125 MHz	φ _J φ _J		0.50		ps RMS ps RMS	Integrated 12 kHz - 20 MHz HCMOS (12kHz - 20 MHz)
Environmental						
Mechanical Shock		Per MIL-STD-202, Method 213, Condition C (100 g's, 6 ms duration, ½ sinewave)				
Vibration		Per MIL-STD-202, Method 201 & 204 (10 g's from 10-2000 Hz)				
Hermeticity		Per MIL-STD-202, Method 112, (1x10 ⁻⁸ atm. cc/s of Helium)				
Thermal Cycle		Per MIL-STD-883, Method 1010, Condition B (-55°C to +125°C, 15 min. dwell, 10 cycles)				
Solderability		Per EIAJ-STD-002				
Max. Soldering Cond.		See solder profile, Figure 1				

Note 1: Contact factory for standard frequency availability over 945 MHz.

Note 2: APR specification is inclusive of initial tolerance, deviation over temperature, shock, vibration, supply voltage, and aging for one year at 50°C mean ambient temperature.

Note 3: See Load Circuit Diagram in this Datasheet. Consult factory with nonstandard output load requirements.

Phase Noise Plot

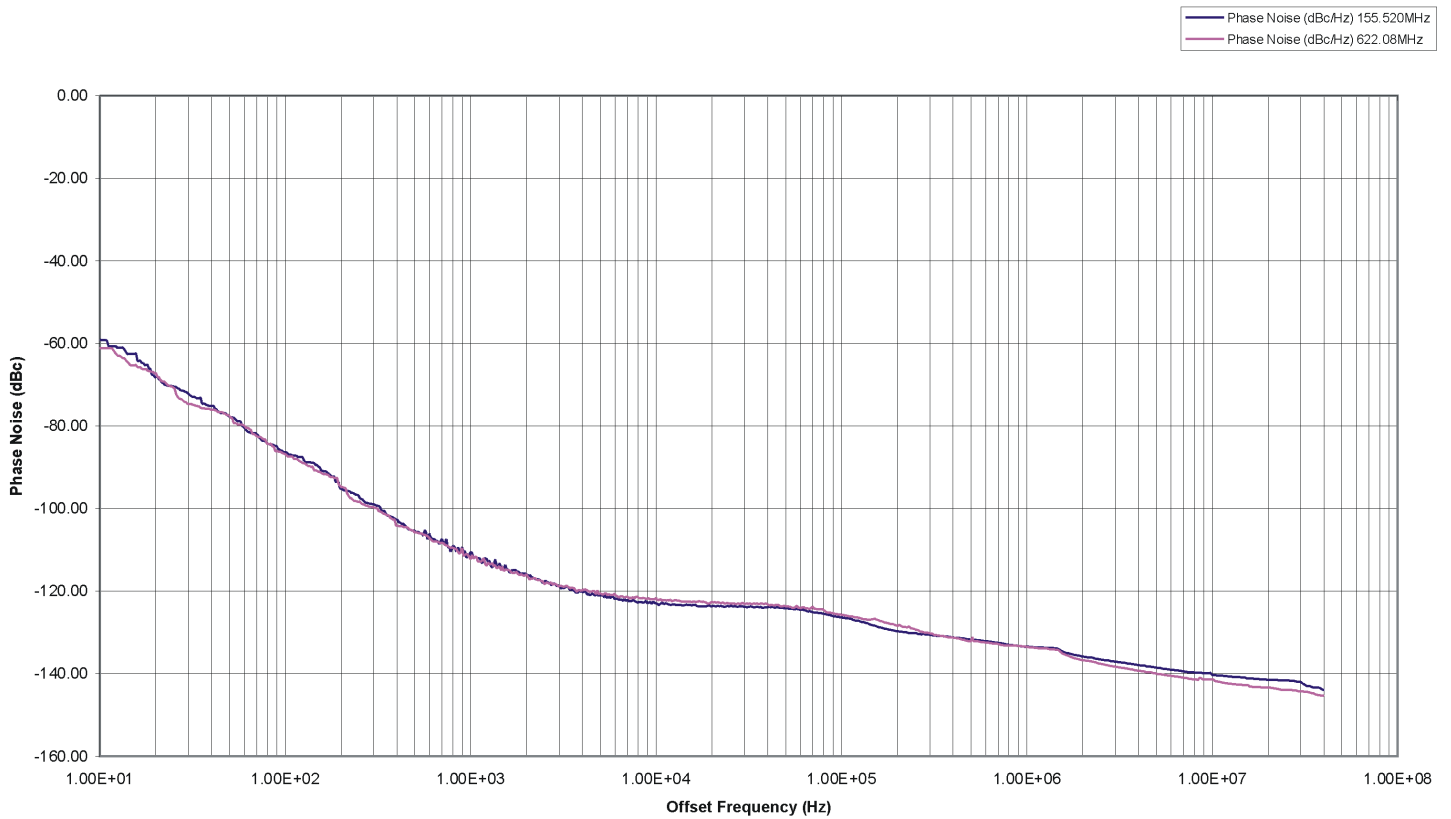

Output Waveform

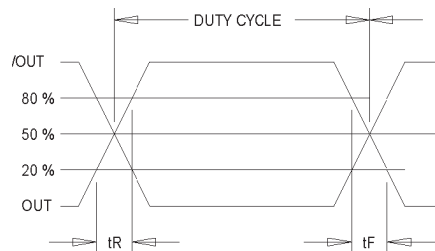

Output Waveform: LVDS / CML / LVPECL

Product Dimension & Pinout Information

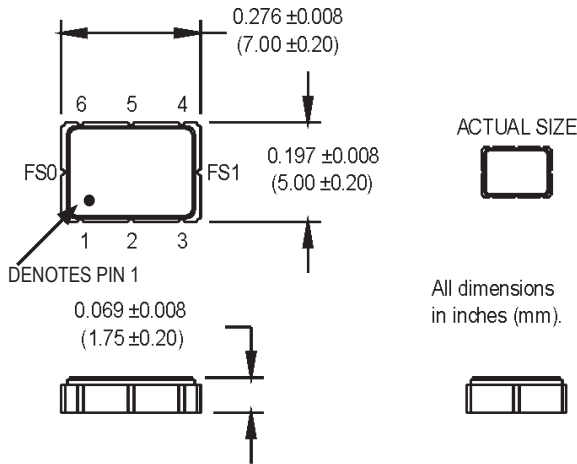

- Pad1: Voltage Control
- Pad2: Enable/Disable N/C or FS0
- Pad3: Ground
- Pad4: Output Q (LVPECL, LVDS, CML)
- Pad5: Output \bar{Q} (LVPECL, LVDS, CML)
- Pad6: Vcc
- PadA: FS0 or N/C
- PadB: FS1
- PadC: Do not connect!

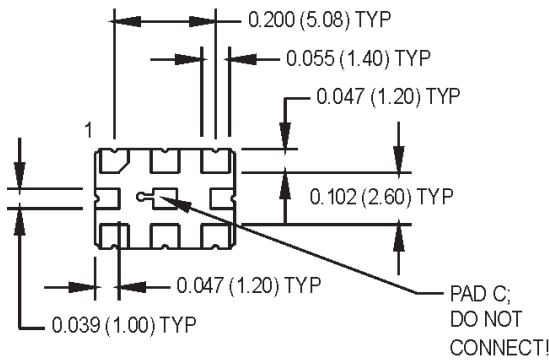

SUGGESTED SOLDER PAD LAYOUT

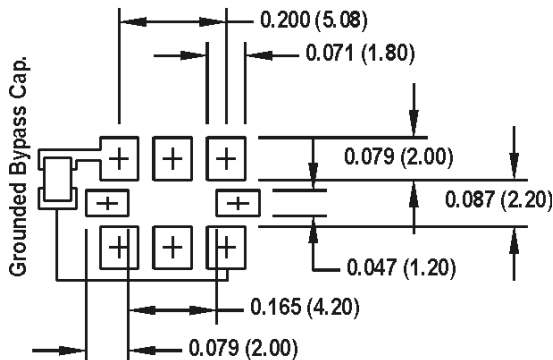

Handling Information

Although protection circuitry has been designed into the M31x oscillator, proper precautions should be taken to avoid exposure to electrostatic discharge (ESD) during handling and mounting. MtronPTI utilizes a human-body model (HBM) and a charged-device model (CDM) for ESD-susceptibility testing and protection design evaluation. ESD voltage thresholds are dependent on the circuit parameters used to define the mode. Although no industry-wide standard has been adopted for the CDM, a standard HBM (resistance = 1500 Ω, capacitance = 100 pF) is widely used and therefore can be used for comparison purposes. The HBM ESD threshold presented here was obtained using these circuit parameters.

Model	ESD Threshold, Minimum	Unit
Human Body	1500*	V
Charged Device	1500*	V

* MIL-STD-883D, Method 3015, Class 1



ATTENTION
Static Sensitive
Devices
Handle only at
Static Safe Work
Stations

Quality Parameters

Environmental Specifications/Qualification Testing Performed on the M31x VCXO		
Test	Test Method	Test Condition
Electrical Characteristics	Internal Specification	Per Specification
Frequency vs. Temperature	Internal Specification	Per Specification
Mechanical Shock	MIL-STD-202, Method 213, C	100 g's
Vibration	MIL-STD-202, Method 201-204	10 g's from 10-2000 Hz
Thermal Cycle	MIL-STD-883, Method 1010, B	-55 Deg. C to +125 Deg. C, 15 minute Dwell, 10 cycles
Aging	Internal Specification	168 Hours at 105 Degrees C
Gross Leak	MIL-STD-202, Method 112	30 Second Immersion
Fine Leak	MIL-STD-202, Method 112	Must meet 1x10 ⁻⁸
Solderability	MIL-STD-883, Method 2003	8 Hour Steam Age – Must Exhibit 95% coverage
Resistance to Solvents	MIL-STD-883, Method 2015	Three 1 minute soaks
Terminal Pull	MIL-STD-883, Method 2004, A	2 Pounds
Lead Bend	MIL-STD-883, Method 2004, B1	1 Bending Cycle
Physical Dimensions	MIL-STD-883, Method 2016	Per Specification
Internal Visual	Internal Specification	Per Internal Specification

Part Marking Guide

Line 1: Model Number
Line 2: Frequency
Line 3: Date Code
Line 4: Pin 1 Indicator / MtronPTI

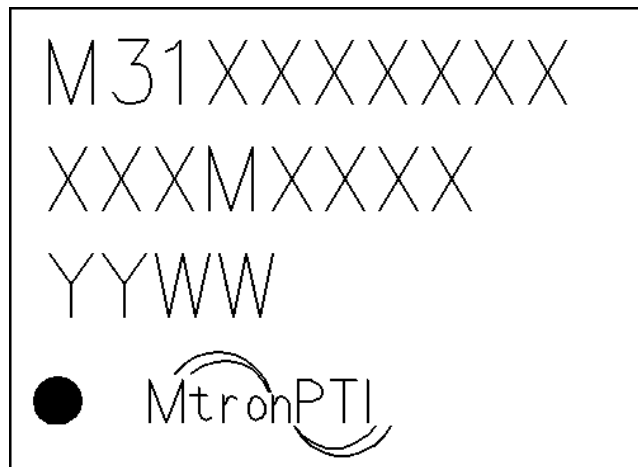

Tape & Reel Specifications

(all measurements are in mm)	A	B	C	D	E	F	G	H	I	J	K	L
M31x	6.51	9.29	1.5	7.5	2.8	4	8/12	16	180-330	13	21	60-100

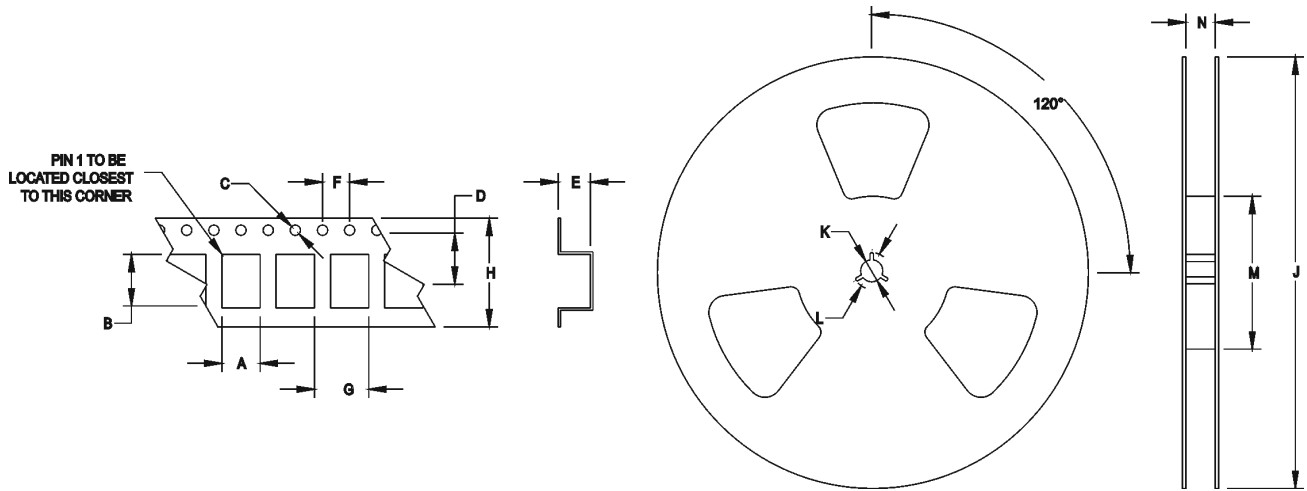

Standard Tape and Reel: 1000 parts per reel

Maximum Soldering Conditions

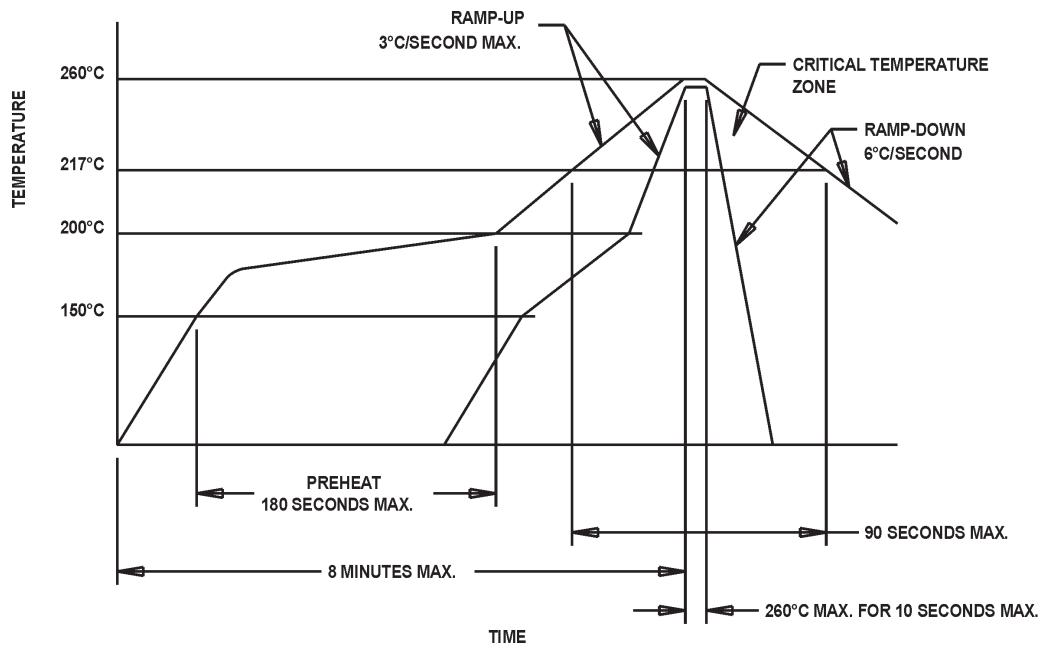

Solder Conditions

Note: Exceeding these limits may damage the device.

Typical Test Circuit & Load Circuit Diagrams

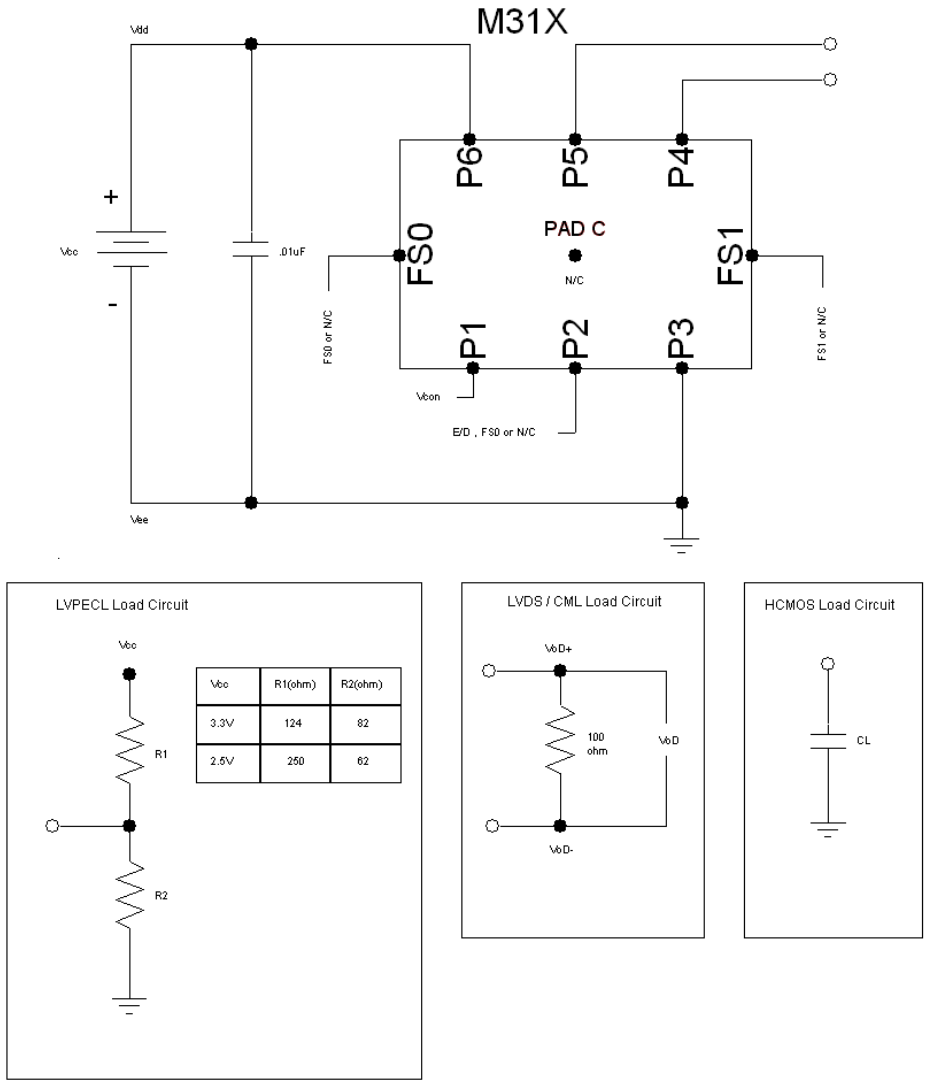

Product Revision Table

Date	Revision	PCN Number	Details of Revision
7/20/07	A	10118	IC Revision to improve phase noise and electrical performance

For custom products or additional specifications contact our sales team at **800.762.8800 (toll free) or 605.665.9321**

For more information on this product visit the MtronPTI website at **www.mtronpti.com**