

# MIL-DTL-83513/16 Thru /21 Micro-D Connectors Right Angle PCB Connectors (BR)



**High Performance** — These connectors feature gold-plated TwistPin contacts for best performance. PC tails are .020 inch diameter. Specify nickel-plated shells or cadmium plated shells for best availability.

**Solder-Dipped** — Terminals are coated with SN63/Pb37 tin-lead solder for best solderability.

## HOW TO ORDER M83513/16 THRU /21 RIGHT ANGLE PCB CONNECGTORS

Spec Number	Slash Number- Shell Size	PC Tail Length	Shell Finish	Hardware Option	
<b>M83513</b>	<b>Plug (Pin Contacts)</b>		<b>01</b> – .109 Inch (2.77 mm) <b>02</b> – .140 Inch (3.56 mm) <b>03</b> – .172 Inch (4.37 mm)	<b>C</b> – Cadmium <b>N</b> – Electroless Nickel <b>P</b> – Passivated SST	<b>N</b> – No Jackpost <b>P</b> – Jackposts Installed <b>T</b> – Threaded Insert in Board Mount Hole (No Jackposts) <b>W</b> – Threaded Insert in Board Mount Hole and jackposts Installed  (See "Hardware Options" below for Illustrations)
	<b>16-A</b>	- 9 Contacts			
	<b>16-B</b>	- 15 Contacts			
	<b>16-C</b>	- 21 Contacts			
	<b>16-D</b>	- 25 Contacts			
	<b>16-E</b>	- 31 Contacts			
	<b>16-F</b>	- 37 Contacts			
	<b>17-G</b>	- 51 Contacts			
	<b>18-H</b>	- 100 Contacts			
	<b>Receptacle (Socket Contacts)</b>		PC Tail Length ± .015 (0.38)		
	<b>19-A</b>	- 9 Contacts			
	<b>19-B</b>	- 15 Contacts			
	<b>19-C</b>	- 21 Contacts			
	<b>19-D</b>	- 25 Contacts			
	<b>19-E</b>	- 31 Contacts			
	<b>19-F</b>	- 37 Contacts			
<b>20-G</b>	- 51 Contacts				
<b>21-H</b>	- 100 Contacts				
<b>Sample Part Number</b>					
<b>M83513/</b>	<b>19-F</b>	<b>02</b>	<b>N</b>	<b>P</b>	

## HARDWARE OPTIONS

<b>N</b>	<b>P</b>	<b>T</b>	<b>W</b>
THRU HOLE	THRU HOLE	THREADED INSERT	THREADED INSERT
<b>No Jackpost</b>	<b>Jackpost</b>	<b>Threaded Insert</b>	<b>Jackpost, Threaded Insert</b>

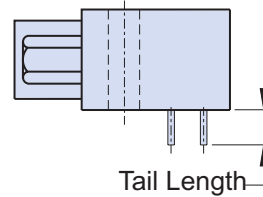
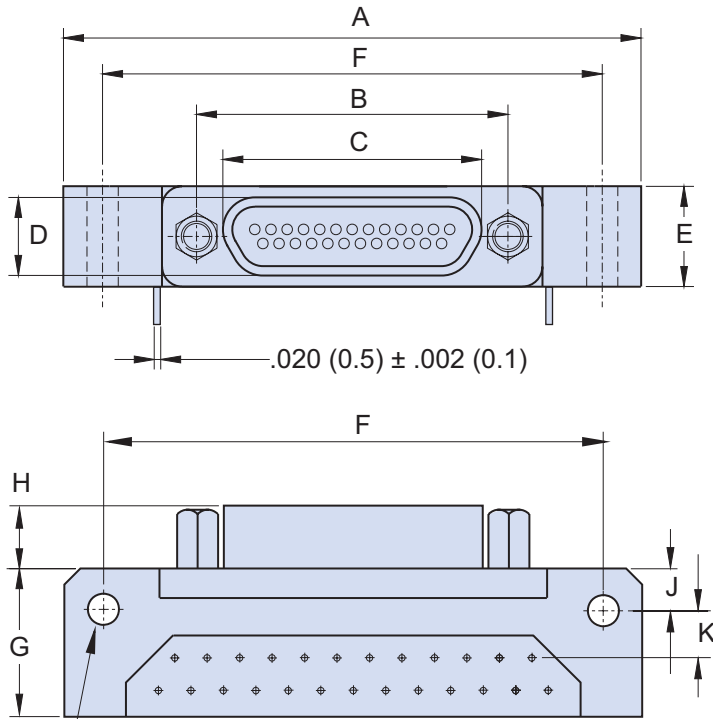

THREAD SIZES  
9-51 CONTACTS #2-56 UNC  
100 CONTACTS #4-40 UNC

2 X PCB MTNG HOLES  
9-51 CONTACTS .096 ± .005 (2.43 ± 0.13)  
100 CONTACTS .125 ± .005 (23.18 ± 0.13)

## DIMENSIONS

Layout	A Max.		B		C Max.		D Max.		E Max.		F		G Max.		H		J		K	
	In.	mm.	In. ±.005	mm. ±0.10	In.	mm.	In.	mm.	In.	mm.	In. ±.007	mm. ±0.18	In.	mm.	In. ±.003	mm. ±0.08	In. ±.015	mm. ±0.38	In. ±.010	mm. ±0.25
9P	1.390	35.31	.565	14.35	.333	8.46	.185	4.70	.325	8.26	1.150	29.21	.465	11.81	.183	4.65	.125	3.18	.150	3.81
9S	1.390	35.31	.565	14.35	.400	10.16	.253	6.26	.325	8.26	1.150	29.21	.465	11.81	.195	4.95	.125	3.18	.150	3.81
15P	1.540	39.12	.715	18.16	.483	12.27	.185	4.70	.325	8.26	1.300	33.02	.465	11.81	.183	4.65	.125	3.18	.150	3.81
15S	1.540	39.12	.715	18.16	.551	14.00	.253	6.26	.325	8.26	1.300	33.02	.465	11.81	.195	4.95	.125	3.18	.150	3.81
21P	1.690	42.93	.865	21.97	.633	16.08	.185	4.70	.325	8.26	1.450	36.83	.465	11.81	.183	4.65	.125	3.18	.150	3.81
21S	1.690	42.93	.865	21.97	.701	17.81	.253	6.26	.325	8.26	1.450	36.83	.465	11.81	.195	4.95	.125	3.18	.150	3.81
25P	1.790	45.47	.965	24.51	.733	18.62	.185	4.70	.325	8.26	1.550	39.37	.465	11.81	.183	4.65	.125	3.18	.150	3.81
25S	1.790	45.47	.965	24.51	.801	20.35	.253	6.26	.325	8.26	1.550	39.37	.465	11.81	.195	4.95	.125	3.18	.150	3.81
31P	2.040	51.82	1.115	28.32	.883	22.43	.185	4.70	.325	8.26	1.800	45.72	.465	11.81	.183	4.65	.125	3.18	.150	3.81
31S	2.040	51.82	1.115	28.32	.951	24.16	.253	6.26	.325	8.26	1.800	45.72	.465	11.81	.195	4.95	.125	3.18	.150	3.81
37P	2.340	59.44	1.265	32.13	1.033	26.24	.185	4.70	.325	8.26	2.100	53.34	.465	11.81	.183	4.65	.125	3.18	.150	3.81
37S	2.340	59.44	1.265	32.13	1.101	27.96	.253	6.26	.325	8.26	2.100	53.34	.465	11.81	.195	4.95	.125	3.18	.150	3.81
51P	1.875	47.63	1.215	30.86	.983	24.97	.228	5.79	.360	9.14	1.600	40.64	.565	14.35	.183	4.65	.125	3.18	.150	3.81
51S	1.875	47.63	1.215	30.86	1.051	26.70	.296	7.52	.360	9.14	1.600	40.64	.565	14.35	.195	4.95	.125	3.18	.150	3.81
100P	2.780	70.60	1.800	45.72	1.383	35.13	.271	6.88	.420	10.67	2.500	63.50	.765	19.43	.183	4.65	.225	5.72	.150	3.81
100S	2.780	70.60	1.800	45.72	1.451	36.86	.333	8.64	.420	10.67	2.500	63.50	.765	19.43	.195	4.95	.225	5.72	.150	3.81

# MIL-DTL-83513/16 Thru /21 Micro-D Connectors Right Angle PCB Connectors (BR)



## M83513/16 THRU /18 PCB LAYOUTS – PIN CONNECTORS

Patterns shown are for connector mounting side of PC board. 9 Thru 51 Contacts .096 (2.44) Diameter Mounting Holes, 100 Pin .125 (3.18) Diameter

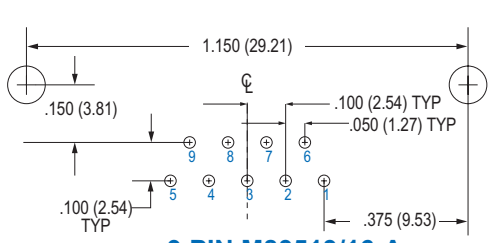

**9 PIN M83513/16-A**

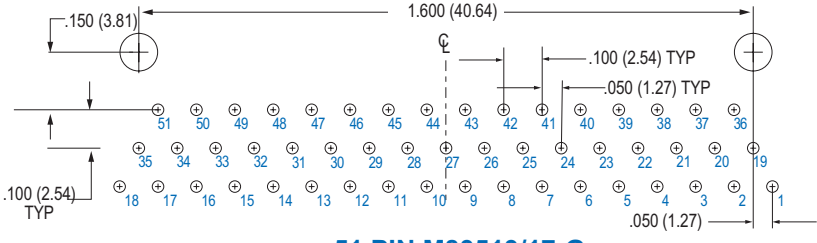

**51 PIN M83513/17-G**

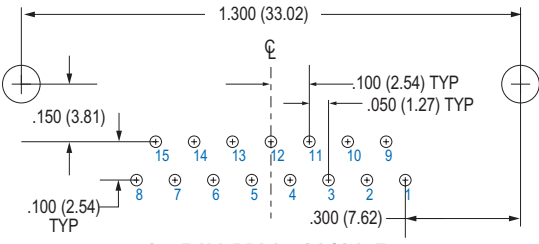

**15 PIN M83513/16-B**

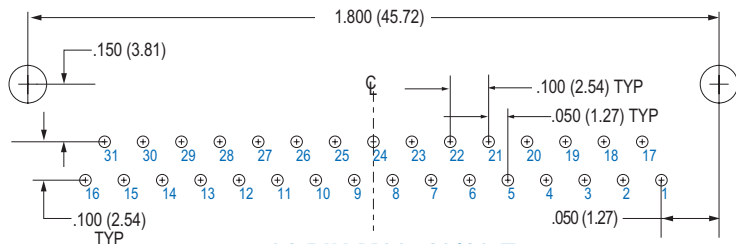

**31 PIN M83513/16-E**

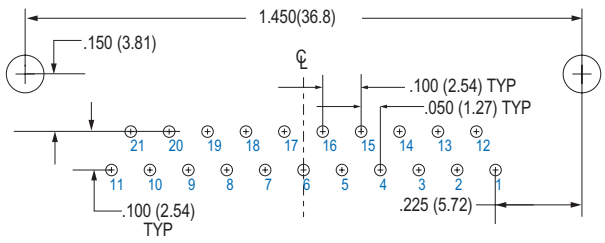

**21 PIN M83513/16-C**

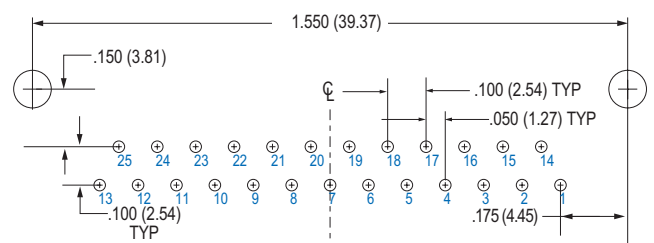

**25 PIN M83513/16-D**

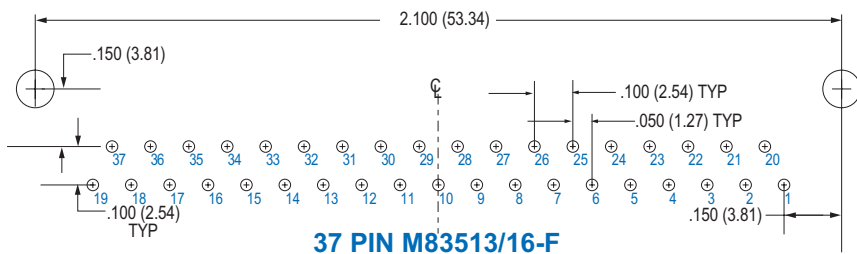

**37 PIN M83513/16-F**

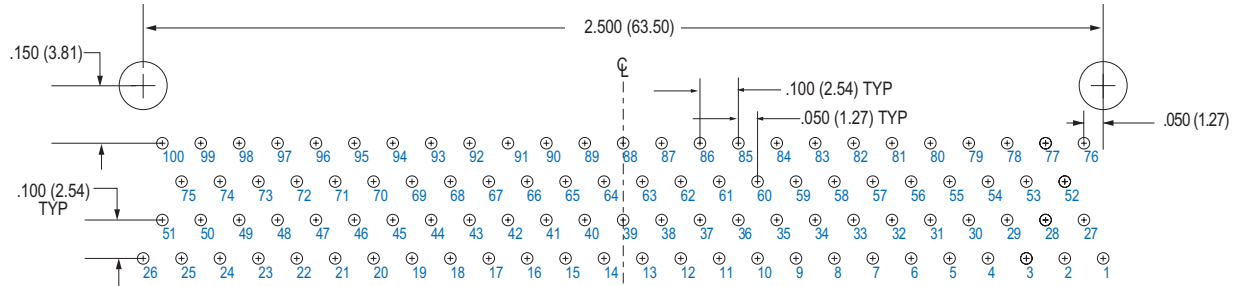

**100 PIN M83513/18-H**

J

## M83513/19 THRU /21 PCB LAYOUTS – SOCKET CONNECTORS

Patterns shown are for connector mounting side of PC board. 9 Thru 51 Contacts .096 (2.44) Diameter Mounting Holes, 100 Pin .125 (3.18) Diameter

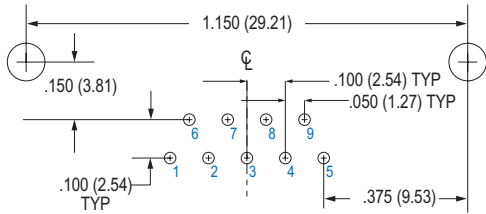

**9 SOCKET M83513/19-A**

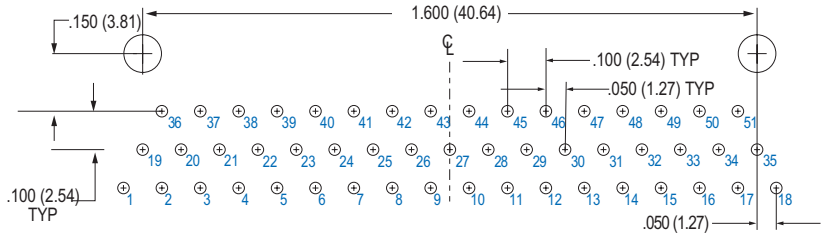

**51 SOCKET M83513/20-G**

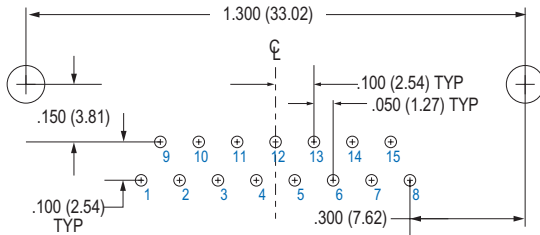

**15 SOCKET M83513/19-B**

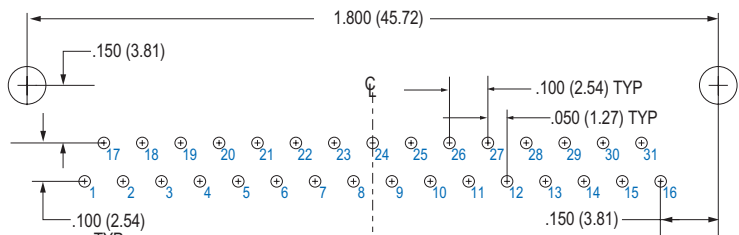

**31 SOCKET M83513/19-E**

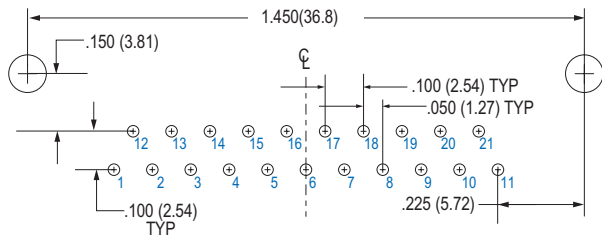

**21 SOCKET M83513/19-C**

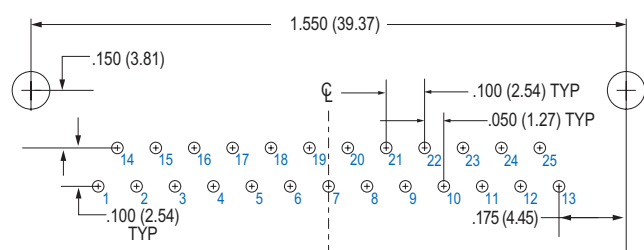

**25 SOCKET M83513/19-D**

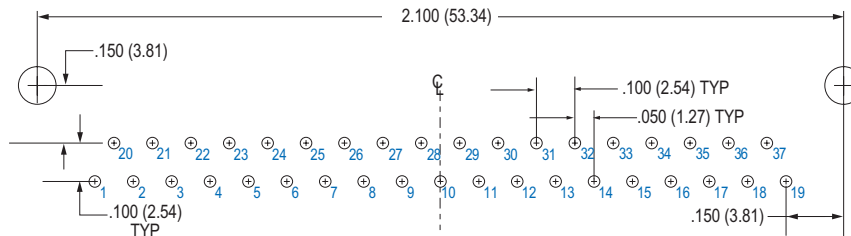

**37 SOCKET M83513/19-F**

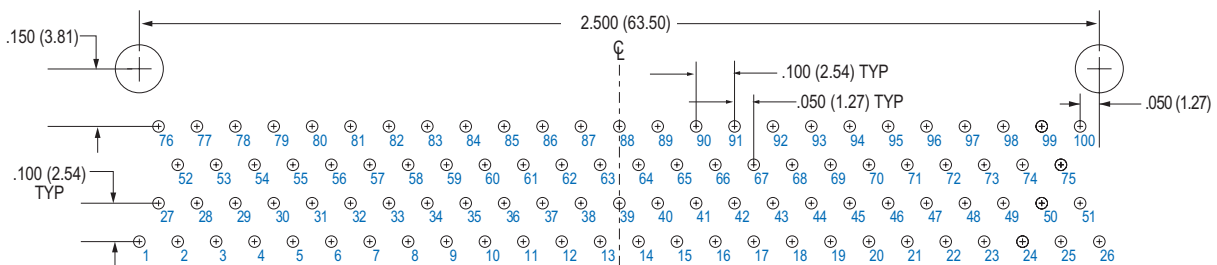

**100 SOCKET M83513/21-H**