





## Features

- Compliant with AEC-Q200 Rev-C- Stress Test Qualification for Passive Components in Automotive Applications
- 100 % electrically compatible with all previous generations of 1812 SMT devices
- Compatible with Pb and Pb-free solder reflow profiles
- RoHS compliant\* and halogen free\*\*
- Surface mount packaging for automated assembly
- Agency recognition:   
- Standard 4532 mm (1812 mils) footprint
- Patents pending

## MF-MSMF Series - PTC Resettable Fuses

### Electrical Characteristics

Model	V max. Volts	I max. Amps	I <sub>hold</sub>		I <sub>trip</sub>		Resistance		Max. Time To Trip		Tripped Power Dissipation
			Amperes at 23 °C		Ohms at 23 °C		Amperes at 23 °C	Seconds at 23 °C	Watts at 23 °C		
			Hold	Trip	R <sub>Min.</sub>	R <sub>1Max.</sub>			Typ.		
MF-MSMF010	60.0	40	0.10	0.30	0.70	15.00	0.5	1.50	0.8		
MF-MSMF014	60.0	40	0.14	0.34	0.40	6.50	1.5	0.15	0.8		
MF-MSMF020	30.0	80	0.20	0.40	0.40	6.00	6.0	0.06	0.8		
MF-MSMF020/60	60.0	40	0.20	0.40	0.40	6.00	1.5	0.15	0.8		
MF-MSMF030	30.0	10	0.30	0.60	0.30	3.00	8.0	0.10	0.8		
MF-MSMF050	15.0	100	0.50	1.00	0.15	1.00	8.0	0.15	0.8		
MF-MSMF075	13.2	100	0.75	1.50	0.11	0.45	8.0	0.20	0.8		
MF-MSMF075/24	24.0	40	0.75	1.50	0.11	0.45	8.0	0.20	0.8		
MF-MSMF110	6.0	100	1.10	2.20	0.04	0.21	8.0	0.30	0.8		
MF-MSMF110/16	16.0	100	1.10	2.20	0.04	0.21	8.0	0.30	0.8		
MF-MSMF110/24X	24.0	20	1.10	2.20	0.06	0.18	8.0	0.50	0.8		
MF-MSMF125	6.0	100	1.25	2.50	0.035	0.14	8.0	0.40	0.8		
MF-MSMF150	6.0	100	1.50	3.00	0.03	0.120	8.0	0.5	0.8		
MF-MSMF150/24X	24.0	20	1.50	3.00	0.03	0.120	8.0	1.50	1.0		
MF-MSMF160	8.0	100	1.60	2.80	0.035	0.099	8.0	2.0	0.8		
MF-MSMF200	8.0	40	2.00	4.00	0.020	0.080	8.0	3.0	0.8		
MF-MSMF250/16X	16.0	100	2.50	5.00	0.015	0.100	8.0	5.0	1.2		
MF-MSMF260	6.0	100	2.60	5.20	0.015	0.080	8.0	5.0	0.8		

### Environmental Characteristics

Operating Temperature.....	-40 °C to +85 °C	
Maximum Device Surface Temperature in Tripped State .....	125 °C	
Passive Aging .....	+85 °C, 1000 hours..... ±5 % typical resistance change	
Humidity Aging.....	+85 °C, 85 % R.H. 1000 hours .....	±5 % typical resistance change
Thermal Shock .....	+85 °C to -40 °C, 20 times.....	±10 % typical resistance change
Solvent Resistance.....	MIL-STD-202, Method 215 .....	No change
Vibration .....	MIL-STD-883C, Method 2007.1,.....	No change
	Condition A	

### Test Procedures And Requirements For Model MF-MSMF Series

Test	Test Conditions	Accept/Reject Criteria
Visual/Mech.....	Verify dimensions and materials.....	Per MF physical description
Resistance.....	In still air @ 23 °C .....	R <sub>min</sub> ≤ R ≤ R <sub>1max</sub>
Time to Trip.....	At specified current, V <sub>max</sub> , 23 °C.....	T ≤ max. time to trip (seconds)
Hold Current .....	30 min. at I <sub>hold</sub> .....	No trip
Trip Cycle Life.....	V <sub>max</sub> , I <sub>max</sub> , 100 cycles.....	No arcing or burning
Trip Endurance .....	V <sub>max</sub> , 48 hours.....	No arcing or burning
Solderability .....	ANSI/J-STD-002 .....	95 % min. coverage

UL File Number .....	E174545 <a href="http://www.ul.com/">http://www.ul.com/</a> Follow link to Certifications, then UL File No., enter E174545
CSA File Number.....	CA110338 <a href="http://directories.csa-international.org/">http://directories.csa-international.org/</a> Under "Certification Record" and "File Number" enter 110338-0-000
TÜV Certificate Number .....	R 02057213 <a href="http://www.tuvdotcom.com/">http://www.tuvdotcom.com/</a> Follow link to "other certificates", enter File No. 2057213

\*RoHS Directive 2002/95/EC Jan 27, 2003 including Annex.  
 \*\*Bourns is using the definition that appears to be the prevalent definition used as the industry standard at this time. The Bourns definition of "halogen-free" is:  
 Bromine (Br) content: ≤ 900 ppm; Chlorine (Cl) content: ≤ 900 ppm; Total Br + Cl content: ≤ 1500 ppm.  
 Specifications are subject to change without notice.

Users should verify actual device performance in their specific applications.  
 The device characteristics and parameters in this data sheet can and do vary in different applications and actual device performance may vary over time.

## Applications

- Overcurrent and overtemperature protection of automotive electronics
- Hard disk drives
- PC motherboards
- PC peripherals
- Point-of-sale (POS) equipment
- PCMCIA cards
- USB port protection - USB 2.0, 3.0 & OTG
- HDMI 1.4 Source protection

## MF-MSMF Series - PTC Resettable Fuses

**BOURNS®**

Product Dimensions (see next page for outline drawings)

Model	A		B		C		D	Style
	Min.	Max.	Min.	Max.	Min.	Max.	Min.	
MF-MSMF010	$\frac{4.37}{(0.172)}$	$\frac{4.73}{(0.186)}$	$\frac{3.07}{(0.121)}$	$\frac{3.41}{(0.134)}$	$\frac{0.70}{(0.028)}$	$\frac{1.10}{(0.043)}$	$\frac{0.30}{(0.012)}$	1
MF-MSMF014	$\frac{4.37}{(0.172)}$	$\frac{4.73}{(0.186)}$	$\frac{3.07}{(0.121)}$	$\frac{3.41}{(0.134)}$	$\frac{0.70}{(0.028)}$	$\frac{1.10}{(0.043)}$	$\frac{0.30}{(0.012)}$	1
MF-MSMF020	$\frac{4.37}{(0.172)}$	$\frac{4.73}{(0.186)}$	$\frac{3.07}{(0.121)}$	$\frac{3.41}{(0.134)}$	$\frac{0.70}{(0.028)}$	$\frac{1.10}{(0.043)}$	$\frac{0.30}{(0.012)}$	1
MF-MSMF020/60	$\frac{4.37}{(0.172)}$	$\frac{4.73}{(0.186)}$	$\frac{3.07}{(0.121)}$	$\frac{3.41}{(0.134)}$	$\frac{0.70}{(0.028)}$	$\frac{1.10}{(0.043)}$	$\frac{0.30}{(0.012)}$	1
MF-MSMF030	$\frac{4.37}{(0.172)}$	$\frac{4.73}{(0.186)}$	$\frac{3.07}{(0.121)}$	$\frac{3.41}{(0.134)}$	$\frac{0.70}{(0.028)}$	$\frac{1.10}{(0.043)}$	$\frac{0.30}{(0.012)}$	1
MF-MSMF050	$\frac{4.37}{(0.172)}$	$\frac{4.73}{(0.186)}$	$\frac{3.07}{(0.121)}$	$\frac{3.41}{(0.134)}$	$\frac{0.55}{(0.015)}$	$\frac{0.85}{(0.033)}$	$\frac{0.30}{(0.012)}$	1
MF-MSMF075	$\frac{4.37}{(0.172)}$	$\frac{4.73}{(0.186)}$	$\frac{3.07}{(0.121)}$	$\frac{3.41}{(0.134)}$	$\frac{0.55}{(0.015)}$	$\frac{0.85}{(0.033)}$	$\frac{0.30}{(0.012)}$	1
MF-MSMF075/24	$\frac{4.37}{(0.172)}$	$\frac{4.73}{(0.186)}$	$\frac{3.07}{(0.121)}$	$\frac{3.41}{(0.134)}$	$\frac{0.55}{(0.015)}$	$\frac{0.85}{(0.033)}$	$\frac{0.30}{(0.012)}$	1
MF-MSMF110	$\frac{4.37}{(0.172)}$	$\frac{4.73}{(0.186)}$	$\frac{3.07}{(0.121)}$	$\frac{3.41}{(0.134)}$	$\frac{0.45}{(0.018)}$	$\frac{0.85}{(0.033)}$	$\frac{0.30}{(0.012)}$	1
MF-MSMF110/16	$\frac{4.37}{(0.172)}$	$\frac{4.73}{(0.186)}$	$\frac{3.07}{(0.121)}$	$\frac{3.41}{(0.134)}$	$\frac{0.45}{(0.018)}$	$\frac{0.85}{(0.033)}$	$\frac{0.30}{(0.012)}$	1
MF-MSMF110/24X	$\frac{4.37}{(0.172)}$	$\frac{4.83}{(0.190)}$	$\frac{3.07}{(0.121)}$	$\frac{3.41}{(0.134)}$	$\frac{0.70}{(0.028)}$	$\frac{1.60}{(0.063)}$	$\frac{0.30}{(0.012)}$	2
MF-MSMF125	$\frac{4.37}{(0.172)}$	$\frac{4.73}{(0.186)}$	$\frac{3.07}{(0.121)}$	$\frac{3.41}{(0.134)}$	$\frac{0.55}{(0.015)}$	$\frac{0.85}{(0.033)}$	$\frac{0.30}{(0.012)}$	1
MF-MSMF150	$\frac{4.37}{(0.172)}$	$\frac{4.73}{(0.186)}$	$\frac{3.07}{(0.121)}$	$\frac{3.41}{(0.134)}$	$\frac{0.55}{(0.015)}$	$\frac{0.85}{(0.033)}$	$\frac{0.30}{(0.012)}$	1
MF-MSMF150/24X	$\frac{4.37}{(0.172)}$	$\frac{4.83}{(0.190)}$	$\frac{3.07}{(0.121)}$	$\frac{3.41}{(0.134)}$	$\frac{0.70}{(0.028)}$	$\frac{1.60}{(0.063)}$	$\frac{0.30}{(0.012)}$	2
MF-MSMF160	$\frac{4.37}{(0.172)}$	$\frac{4.73}{(0.186)}$	$\frac{3.07}{(0.121)}$	$\frac{3.41}{(0.134)}$	$\frac{0.55}{(0.015)}$	$\frac{0.85}{(0.033)}$	$\frac{0.30}{(0.012)}$	1
MF-MSMF200	$\frac{4.37}{(0.172)}$	$\frac{4.73}{(0.186)}$	$\frac{3.07}{(0.121)}$	$\frac{3.41}{(0.134)}$	$\frac{0.55}{(0.015)}$	$\frac{0.85}{(0.033)}$	$\frac{0.30}{(0.012)}$	1
MF-MSMF250/16X	$\frac{4.37}{(0.172)}$	$\frac{4.83}{(0.190)}$	$\frac{3.07}{(0.121)}$	$\frac{3.41}{(0.134)}$	$\frac{0.70}{(0.028)}$	$\frac{1.60}{(0.063)}$	$\frac{0.30}{(0.012)}$	2
MF-MSMF260	$\frac{4.37}{(0.172)}$	$\frac{4.73}{(0.186)}$	$\frac{3.07}{(0.121)}$	$\frac{3.41}{(0.134)}$	$\frac{0.48}{(0.019)}$	$\frac{0.85}{(0.033)}$	$\frac{0.30}{(0.012)}$	1

Packaging:

MF-MSMF010 through MF-MSMF030 = 1500 pcs. per reel.  
 MF-MSMF050 through MF-MSMF200 & MF-MSMF260 = 2000 pcs. per reel.  
 MF-MSMF110/24X , MF-MSMF150/24X & MF-MSMF250/16X = 1500 pcs. per reel.

DIMENSIONS:  $\frac{\text{MM}}{\text{(INCHES)}}$

# MF-MSMF Series - PTC Resettable Fuses

**BOURNS®**

## Product Dimensions (see previous page for dimensions)

### Style 1

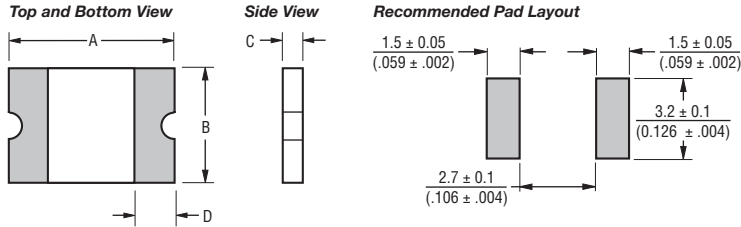

**Terminal material:**

Electroless Ni under immersion Au

**Termination pad solderability:**

Standard Au finish:  
Meets ANSI/J-STD-002 Category 2.

**Recommended Storage:**

40 °C max./70 % RH max.

### Style 2

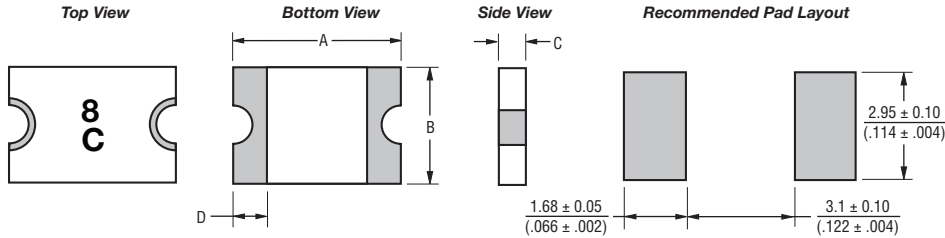

## Typical Time to Trip at 23 °C

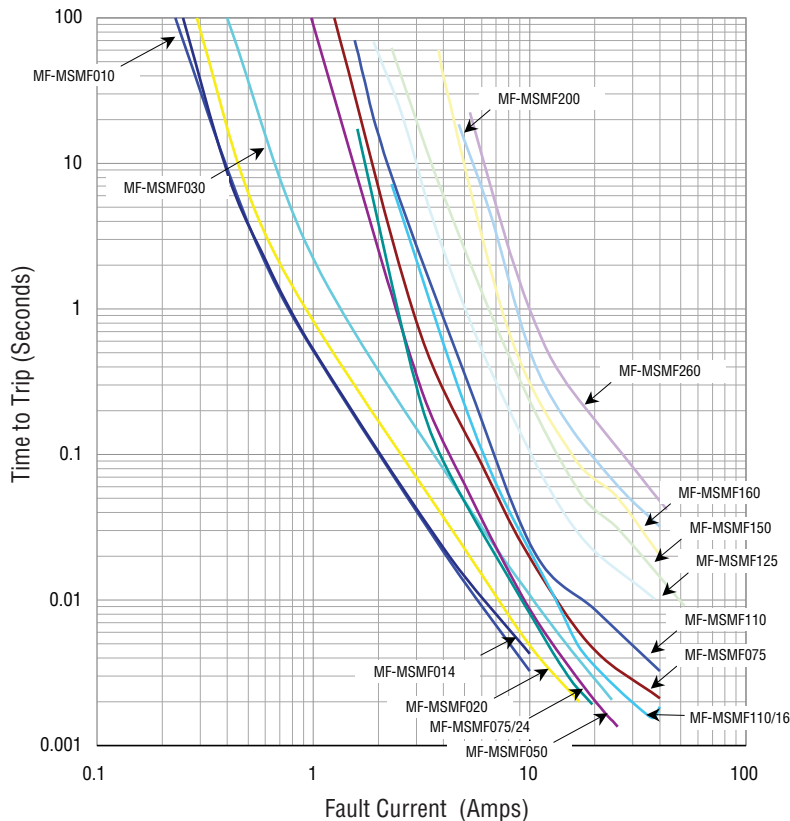

The Time to Trip curves represent typical performance of a device in a simulated application environment. Actual performance in specific customer applications may differ from these values due to the influence of other variables.

Specifications are subject to change without notice.

Users should verify actual device performance in their specific applications.

The device characteristics and parameters in this data sheet can and do vary in different applications and actual device performance may vary over time.

# MF-MSMF Series - PTC Resettable Fuses

**BOURNS®**

## Thermal Derating Chart - I<sub>hold</sub> (Amps)

Model	Ambient Operating Temperature								
	-40 °C	-20 °C	0 °C	23 °C	40 °C	50 °C	60 °C	70 °C	85 °C
MF-MSMF010	0.16	0.14	0.12	0.10	0.08	0.07	0.06	0.05	0.03
MF-MSMF014	0.23	0.19	0.17	0.14	0.12	0.10	0.09	0.08	0.06
MF-MSMF020	0.29	0.26	0.23	0.20	0.17	0.15	0.14	0.12	0.10
MF-MSMF020/60	0.29	0.26	0.23	0.20	0.17	0.15	0.14	0.12	0.10
MF-MSMF030	0.44	0.39	0.35	0.30	0.26	0.23	0.21	0.18	0.15
MF-MSMF050	0.77	0.68	0.59	0.50	0.44	0.40	0.37	0.33	0.29
MF-MSMF075	1.15	1.01	0.88	0.75	0.65	0.60	0.55	0.49	0.43
MF-MSMF075/24	1.15	1.01	0.88	0.75	0.65	0.60	0.55	0.49	0.43
MF-MSMF110	1.59	1.43	1.26	1.10	0.95	0.87	0.80	0.71	0.60
MF-MSMF110/16	1.59	1.43	1.26	1.10	0.95	0.87	0.80	0.71	0.60
MF-MSMF110/24X	2.00	1.70	1.40	1.10	0.95	0.88	0.80	0.73	0.61
MF-MSMF125	1.80	1.63	1.43	1.25	1.08	0.99	0.91	0.81	0.68
MF-MSMF150	2.17	1.95	1.72	1.50	1.30	1.18	1.09	0.97	0.82
MF-MSMF150/24X	2.10	1.90	1.70	1.50	1.25	1.13	1.00	0.88	0.69
MF-MSMF160	2.30	2.20	1.90	1.60	1.45	1.30	1.15	1.03	0.91
MF-MSMF200	3.08	2.71	2.35	2.00	1.80	1.60	1.50	1.40	1.25
MF-MSMF250/16X	3.90	3.42	2.96	2.50	2.24	1.98	1.85	1.29	0.94
MF-MSMF260	4.00	3.52	3.06	2.60	2.34	2.08	1.95	1.39	1.04

## Solder Reflow Recommendations

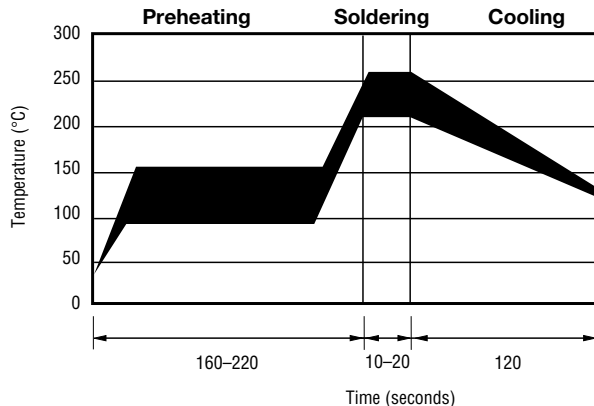

### Notes:

- MF-MSMF models cannot be wave soldered. Please contact Bourns for hand soldering recommendations.
- If reflow temperatures exceed the recommended profile, devices may not meet the performance requirements.
- Compatible with Pb and Pb-free solder reflow profiles.
- Excess solder may cause a short circuit, especially during hand soldering. Please refer to the Multifuse® Polymer PTC product soldering recommendation guidelines.

## How to Order

**MF - MSMF 075/24 - 2**

Multifuse® Product Designator  
 Series  
 MSMF = 4532 mm (1812 mils)  
 Surface Mount Component  
 Hold Current, I<sub>hold</sub>  
 010-260 (0.10 Amps - 2.60 Amps)  
 Higher Voltage Option  
 = Standard Voltage  
 /16 = 16 Volt Rated  
 /24 = 24 Volt Rated  
 /60 = 60 Volt Rated  
 X = Multifuse® freeXpansion Design™  
 MF-MSMF Series  
 Packaging  
 Packaged per EIA 481-1  
 -2 = Tape and Reel

## Typical Part Marking

Represents total content. Layout may vary.

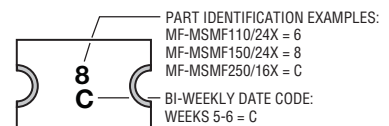
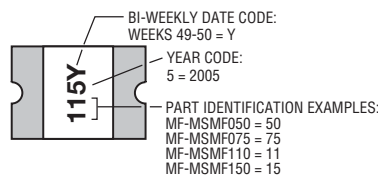

MF-MSMF SERIES, REV. AD, 02/13

"freeXpansion Design" is a trademark of Bourns, Inc. Specifications are subject to change without notice.

Users should verify actual device performance in their specific applications.

The device characteristics and parameters in this data sheet can and do vary in different applications and actual device performance may vary over time.

# MF-MSMF Series Tape and Reel Specifications

# BOURNS®

Tape Dimensions	MF-MSMF010 - MF-MSMF030 per EIA-481-1	MF-MSMF050 - MF-MSMF260 per EIA 481-1	MF-MSMF-110/24X MF-MSMF150/24X MF-MSMF250/16X per EIA 481-1
W	$12.0 \pm 0.30$ (0.472 ± 0.012)	$12.0 \pm 0.30$ (0.472 ± 0.012)	$12.0 \pm 0.30$ (0.472 ± 0.012)
P <sub>0</sub>	$4.0 \pm 0.10$ (0.157 ± 0.004)	$4.0 \pm 0.10$ (0.157 ± 0.004)	$4.0 \pm 0.10$ (0.157 ± 0.004)
P <sub>1</sub>	$8.0 \pm 0.10$ (0.315 ± 0.004)	$8.0 \pm 0.10$ (0.315 ± 0.004)	$8.0 \pm 0.10$ (0.315 ± 0.004)
P <sub>2</sub>	$2.0 \pm 0.05$ (0.079 ± 0.002)	$2.0 \pm 0.05$ (0.079 ± 0.002)	$2.0 \pm 0.05$ (0.079 ± 0.002)
A <sub>0</sub>	$3.58 \pm 0.10$ (0.141 ± 0.004)	$3.66 \pm 0.15$ (0.144 ± 0.006)	$3.70 \pm 0.10$ (0.146 ± 0.004)
B <sub>0</sub>	$4.93 \pm 0.10$ (0.194 ± 0.004)	$4.98 \pm 0.10$ (0.196 ± 0.004)	$5.10 \pm 0.10$ (0.200 ± 0.004)
B <sub>1</sub> max.	$5.9$ (0.232)	$5.9$ (0.232)	$5.9$ (0.232)
D <sub>0</sub>	$1.5 + 0.10/-0.0$ (0.059 + 0.004/-0)	$1.5 + 0.10/-0.0$ (0.059 + 0.004/-0)	$1.5 + 0.10/-0.0$ (0.059 + 0.004/-0)
F	$5.5 \pm 0.05$ (0.217 ± 0.002)	$5.5 \pm 0.05$ (0.217 ± 0.002)	$5.5 \pm 0.05$ (0.217 ± 0.002)
E <sub>1</sub>	$1.75 \pm 0.10$ (0.069 ± 0.004)	$1.75 \pm 0.10$ (0.069 ± 0.004)	$1.75 \pm 0.10$ (0.069 ± 0.004)
E <sub>2</sub> min.	$10.25$ (0.404)	$10.25$ (0.404)	$10.25$ (0.404)
T max.	$0.6$ (0.024)	$0.6$ (0.024)	$0.6$ (0.024)
T <sub>1</sub> max.	$0.1$ (0.004)	$0.1$ (0.004)	$0.1$ (0.004)
K <sub>0</sub>	$1.30 \pm 0.10$ (0.051 ± 0.004)	$0.95 \pm 0.10$ (0.037 ± 0.004)	$1.50 \pm 0.10$ (0.059 ± 0.004)
Leader min.	$390$ (15.35)	$390$ (15.35)	$390$ (15.35)
Trailer min.	$160$ (6.30)	$160$ (6.30)	$160$ (6.30)
<b>Reel Dimensions</b>			
A max.	$185$ (7.28)	$185$ (7.28)	$185$ (7.28)
N min.	$50$ (1.97)	$50$ (1.97)	$50$ (1.97)
W <sub>1</sub>	$12.4 + 2.0/-0.0$ (0.488 + 0.079/-0.0)	$12.4 + 2.0/-0.0$ (0.488 + 0.079/-0.0)	$12.4 + 2.0/-0.0$ (0.488 + 0.079/-0.0)
W <sub>2</sub> max.	$18.4$ (0.724)	$18.4$ (0.724)	$18.4$ (0.724)

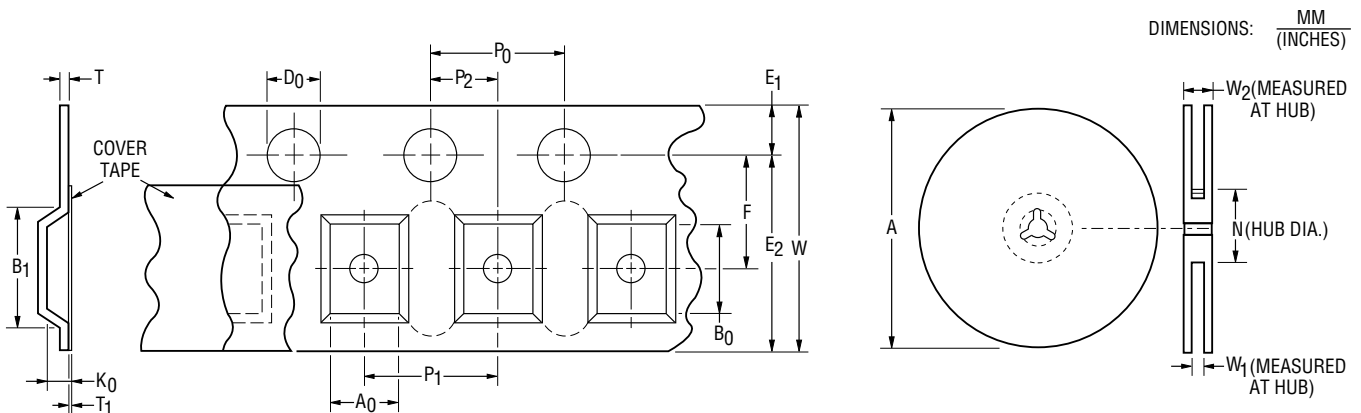

Specifications are subject to change without notice.  
 Users should verify actual device performance in their specific applications.  
 The device characteristics and parameters in this data sheet can and do vary in different applications and actual device performance may vary over time.