



MJE13005

NPN SILICON TRANSISTOR

NPN SILICON POWER TRANSISTORS

■ DESCRIPTION

These devices are designed for high-voltage, high-speed power switching inductive circuits where fall time is critical. They are particularly suited for 115 and 220 V SWITCHMODE.

■ FEATURES

- * $V_{CEO(SUS)} = 400\text{ V}$
- * Reverse bias SOA with inductive loads @ $T_C = 100$
- * Inductive switching matrix 2 to 4 Amp, 25 and 100 . . . tc @ 3A, 100 is 180 ns (Typ)
- * 700V blocking capability
- * SOA and switching applications information

■ APPLICATIONS

- * Switching regulator's, inverters
- * Motor controls
- * Solenoid/Relay drivers
- * Deflection circuits

■ ORDERING INFORMATION

Order Number		Package	Pin Assignment			Packing
Normal	Lead Free Plating		1	2	3	
MJE13005-TA3-T	MJE13005L-TA3-T	TO-220	B	C	E	Tube
MJE13005-TF3-T	MJE13005L-TF3-T	TO-220F	B	C	E	Tube

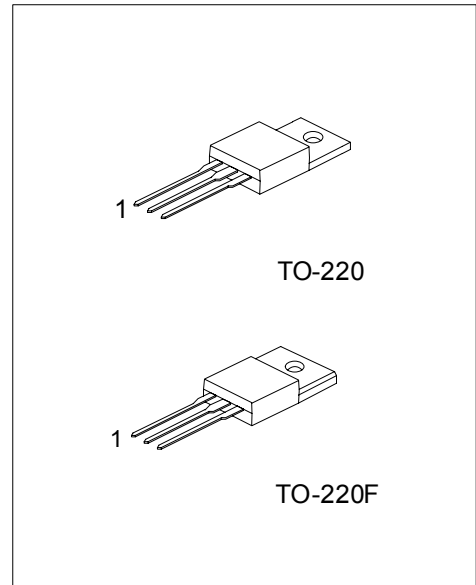

*Pb-free plating product number: MJE13005L

<p>MJE13005L-TA3-T</p> <p>(1)Packing Type</p> <p>(2)Package Type</p> <p>(3)Lead Plating</p>	<p>(1)T: Tube</p> <p>(2) TA3: TO-220, TF3: TO-220F</p> <p>(3) L: Lead Free Plating, Blank: Pb/Sn</p>
---	--

■ ABSOLUTE MAXIMUM RATINGS

PARAMETER		SYMBOL	RATINGS	UNIT
Collector-Emitter Voltage		$V_{CEO(SUS)}$	400	V
Collector-Emitter Voltage		V_{CBO}	700	V
Emitter Base Voltage		V_{EBO}	9	V
Collector Current	Continuous	I_C	4	A
	Peak (1)	I_{CM}	8	A
Base Current	Continuous	I_B	2	A
	Peak (1)	I_{BM}	4	A
Emitter Current	Continuous	I_E	6	A
	Peak (1)	I_{EM}	12	A
Total Power Dissipation at $T_a=25$ Derate above 25		P_D	2	W
			16	mW/
Total Power Dissipation at $T_c=25$ Derate above 25		P_D	75	W
			600	mW/
Operating and Storage Junction Temperature Range		T_J, T_{STG}	-65 ~ +150	

Note: Absolute maximum ratings are those values beyond which the device could be permanently damaged.
Absolute maximum ratings are stress ratings only and functional device operation is not implied.

■ THERMAL DATA

PARAMETER	SYMBOL	MAX	UNIT
Thermal Resistance, Junction to Ambient	θ_{JA}	62.5	/W
Thermal Resistance, Junction to Case	θ_{JC}	1.67	/W

(1) Pulse Test : Pulse Width=5ms,Duty Cycle≤10%

■ ELECTRICAL CHARACTERISTICS ($T_c=25$, unless otherwise specified)

PARAMETER	SYMBOL	TEST CONDITIONS	MIN	TYP	MAX	UNIT
*OFF CHARACTERISTICS (1)						
Collector-Emitter Sustaining Voltage	$V_{CEO(SUS)}$	$I_C=10mA, I_B=0$	400			V
Collector Cutoff Current	I_{CBO}	$V_{CBO}=\text{Rated Value}, V_{BE(OFF)}=1.5V$			1	mA
		$V_{CBO}=\text{Rated Value}, V_{BE(OFF)}=1.5V, T_c=100$			5	
Emitter Cutoff Current	I_{EBO}	$V_{EB}=9V, I_C=0$			1	mA
SECOND BREAKDOWN						
Second Breakdown Collector Current with base forward biased	$I_{s/b}$				See Figure 11	
Clamped Inductive SOA with Base Reverse Biased	RBSOA				See Figure 12	
*ON CHARACTERISTICS (1)						
DC Current Gain	h_{FE1}	$I_C=1A, V_{CE}=5V$	10		60	
	h_{FE2}	$I_C=2A, V_{CE}=5V$	8		40	
Collector-Emitter Saturation Voltage	$V_{CE(SAT)}$	$I_C=1A, I_B=0.2A$			0.5	V
		$I_C=2A, I_B=0.5A$			0.6	V
		$I_C=4A, I_B=1A$			1	V
		$I_C=2A, I_B=0.5A, T_a=100$			1	V
Base-Emitter Saturation Voltage	$V_{BE(SAT)}$	$I_C=1A, I_B=0.2A$			1.2	V
		$I_C=2A, I_B=0.5A$			1.6	V
		$I_C=2A, I_B=0.5A, T_c=100$			1.5	V
DYNAMIC CHARACTERISTICS						
Current-Gain-Bandwidth Product	f_T	$I_C=500mA, V_{CE}=10V, f=1MHz$	4			MHz
Output Capacitance	C_{ob}	$V_{CB}=10V, I_E=0, f=0.1MHz$		65		pF

ELECTRICAL CHARACTERISTICS (Cont.)

PARAMETER	SYMBOL	TEST CONDITIONS	MIN	TYP	MAX	UNIT
SWITCHING CHARACTERISTICS						
Resistive Load (Table 1)						
Delay Time	t_D	$V_{CC}=125V, I_C=2A, I_{B1}=I_{B2}=0.4A,$ $t_p=25\mu s, \text{Duty Cycle}\leq 1\%$		0.025	0.1	μs
Rise Time	t_R			0.3	0.7	μs
Storage Time	t_S			1.7	4	μs
Fall Time	t_F			0.4	0.9	μs

* Pulse Test: Pulse Width=300 μs , Duty Cycle $\leq 2\%$

Table 1. Test Conditions for Dynamic Performance

	REVERSE BIAS SAFE OPERATING AREA AND INDUCTIVE SWITCHING	RESISTIVE SWITCHING
TEST CIRCUITS	<p>NOTE Pw and Vcc Adjusted for Desired t Rb Adjusted for Desired Ib1</p>	
CIRCUIT VALUES	<p>Coil Data : FERROXCUBE core #6656 Full Bobbin (~ 16 Turns) #16</p> <p>GAP for 200 $\mu H/20 A$ Lcoil=200 μH</p> <p>$V_{CC}=20V$ $V_{clamp}=300V$</p>	<p>$V_{CC}=125V$ $R_C=62$ D1=1n5820 or Equiv. $R_B=22$</p>
TEST WAVEFORMS	<p>OUTPUT WAVEFORMS</p> <p>t_1 Adjusted to Obtain I_C</p> $t_1 = \frac{L_{coil}(I_{Cpk})}{V_{CC}}$ $t_2 = \frac{L_{coil}(I_{Cpk})}{V_{clamp}}$ <p>Test Equipment Scope-Tektronics 475 or Equivalent</p>	<p>$t_r, t_f < 10ns$ Duty Cycle=1.0% R_B and R_C adjusted for desired I_B and I_C</p>

RESISTIVE SWITCHING PERFORMANCE

Figure 1. Turn-On Time

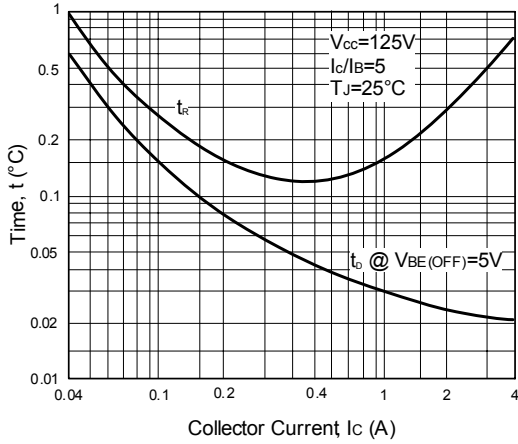

Figure 2. Turn-Off Time

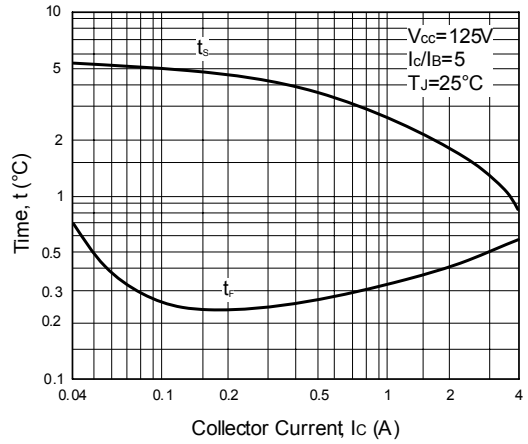

Figure 3. Typical Thermal Response [$Z_{JC}(t)$]

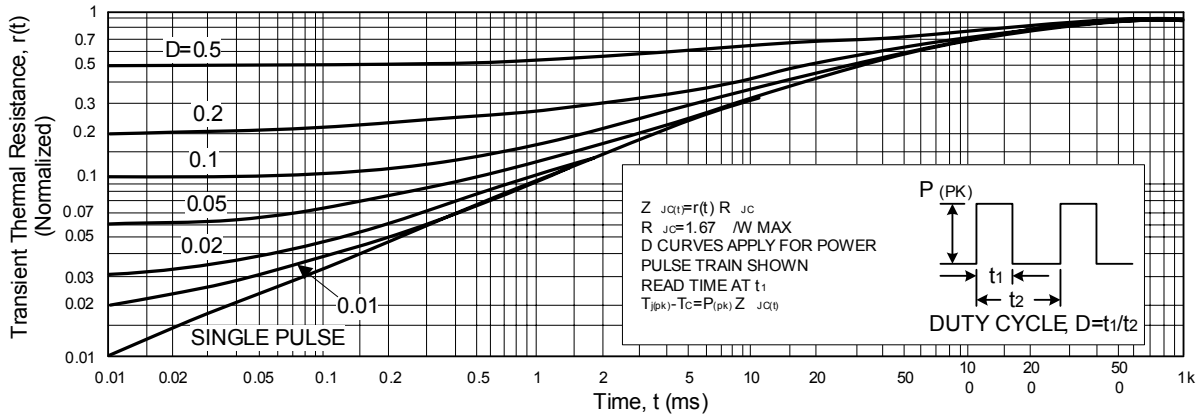

Figure 4. Forward Bias Safe Operating Area

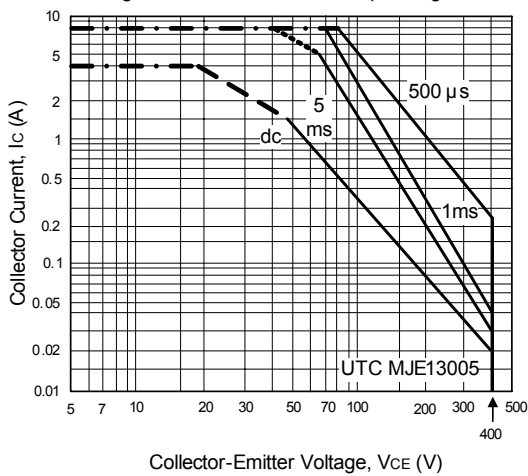
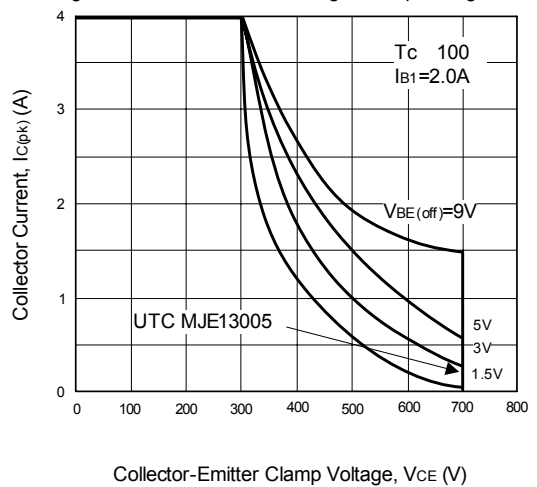
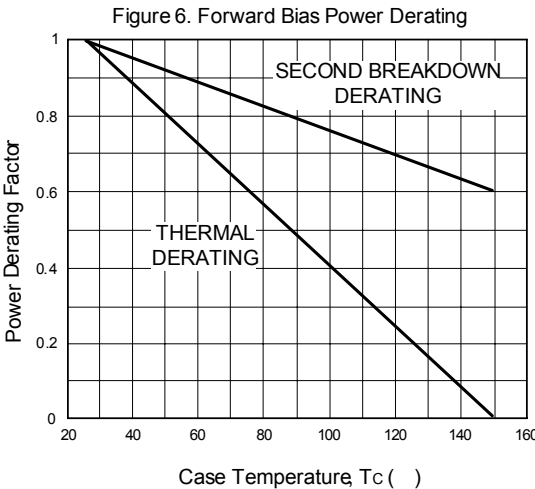

Figure 5. Reverse Bias Switching Safe Operating Area



■ RESISTIVE SWITCHING PERFORMANCE



■ SAFE OPERATING AREA INFORMATION

FORWARD BIAS

There are two limitations on the power handling ability of a transistor: average junction temperature and second breakdown. Safe operating area curves indicate I_C - V_{CE} limits of the transistor that must be observed for reliable operation; e., the transistor must not be subjected to greater dissipation than the curves indicate.

The data of Figure 4 is based on $T_C = 25^\circ\text{C}$; $T_J(\text{pk})$ is variable depending on power level. Second breakdown pulse limits are valid for duty cycles to 10% but must be derated when $T_C \geq 25^\circ\text{C}$. Second breakdown limitations do not derate the same as thermal limitations. Allowable current at the voltages shown on Figure 4 may be found at any case temperature by using the appropriate curve on Figure 6.

$T_J(\text{pk})$ may be calculated from the data in Figure 10. At high case temperatures, thermal limitations will reduce the power that can be handled to values less than the limitations imposed by second breakdown.

REVERSE BIAS

For inductive loads, high voltage and high current must be sustained simultaneously during turn-off, in most cases, with the base to emitter junction reverse biased. Under these conditions the collector voltage must be held to a safe level at or below a specific value of collector current. This can be accomplished by several means such as active clamping, RC snubbing, load line shaping, etc. The safe level for these devices is specified as Reverse Bias Safe Operating Area and represents the voltage-current conditions during reverse biased turn-off. This rating is verified under clamped conditions so that the device is never subjected to an avalanche mode. Figure 5 gives the complete RBSOA characteristics.

TYPICAL CHARACTERISTICS

Figure 7. DC Current Gain

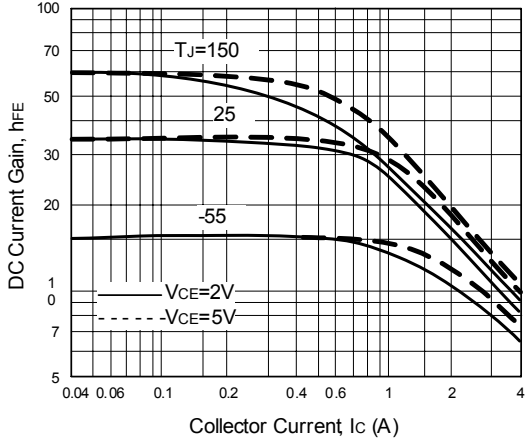

Figure 8. Collector Saturation Region

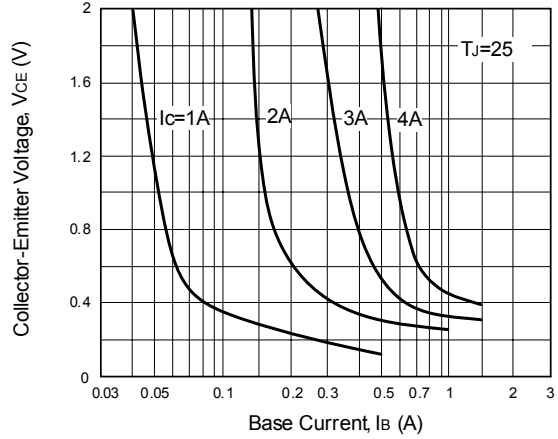

Figure 9. Base-Emitter Voltage

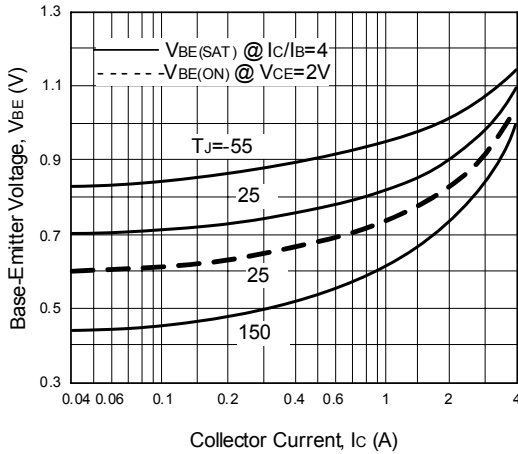

Figure 10. Collector-Emitter Saturation Voltage

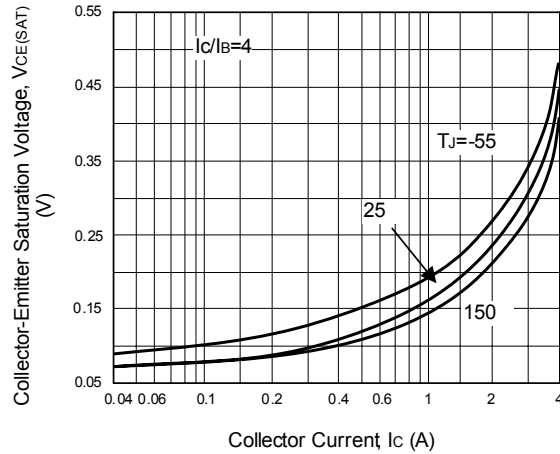

Figure 11. Collector Cutoff Region

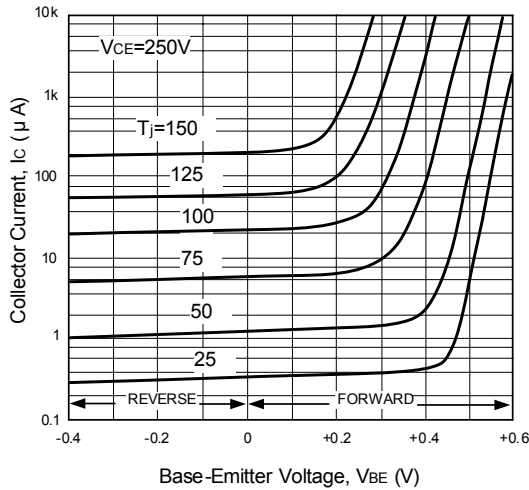
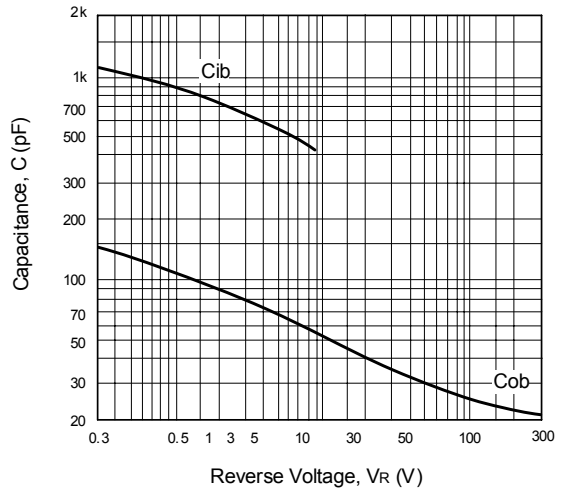

Figure 12. Capacitance



UTC assumes no responsibility for equipment failures that result from using products at values that exceed, even momentarily, rated values (such as maximum ratings, operating condition ranges, or other parameters) listed in products specifications of any and all UTC products described or contained herein. UTC products are not designed for use in life support appliances, devices or systems where malfunction of these products can be reasonably expected to result in personal injury. Reproduction in whole or in part is prohibited without the prior written consent of the copyright owner. The information presented in this document does not form part of any quotation or contract, is believed to be accurate and reliable and may be changed without notice.