



MMBT222A-AU

NPN GENERAL PURPOSE SWITCHING TRANSISTOR

VOLTAGE 40 Volts **POWER** 225 mWatts

SOT-23 Unit : inch(mm)

FEATURES

- NPN epitaxial silicon, planar design
- Collector-emitter voltage $V_{CE} = 40V$
- Collector current $I_C = 600mA$
- Acquire quality system certificate : TS16949
- AEC-Q101 qualified
- Lead free in comply with EU RoHS 2002/95/EC directives.
- Green molding compound as per IEC61249 Std. . (Halogen Free)

MECHANICAL DATA

- Case: SOT-23, Plastic
- Terminals: Solderable per MIL-STD-750, Method 2026
- Approx. Weight: 0.0003 ounces, 0.0084 grams
- Marking: M2A

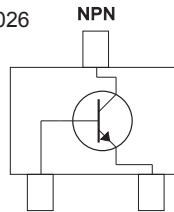
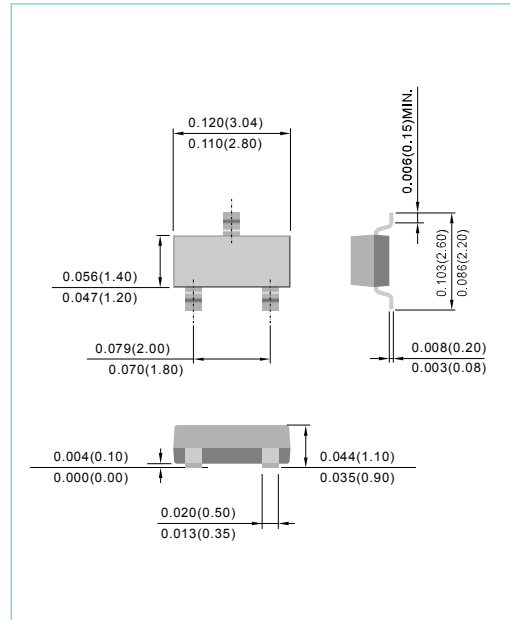

Fig.34



ABSOLUTE RATINGS

PARAMETER	Symbol	Value	Units
Collector - Emitter Voltage	V_{CEO}	40	V
Collector - Base Voltage	V_{CBO}	75	V
Emitter - Base Voltage	V_{EBO}	6.0	V
Collector Current - Continuous	I_C	600	mA

THERMAL CHARACTERISTICS

PARAMETER	Symbol	Value	Units
Max Power Dissipation (Note 1)	P_{TOT}	225	mW
Thermal Resistance , Junction to Ambient	$R_{\theta JA}$	556	$^{\circ}C/W$
Junction Temperature	T_J	-55 to 150	$^{\circ}C$
Storage Temperature	T_{STG}	-55 to 150	$^{\circ}C$

Note 1: Transistor mounted on FR-5 board 1.0 x 0.75 x 0.062 in.



MMBT222A-AU

PARAMETER	Symbol	Test Condition	MIN.	TYP.	MAX.	Units
Collector - Emitter Breakdown Voltage	$V_{(BR)CEO}$	$I_C=1.0mA, I_B=0$	40	-	-	V
Collector - Base Breakdown Voltage	$V_{(BR)CBO}$	$I_C=10\mu A, I_E=0$	75	-	-	V
Emitter - Base Breakdown Voltage	$V_{(BR)EBO}$	$I_E=10\mu A, I_C=0$	6.0	-	-	V
Base Cutoff Current	I_{BL}	$V_{CE}=60V, V_{EB}=3.0V$	-	-	20	nA
Collector Cutoff Current	I_{CEX}	$V_{CE}=60V, V_{EB}=3.0V$	-	-	10	nA
	I_{CBO}	$V_{CE}=60V, I_E=0, V_{EB}=60V, I_E=0, T_J=125^\circ C$	-	-	10 10	nA μA
Emitter Cutoff Current	I_{EBO}	$V_{EB}=3.0V, I_C=0,$	-	-	100	nA
DC Current Gain	h_{FE}	$I_C=0.1mA, V_{CE}=10V$	35	-	-	-
		$I_C=1.0mA, V_{CE}=10V$	50	-	-	
		$I_C=10mA, V_{CE}=10V$	75	-	-	
		$I_C=10mA, V_{CE}=10V, T_J=125^\circ C$	35	-	-	
		$I_C=150mA, V_{CE}=10V$ (Note 2)	100	-	300	
		$I_C=150mA, V_{CE}=1V$ (Note 2)	50	-	-	
Collector - Emitter Saturation Voltage (Note 2)	$V_{CE(SAT)}$	$I_C=150mA, I_B=15mA$	-	-	0.3	V
		$I_C=500mA, I_B=50mA$	-	-	1.0	
Base - Emitter Saturation Voltage (Note 2)	$V_{BE(SAT)}$	$I_C=150mA, I_B=15mA$	0.6	-	1.2	V
		$I_C=500mA, I_B=50mA$	-	-	2.0	
Collector - Base Capacitance	C_{CBO}	$V_{CB}=10V, I_E=0, f=1MHz$	-	-	8.0	pF
Emitter - Base Capacitance	C_{EBO}	$V_{CB}=0.5V, I_C=0, f=1MHz$	-	-	25	pF
Delay Time	t_d	$V_{CC}=3V, V_{BE}=-5V, I_C=150mA, I_B=15mA$	-	-	10	ns
Rise Time	t_r	$V_{CC}=3V, V_{BE}=-5V, I_C=150mA, I_B=15mA$	-	-	25	ns
Storage Time	t_s	$V_{CC}=30V, I_C=150mA, I_B1=I_B2=15mA$	-	-	225	ns
Fall Time	t_f	$V_{CC}=30V, I_C=150mA, I_B1=I_B2=15mA$	-	-	60	ns

Note 2: Pulse Test: Pulse Width < 300 us, Duty Cycle < 2.0%.

SWITCHING TIME EQUIVALENT TEST CIRCUITS

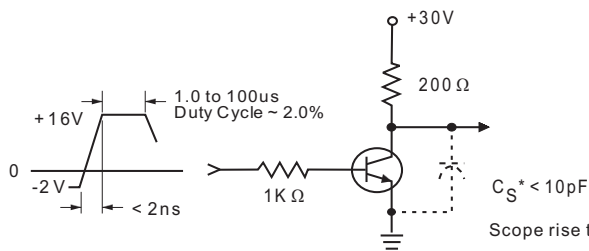

Fig. 1 Turn-On Time

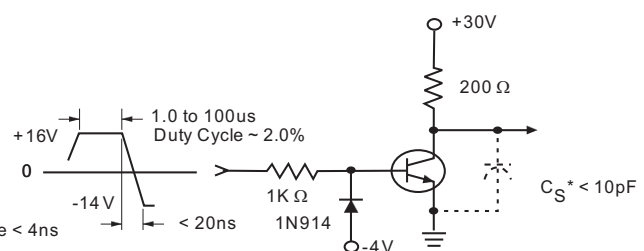

Fig. 2 Turn-Off Time

* Total shunt capacitance of test jig, connectors, and oscilloscope



MMBT222A-AU

ELECTRICAL CHARACTERISTICS CURVE

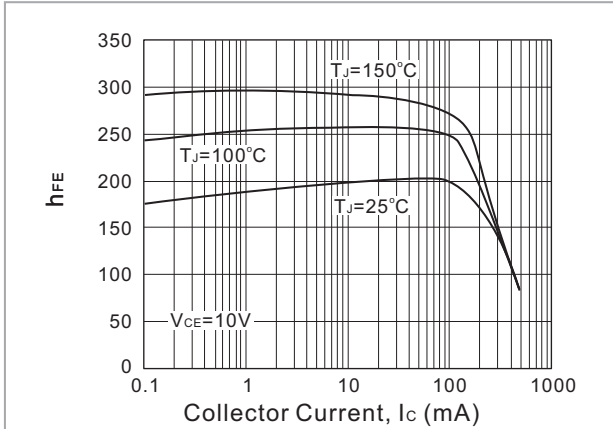

Fig. 3. Typical h_{FE} vs Collector Current

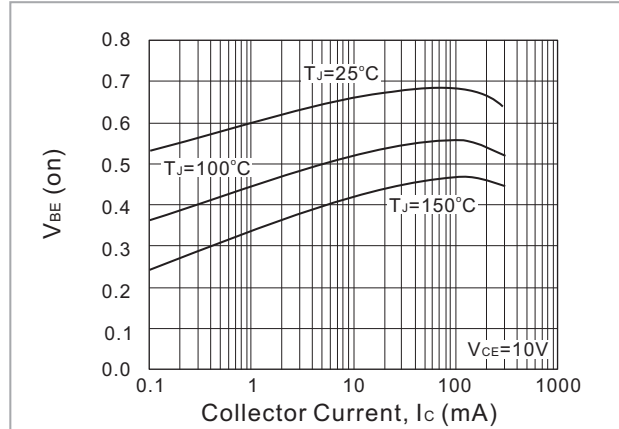

Fig. 4. Typical V_{BE} vs Collector Current

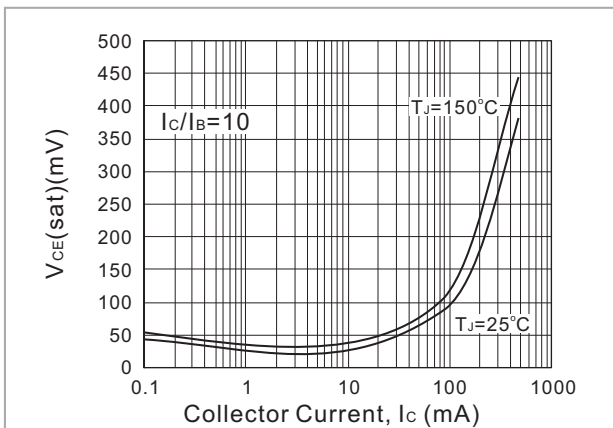

Fig. 5. Typical $V_{CE(sat)}$ vs Collector Current

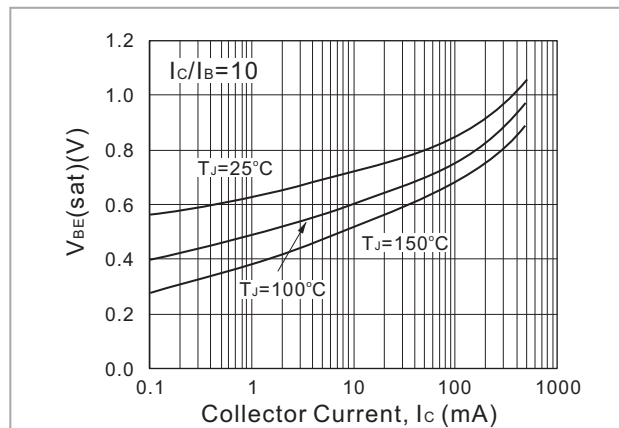

Fig. 6. Typical $V_{BE(sat)}$ vs Collector Current

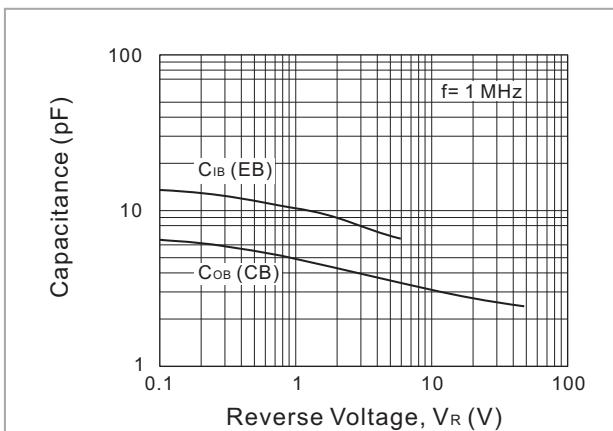
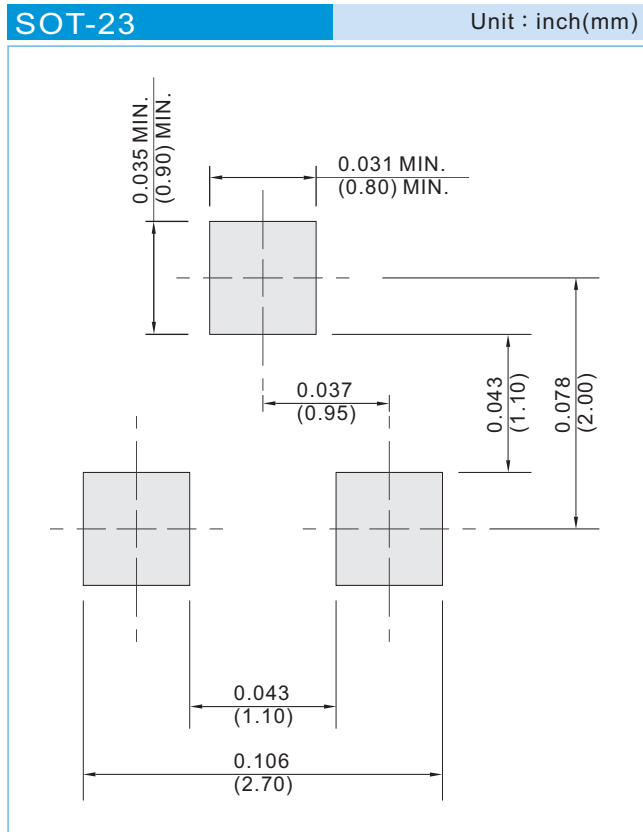

Fig. 7. Typical Capacitances vs Reverse Voltage



MMBT2222A-AU

MOUNTING PAD LAYOUT



ORDER INFORMATION

- Packing information
 - T/R - 12K per 13" plastic Reel
 - T/R - 3K per 7" plastic Reel



MMBT222A-AU

Part No_packing code_Version

MMBT222A-AU_R1_000A1

MMBT222A-AU_R2_000A1

For example :

RB500V-40_R2_00001



Packing Code XX				Version Code XXXXX		
Packing type	1 st Code	Packing size code	2 nd Code	HF or RoHS	1 st Code	2 nd ~5 th Code
Tape and Ammunition Box (T/B)	A	N/A	0	HF	0	serial number
Tape and Reel (T/R)	R	7"	1	RoHS	1	serial number
Bulk Packing (B/P)	B	13"	2			
Tube Packing (T/P)	T	26mm	X			
Tape and Reel (Right Oriented) (TRR)	S	52mm	Y			
Tape and Reel (Left Oriented) (TRL)	L	PANASERT T/B CATHODE UP (PBCU)	U			
FORMING	F	PANASERT T/B CATHODE DOWN (PBCD)	D			



MMBT2222A-AU

Disclaimer

- Reproducing and modifying information of the document is prohibited without permission from Panjit International Inc..
- Panjit International Inc. reserves the rights to make changes of the content herein the document anytime without notification. Please refer to our website for the latest document.
- Panjit International Inc. disclaims any and all liability arising out of the application or use of any product including damages incidentally and consequentially occurred.
- Panjit International Inc. does not assume any and all implied warranties, including warranties of fitness for particular purpose, non-infringement and merchantability.
- Applications shown on the herein document are examples of standard use and operation. Customers are responsible in comprehending the suitable use in particular applications. Panjit International Inc. makes no representation or warranty that such applications will be suitable for the specified use without further testing or modification.
- The products shown herein are not designed and authorized for equipments requiring high level of reliability or relating to human life and for any applications concerning life-saving or life-sustaining, such as medical instruments, transportation equipment, aerospace machinery et cetera. Customers using or selling these products for use in such applications do so at their own risk and agree to fully indemnify Panjit International Inc. for any damages resulting from such improper use or sale.