

# PV7 Series



Illuminated



Water Protection



1 TON Heavy Duty



Front Panel Mount

RoHS

NEW

## Suggested Panel Cutout

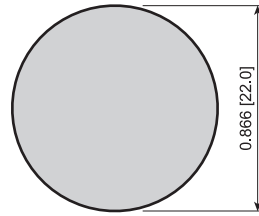

Maximum Panel Thickness:  
Momentary Version: 0.315 [8,0mm]  
Maintained Version: 0.472 [12,0mm]

## FEATURES:

- Vandal and Water Resistant
- Long Life Expectancy

## SPECIFICATIONS:

**RATING:** 2A 48VDC  
**ILLUMINATION BASE RATING:**  
 Red, Yellow, and Orange: 20mA 1.8V  
 Blue, Green, and White: 20mA 2.8V  
**TEMPERATURE:** -20°C to 70°C  
**CONTACT RESISTANCE:** 50mΩ Max.  
**INSULATION RESISTANCE:** 1,000MΩ Min.  
**DIELECTRIC STRENGTH:** 2,000VAC  
**MECHANICAL LIFE:** 1,000,000 Cycles  
**ELECTRICAL LIFE:** 50,000 Cycles

## MATERIALS:

**BUTTON:** Stainless Steel  
 Nickel Plated Brass  
**BODY:** Stainless Steel  
 Nickel Plated Brass  
**BASE:** PBT

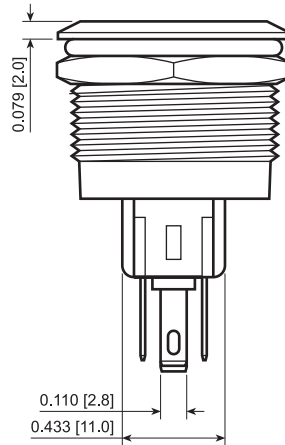
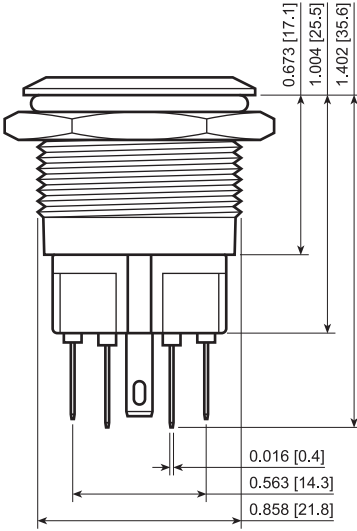
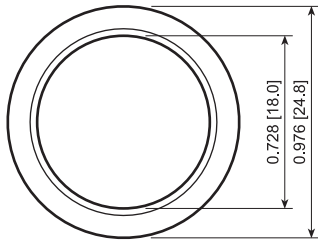

## Illumination Options

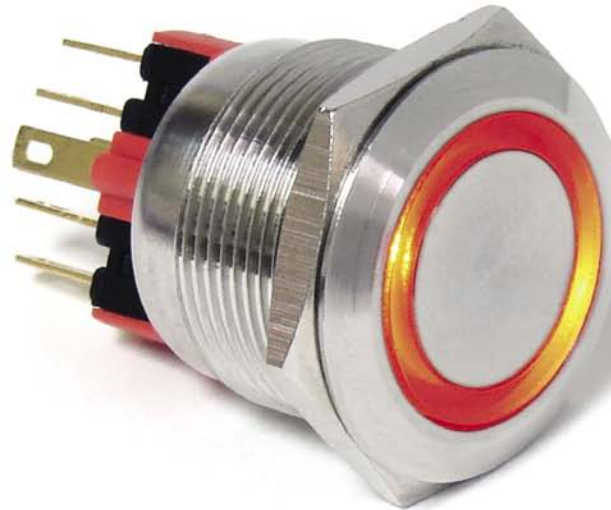
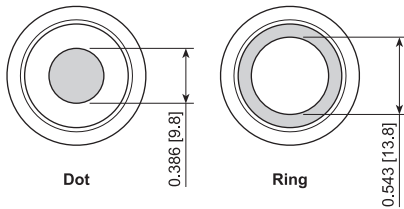

PV7F2Y0SS-311

## Maintained Version Dimensions

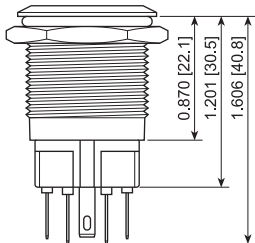

SPECIFICATIONS SUBJECT TO CHANGE WITHOUT NOTICE

Series	Actuator Options	Terminal	Function	Rating	Body Finish	Actuator Finish	Contact Material	Lens Style	Lens Color	Illumination Voltage
PV7	F - Flat	2 - Solder	2 Pole: Y - 1P Off-(On) / 1P On-(Off) T - 1P Off-On / 1P On-Off	0 - 2A 48VDC	N - Nickel S - Stainless Steel	N - Nickel S - Stainless Steel	None - Silver G - Gold	2 - Dot 3 - Ring	0 - White 1 - Red 2 - Orange 3 - Green 4 - Blue 5 - Yellow	1 - Base Voltage 3 - 6V 4 - 12V 5 - 24V 6 - 125V 7 - 250V

Notes:  
Additional material, illumination and marking options are available. Please ask your sales person.

For Illuminated Switches Only

## EXAMPLE PART NUMBERS:

- PV7F2T0SS-344 1P Off-On/1P On-Off  
Flat Actuator, Blue Ring Illumination, 12V
- PV7F2Y0SS 1P Off-(On)/1P On-(Off)  
Flat Actuator
- PV7F2Y0SS-241 1P Off-(On)/1P On-(Off)  
Flat Actuator, Blue Dot Illumination, 2.8V
- PV7F2Y0SS-313 1P Off-(On)/1P On-(Off)  
Flat Actuator, Red Ring Illumination, 6V
- PV7F2Y0SS-351 1P Off-(On)/1P On-(Off)  
Flat Actuator, Yellow Ring Illumination, 1.8V



ANTI-VANDAL