

### Description

The 2920L Series PTC provides surface mount overcurrent protection for medium voltage ( $\leq 60V$ ) applications where resettable protection is desired.



### Features

- RoHS compliant, lead-free and halogen-free
- High voltage
- Fast response to fault currents
- Low-profile



### Applications

- IEE1394 port protection
- Powered ethernet port protection (IEEE 802.3 af)
- Automotive electronic control module protection
- Low voltage telecom equipment protection

### Agency Approvals

AGENCY	AGENCY FILE NUMBER
	E183209
	R50119118

### Electrical Characteristics

Part Number	Marking	$I_{hold}$ (A)	$I_{trip}$ (A)	$V_{max}$ (Vdc)	$I_{max}$ (A)	$P_d$ max. (W)	Maximum Time To Trip		Resistance			Agency Approvals	
							Current (A)	Time (Sec.)	$R_{min}$ ( $\Omega$ )	$R_{typ}$ ( $\Omega$ )	$R_{1max}$ ( $\Omega$ )		
2920L030	LF030	0.30	0.60	60	10	1.50	1.50	3.00	1.200	3.000	4.800	X	X
2920L050	LF050	0.50	1.00	60	10	1.50	2.50	4.00	0.350	0.870	1.400	X	X
2920L075	LF075	0.75	1.50	30	40	1.50	8.00	0.30	0.350	0.670	1.000	X	X
2920L075/60	LF075-60	0.75	1.50	60	10	1.50	8.00	0.30	0.300	0.60	0.950	X	X
2920L100	LF100	1.10	2.20	33	40	1.50	8.00	0.50	0.120	0.270	0.410	X	X
2920L125	LF125	1.25	2.50	15	40	1.50	8.00	2.00	0.070	0.160	0.250	X	X
2920L150	LF150	1.50	3.00	33	40	1.50	8.00	2.00	0.080	0.150	0.230	X	X
2920L185	LF185	1.85	3.70	33	40	1.50	8.00	2.50	0.065	0.110	0.150	X	X
2920L200	LF200	2.00	4.00	15	40	1.50	8.00	5.00	0.050	0.090	0.125	X	X
2920L200/24	LF200-24	2.00	4.00	24	40	1.50	8.00	5.00	0.050	0.090	0.125	X	X
2920L250	LF250	2.50	5.00	15	40	1.50	8.00	10.00	0.035	0.060	0.085	X	X
2920L260	LF260	2.60	5.00	6	40	1.50	8.00	10.00	0.025	0.050	0.075	X	X
2920L300	LF300	3.00	5.00	6	40	1.50	8.00	20.00	0.015	0.033	0.048	X	X
2920L300/15	LF300-15	3.00	5.00	15	40	1.50	8.00	20.00	0.015	0.033	0.048	X	X

$I_{hold}$  = Hold current: maximum current device will pass without tripping in 20°C still air.

$I_{trip}$  = Trip current: minimum current at which the device will trip in 20°C still air.

$V_{max}$  = Maximum voltage device can withstand without damage at rated current ( $I_{max}$ )

$I_{max}$  = Maximum fault current device can withstand without damage at rated voltage ( $V_{max}$ )

$P_d$  = Power dissipated from device when in the tripped state at 20°C still air.

$R_{min}$  = Minimum resistance of device in initial (un-soldered) state.

$R_{typ}$  = Typical resistance of device in initial (un-soldered) state.

$R_{1max}$  = Maximum resistance of device at 20°C measured one hour after tripping or reflow soldering of 260°C for 20 sec.

**Caution:** Operation beyond the specified rating may result in damage and possible arcing and flame.

Effective September 15, 2009 onward, all 2920L PTC products will be manufactured Halogen Free (HF). Existing Non-Halogen Free 2920L PTC products will continue to be sold until supplies are depleted. Effective January 1, 2010, all 2920L PTC product will be manufactured and sold as Halogen Free by default, and the "HF" part number suffix code will be discontinued – Refer to Part Ordering Number System and Packaging Options sections for additional information.

**Temperature Derating**

Part Number	Ambient Operation Temperature								
	-40°C	-20°C	0°C	23°C	40°C	50°C	60°C	70°C	85°C
2920L030	0.45	0.40	0.35	0.30	0.25	0.23	0.20	0.17	0.14
2920L050	0.76	0.67	0.59	0.50	0.42	0.38	0.33	0.29	0.23
2920L075	1.13	1.01	0.88	0.75	0.62	0.56	0.50	0.44	0.34
2920L075/60	1.13	1.01	0.88	0.75	0.62	0.56	0.50	0.44	0.34
2920L100	1.66	1.47	1.29	1.10	0.91	0.83	0.73	0.64	0.50
2920L125	1.89	1.68	1.46	1.25	1.04	0.94	0.83	0.73	0.56
2920L150	2.27	2.01	1.76	1.50	1.25	1.13	1.00	0.87	0.74
2920L185	2.80	2.47	2.17	1.85	1.54	1.39	1.22	1.07	0.85
2920L200	3.02	2.68	2.34	2.00	1.66	1.50	1.32	1.16	0.90
2920L200/24	3.14	2.77	2.42	2.00	1.73	1.56	1.38	1.20	0.98
2920L250	3.78	3.35	2.93	2.50	2.08	1.88	1.65	1.45	1.13
2920L260	3.64	3.25	2.91	2.60	2.26	2.08	1.95	1.74	1.48
2920L300	4.53	4.02	3.51	3.00	2.52	2.26	1.99	1.75	1.34
2920L300/15	4.20	3.85	3.44	3.00	2.69	2.50	2.31	2.12	1.83

**Average Time Current Curves**

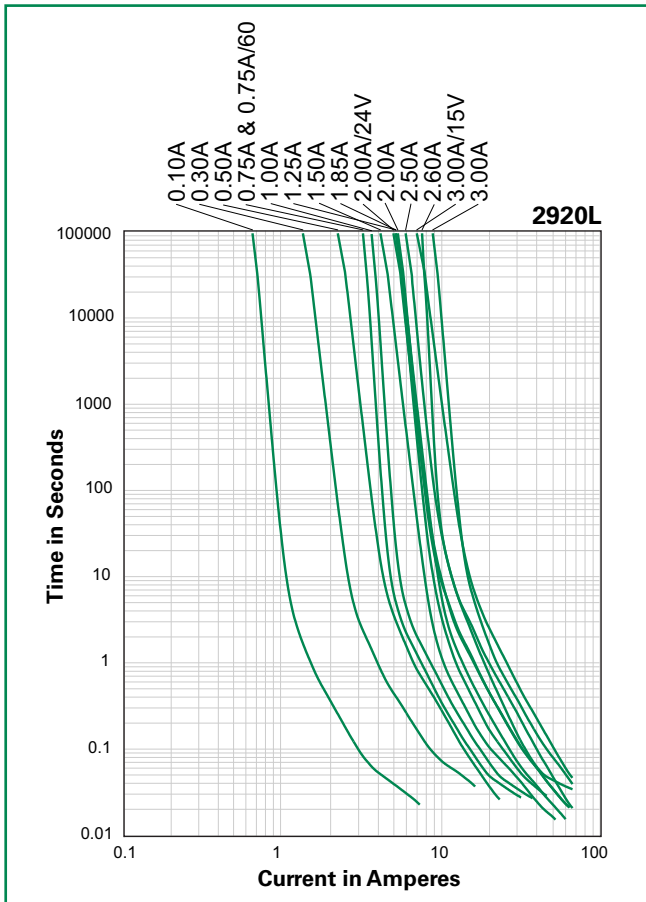

**Temperature Derating Curve**

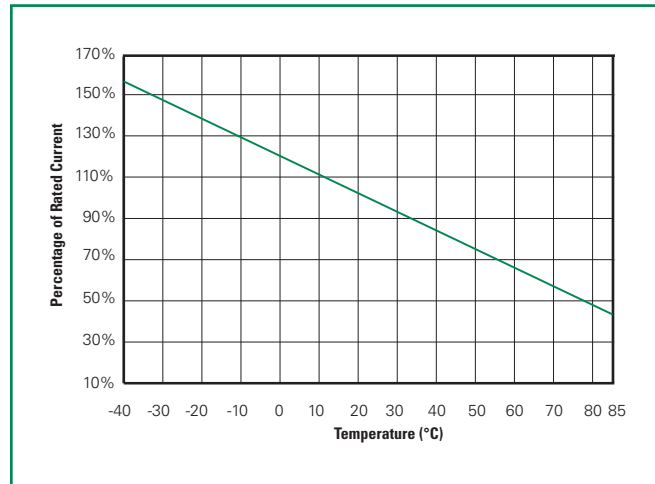

The average time current curves and Temperature Derating curve performance is affected by a number of variables, and these curves provided as guidance only. Customer must verify the performance in their application.

### Soldering Parameters

Condition	Reflow
Peak Temp/ Duration Time	260°C / 10 Sec
Time above liquids (TAL) 220°C	60 Sec ~ 100 Sec
Preheat 120°C~ 180°C	50 Sec ~ 150 Sec
Storage Condition	0°C~35°C, ≤70%RH

- Recommended reflow methods: IR, vapor phase oven, hot air oven, N<sub>2</sub> environment for lead-free
- Recommended maximum paste thickness is 0.25mm (0.010 inch)
- Devices can be cleaned using standard industry methods and solvents.

**Note:** If reflow temperatures exceed the recommended profile, devices may not meet the performance requirements.

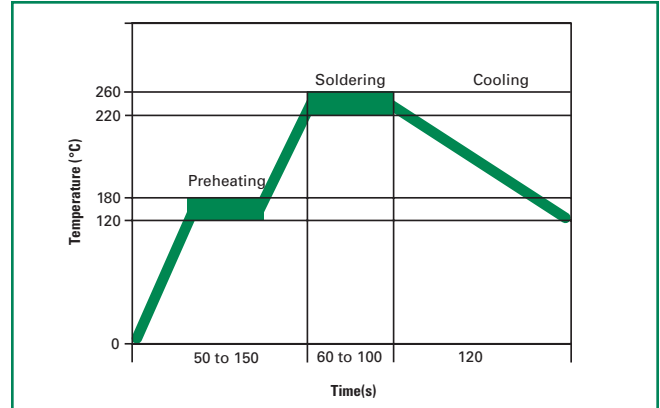

### Physical Specifications

<b>Terminal Material</b>	Solder-Plated Copper (Solder Material: Matte Tin(Sn))
<b>Lead Solderability</b>	Meets EIA Specification RS186-9E, ANSI/J-STD-002 Category 3.

### Environmental Specifications

<b>Operating/Storage Temperature</b>	-40°C to +85°C
<b>Maximum Device Surface Temperature in Tripped State</b>	125°C
<b>Passive Aging</b>	+85°C, 1000 hours -/+5% typical resistance change
<b>Humidity Aging</b>	+85°C, 85%, R.H., 1000 hours -/+5% typical resistance change
<b>Thermal Shock</b>	MIL-STD-20 2, Method 107G +85°C/-40°C 20 times -30% typical resistance change
<b>Solvent Resistance</b>	MIL-STD-202, Method 215
<b>Vibration</b>	MIL-STD-883C, Method 2007.1, Condition A
<b>Moisture Sensitivity Level</b>	Level 1, J-STD-020C

**Dimensions (mm)**

MARKING CODE VARIES  
WITH AMPERAGE AND VOLTAGE RATING  
(SEE ELECTRICAL CHARACTERISTIC TABLE)  
SHOWN ARE:  
- 1.5A/33V RATING (LEFT)  
- 2.0A/24V RATING (RIGHT)

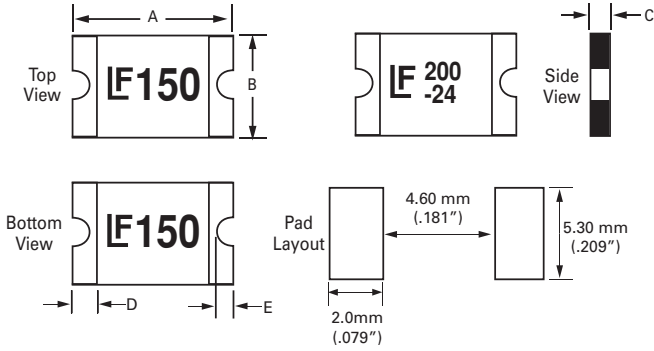

Part Number	A				B				C				D				E			
	Inches		mm		Inches		mm		Inches		mm		Inches		mm		Inches		mm	
	Min	Max	Min	Max	Min	Max	Min	Max	Min	Max	Min	Max	Min	Max	Min	Max	Min	Max	Min	Max
2920L030	0.26	0.31	6.73	7.98	0.19	0.21	4.8	5.44	0.03	0.05	0.75	1.25	0.01	0.1	0.3	2.5	0.01	0.08	0.25	2
2920L050	0.26	0.31	6.73	7.98	0.19	0.21	4.8	5.44	0.03	0.05	0.75	1.25	0.01	0.1	0.3	2.5	0.01	0.08	0.25	2
2920L075	0.26	0.31	6.73	7.98	0.19	0.21	4.8	5.44	0.03	0.05	0.75	1.25	0.01	0.1	0.3	2.5	0.01	0.08	0.25	2
2920L075/60	0.26	0.31	6.73	7.98	0.19	0.21	4.8	5.44	0.05	0.06	1.20	1.80	0.01	0.1	0.3	2.5	0.01	0.08	0.25	2
2920L100	0.26	0.31	6.73	7.98	0.19	0.21	4.8	5.44	0.02	0.04	0.55	1	0.01	0.1	0.3	2.5	0.01	0.08	0.25	2
2920L125	0.26	0.31	6.73	7.98	0.19	0.21	4.8	5.44	0.02	0.04	0.55	1	0.01	0.1	0.3	2.5	0.01	0.08	0.25	2
2920L150	0.26	0.31	6.73	7.98	0.19	0.21	4.8	5.44	0.03	0.05	0.75	1.25	0.01	0.1	0.3	2.5	0.01	0.08	0.25	2
2920L185	0.26	0.31	6.73	7.98	0.19	0.21	4.8	5.44	0.03	0.05	0.75	1.25	0.01	0.1	0.3	2.5	0.01	0.08	0.25	2
2920L200	0.26	0.31	6.73	7.98	0.19	0.21	4.8	5.44	0.03	0.05	0.75	1.25	0.01	0.1	0.3	2.5	0.01	0.08	0.25	2
2920L200/24	0.26	0.31	6.73	7.98	0.19	0.21	4.8	5.44	0.03	0.05	0.75	1.25	0.01	0.1	0.3	2.5	0.01	0.08	0.25	2
2920L250	0.26	0.31	6.73	7.98	0.19	0.21	4.8	5.44	0.03	0.05	0.75	1.25	0.01	0.1	0.3	2.5	0.01	0.08	0.25	2
2920L260	0.26	0.31	6.73	7.98	0.19	0.21	4.8	5.44	0.02	0.04	0.55	1	0.01	0.1	0.3	2.5	0.01	0.08	0.25	2
2920L300	0.26	0.31	6.73	7.98	0.19	0.21	4.8	5.44	0.03	0.05	0.75	1.25	0.01	0.1	0.3	2.5	0.01	0.08	0.25	2
2920L300/15	0.26	0.31	6.73	7.98	0.19	0.21	4.8	5.44	0.03	0.05	0.75	1.25	0.01	0.1	0.3	2.5	0.01	0.08	0.25	2

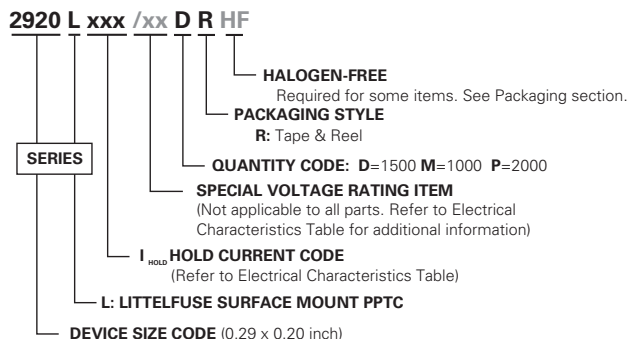
**Part Ordering Number System**

**Packaging**

Part Number	Ordering Number	Halogen Free	I <sub>hold</sub> (A)	I <sub>hold</sub> Code	Voltage Option	Packaging Option	Quantity	Quantity & Packaging Codes
2920L030	2920L030DRHF	Yes	0.30	030		Tape and Reel	1500	DR
	2920L030DR	No						
2920L050	2920L050DRHF	Yes	0.50	050		Tape and Reel	1500	DR
	2920L050DR	No						
2920L075	2920L075DRHF	Yes	0.75	075		Tape and Reel	1500	DR
	2920L075DR	No						
2920L075/60	2920L075/60MRHF	Yes	0.75	075	/60	Tape and Reel	1000	MR
	2920L075/60MR	No						
2920L100	2920L100PRHF	Yes	1.10	100		Tape and Reel	2000	PR
	2920L100PR	No						
2920L125	2920L125PRHF	Yes	1.25	125		Tape and Reel	2000	PR
	2920L125PR	No						
2920L150	2920L150DRHF	Yes	1.50	150		Tape and Reel	1500	DR
	2920L150DR	No						
2920L185	2920L185DRHF	Yes	1.85	185		Tape and Reel	1500	DR
	2920L185DR	No						
2920L200	2920L200DRHF	Yes	2.00	200		Tape and Reel	1500	DR
	2920L200DR	No						
2920L200/24	2920L200/24DRHF	Yes	2.00	200	/24	Tape and Reel	1500	DR
	2920L200/24DR	No						
2920L250	2920L250DRHF	Yes	2.50	250		Tape and Reel	1500	DR
	2920L250DR	No						
2920L260	2920L260PRHF	Yes	2.60	260		Tape and Reel	2000	PR
	2920L260PR	No						
2920L300	2920L300DRHF	Yes	3.00	300		Tape and Reel	1500	DR
	2920L300DR	No						
2920L300/15	2920L300/15DRHF	Yes	3.00	300	/15	Tape and Reel	1500	DR
	2920L300/15DR	No						

\* Effective September 15, 2009 onward, all 2920L PTC products will be manufactured Halogen Free (HF). Existing Non-Halogen Free 2920L PTC products will continue to be sold until supplies are depleted. Effective January 1, 2010, all 2920L PTC product will be manufactured and sold as Halogen Free by default, and "HF" part number suffix code will be discontinued.

**Tape and Reel Specifications**

TAPE SPECIFICATIONS: EIA-481-1 (mm)				
	2920L030, 2920L050, 2920L075	2920L100, 2920L125, 2920L260	2920L150, 2920L185, 2920L200, 2920L250, 2920L200/24, 2920L300, 2920L300/15	2920L075/60
<b>W</b>	16.0+/-0.30	16.0+/-0.30	16.0+/-0.30	16.0+/-0.30
<b>F</b>	7.5+/-0.05	7.5+/-0.05	7.5+/-0.05	7.5+/-0.10
<b>E<sub>1</sub></b>	1.75+/-0.10	1.75+/-0.10	1.75+/-0.10	1.75+/-0.10
<b>D<sub>0</sub></b>	1.55+/-0.05	1.55+/-0.05	1.55+/-0.05	1.50+/-0.10
<b>D<sub>1</sub></b>	1.5+/-0.10	1.5+/-0.10	1.5+/-0.10	1.5 (min)
<b>P<sub>0</sub></b>	4.0+/-0.10	4.0+/-0.10	4.0+/-0.10	4.0+/-0.10
<b>P<sub>1</sub></b>	8.0+/-0.10	8.0+/-0.10	8.0+/-0.10	8.0+/-0.10
<b>P<sub>2</sub></b>	2.0+/-0.05	2.0+/-0.05	2.0+/-0.05	2.0+/-0.10
<b>A<sub>0</sub></b>	5.45+/-0.10	5.45+/-0.10	5.45+/-0.10	5.45+/-0.10
<b>B<sub>0</sub></b>	7.65+/-0.10	7.65+/-0.10	7.65+/-0.10	7.90+/-0.10
<b>T</b>	0.25+/-0.10	0.25+/-0.10	0.25+/-0.10	0.30+/-0.05
<b>K<sub>0</sub></b>	1.25+/-0.10	1.00+/-0.10	1.45+/-0.10	2.00+/-0.10
<i>Leader min.</i>	390	390	390	390
<i>Trailer min.</i>	160	160	160	160

REEL DIMENSIONS: EIA-481-1 (mm)	
<b>H</b>	16.0+/-0.2
<b>W</b>	13.2+/-1.5
<b>D</b>	Ø 60.2+/-0.5
<b>F</b>	Ø 13.0+/-0.5
<b>C</b>	Ø 178+/-1.0
<b>H<sub>1</sub></b>	11+/-0.5
<b>W<sub>1</sub></b>	2.5+0.5
<b>W<sub>2</sub></b>	3.0+0.5
<b>W<sub>3</sub></b>	4.0+0.5

**Tape and Reel Diagram**

