

HIGH RIPPLE-REJECTION WLP PACKAGE LOW DROPOUT CMOS VOLTAGE REGULATOR

S-L2985 Series

The S-L2985 Series is a positive voltage regulator with a low dropout voltage, high output voltage accuracy, and low current consumption developed based on CMOS technology.

A built-in low on-resistance transistor provides a low dropout voltage and large output current, and a built-in overcurrent protector prevents the load current from exceeding the current capacitance of the output transistor. An ON/OFF circuit ensures a long battery life. Compared with the voltage regulators using the conventional CMOS process, a larger variety of capacitors are available, including small ceramic capacitors. A super-small WLP-4B package realizes high-density mounting.

■ Features

- Output voltage: 1.5 V to 5.5 V, selectable in 0.1 V steps.
- High-accuracy output voltage: $\pm 1.0\%$
- Low dropout voltage: 190 mV typ. (3.0 V output product, $I_{OUT} = 100$ mA)
- Low current consumption: During operation: 50 μ A typ., 90 μ A max.
During shutdown: 0.1 μ A typ., 1.0 μ A max.
- High peak current capability: 150 mA output is possible (@ $V_{IN} \geq V_{OUT(S)} + 1.0$ V)^{*1}
- Built-in ON/OFF circuit: Ensures long battery life.
- Low ESR capacitor can be used: A ceramic capacitor of 0.47 μ F or more can be used for the output capacitor.
- High ripple rejection: 80 dB typ. (@ 1.0 kHz)
- Built-in overcurrent protector: Overcurrent of output transistor can be restricted.
- Super-small package: WLP-4B
- Lead-free products

*1. Attention should be paid to the power dissipation of the package when the output current is large.

■ Applications

- Power supply for battery-powered devices
- Power supply for personal communication devices
- Power supply for home electric/electronic appliances
- Power supply for cellular phones

■ Package

Package name	Drawing code		
	Package	Tape	Reel
WLP-4B	HB004-A	HB004-A	HB004-A

■ Block Diagram

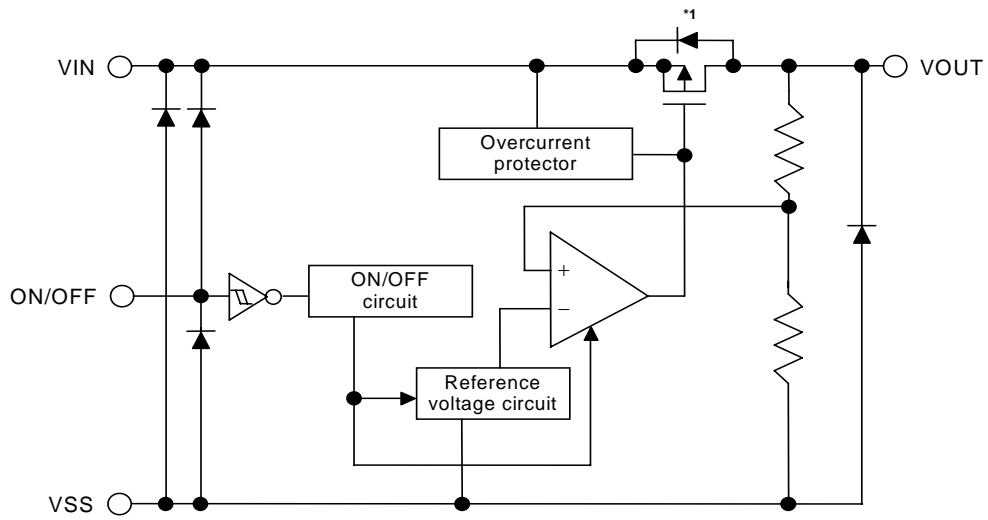

*1. Parasitic diode

Figure 1

■ Product Code Structure

- The product types, output voltage and package name for the S-L2985 Series can be selected at the user's request. Refer to the "Product name" for the meanings of the characters in the product name and "Product name list" for the full product names.

1. Product name

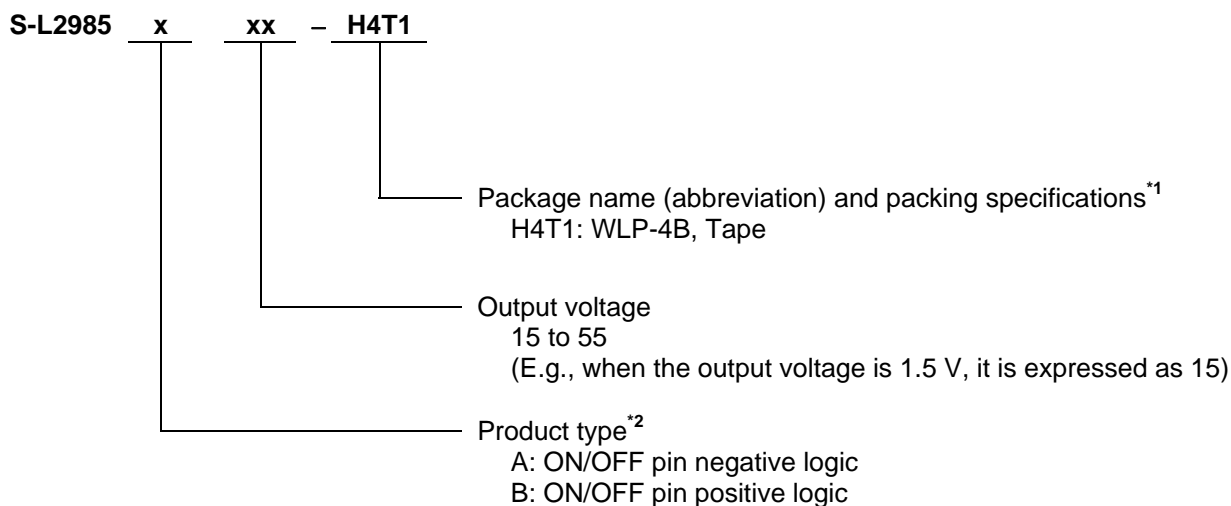

*1. Refer to the taping specifications at the end of this book.

*2. Refer to 3. Shutdown (ON/OFF pin) under the Operation.

2. Product name list

Table 1

Output voltage	WLP-4B
1.5V±1.0%	S-L2985B15-H4T1
1.8V±1.0%	S-L2985B18-H4T1
2.5V±1.0%	S-L2985B25-H4T1
2.6V±1.0%	S-L2985B26-H4T1
2.7V±1.0%	S-L2985B27-H4T1
2.8V±1.0%	S-L2985B28-H4T1
2.9V±1.0%	S-L2985B29-H4T1
3.0V±1.0%	S-L2985B30-H4T1
3.1V±1.0%	S-L2985B31-H4T1
3.2V±1.0%	S-L2985B32-H4T1
3.3V±1.0%	S-L2985B33-H4T1
3.4V±1.0%	S-L2985B34-H4T1
3.5V±1.0%	S-L2985B35-H4T1
5.0V±1.0%	S-L2985B50-H4T1

Remark Please contact the SII marketing department for products with an output voltage other than those specified above or type A products.

■ Pin Configuration

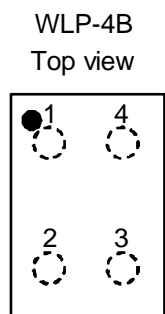

Table 2

Pin No.	Symbol	Description
1	VSS	GND pin
2	VOUT	Output voltage pin
3	VIN	Input voltage pin
4	ON/OFF	Shutdown pin

Figure 2

■ Absolute Maximum Ratings

Table 3

(Ta = 25°C unless otherwise specified)

Item	Symbol	Absolute Maximum Rating	Unit
Input voltage	V_{IN}	$V_{SS} - 0.3$ to $V_{SS} + 7$	V
	$V_{ON/OFF}$	$V_{SS} - 0.3$ to $V_{IN} + 0.3$	
Output voltage	V_{OUT}	$V_{SS} - 0.3$ to $V_{IN} + 0.3$	
Power dissipation	P_D	350 ^{*1}	mW
Operating ambient temperature	T_{opr}	-40 to +85	°C
Storage ambient temperature	T_{stg}	-40 to +125	

*1. When mounted on board

[Mounted board]

(1) Board size : 114.3 mm × 76.2 mm × t1.6 mm

(2) Board name : JEDEC STANDARD51-7

Caution The absolute maximum ratings are rated values exceeding which the product could suffer physical damage. These values must therefore not be exceeded under any conditions.

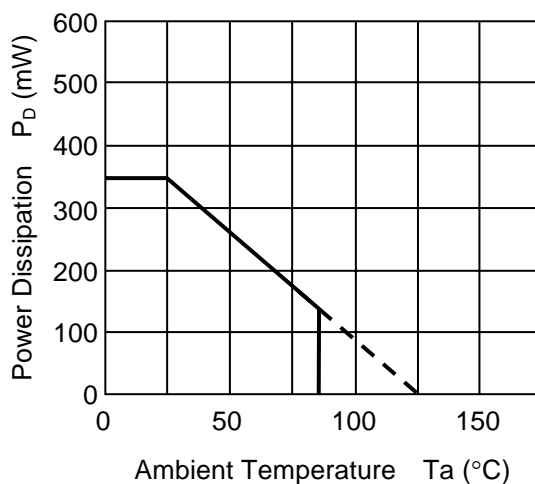

Figure 3 Power Dissipation of Package (When Mounted on Board)

■ **Electrical Characteristics**

Table 4

(Ta = 25°C unless otherwise specified)

Item	Symbol	Conditions	Min.	Typ.	Max.	Unit	Test Circuit	
Output voltage*1	V _{OUT(E)}	V _{IN} = V _{OUT(S)} + 1.0 V, I _{OUT} = 30 mA	V _{OUT(S)} × 0.99	V _{OUT(S)}	V _{OUT(S)} × 1.01	V	1	
Output current*2	I _{OUT}	V _{IN} ≥ V _{OUT(S)} + 1.0 V	150*5	—	—	mA	3	
Dropout voltage*3	V _{drop}	I _{OUT} = 100 mA	1.5 V ≤ V _{OUT(S)} ≤ 1.6 V	—	0.32	0.55	V	1
			1.7 V ≤ V _{OUT(S)} ≤ 1.8 V	—	0.28	0.47		
			1.9 V ≤ V _{OUT(S)} ≤ 2.3 V	—	0.25	0.35		
			2.4 V ≤ V _{OUT(S)} ≤ 2.7 V	—	0.20	0.29		
			2.8 V ≤ V _{OUT(S)} ≤ 5.5 V	—	0.19	0.26		
Line regulation	$\frac{\Delta V_{OUT1}}{\Delta V_{IN} \cdot V_{OUT}}$	V _{OUT(S)} + 0.5 V ≤ V _{IN} ≤ 6.5 V, I _{OUT} = 30 mA	—	0.05	0.2	% / V		
Load regulation	ΔV _{OUT2}	V _{IN} = V _{OUT(S)} + 1.0 V, 1.0 mA ≤ I _{OUT} ≤ 80 mA	—	12	40	mV		
Output voltage temperature coefficient*4	$\frac{\Delta V_{OUT}}{\Delta T_a \cdot V_{OUT}}$	V _{IN} = V _{OUT(S)} + 1.0 V, I _{OUT} = 10 mA, -40°C ≤ Ta ≤ 85°C	—	±100	—	ppm / °C		
Current consumption during operation	I _{SS1}	V _{IN} = V _{OUT(S)} + 1.0 V, ON/OFF pin = ON, no load	—	50	90	μA	2	
Current consumption during shutdown	I _{SS2}	V _{IN} = V _{OUT(S)} + 1.0 V, ON/OFF pin = OFF, no load	—	0.1	1.0			
Input voltage	V _{IN}	—	2.0	—	6.5	V	—	
Shutdown pin input voltage "H"	V _{SH}	V _{IN} = V _{OUT(S)} + 1.0 V, R _L = 1.0 kΩ	1.5	—	—		4	
Shutdown pin input voltage "L"	V _{SL}	V _{IN} = V _{OUT(S)} + 1.0 V, R _L = 1.0 kΩ	—	—	0.3			
Shutdown pin input current "H"	I _{SH}	V _{IN} = 6.5 V, V _{ON/OFF} = 6.5 V	-0.1	—	0.1	μA		
Shutdown pin input current "L"	I _{SL}	V _{IN} = 6.5 V, V _{ON/OFF} = 0 V	-0.1	—	0.1			
Ripple rejection	RR	V _{IN} = V _{OUT(S)} + 1.0 V, f = 1.0 kHz, ΔV _{rip} = 0.5 V _{rms} , I _{OUT} = 30 mA	—	80	—	dB	5	
Short-circuit current	I _{short}	V _{IN} = V _{OUT(S)} + 1.0 V, ON/OFF pin = ON, V _{OUT} = 0 V	—	200	—	mA	3	

*1. V_{OUT(S)}: Specified output voltage

V_{OUT(E)}: Actual output voltage at the fixed load

The output voltage when fixing I_{OUT}(= 30 mA) and inputting V_{OUT(S)} + 1.0 V

*2. The output current at which the output voltage becomes 95% of V_{OUT(E)} after gradually increasing the output current.

*3. V_{drop} = V_{IN1} - (V_{OUT3} × 0.98)

V_{OUT3} is the output voltage when V_{IN} = V_{OUT(S)} + 1.0 V and I_{OUT} = 100 mA.

V_{IN1} is the input voltage at which the output voltage becomes 98% of V_{OUT3} after gradually decreasing the input voltage.

*4. The change in temperature [mV/°C] is calculated using the following equation.

$$\frac{\Delta V_{OUT}}{\Delta T_a} [\text{mV}/^\circ\text{C}]^*1 = V_{OUT(S)} [\text{V}]^*2 \times \frac{\Delta V_{OUT}}{\Delta T_a \cdot V_{OUT}} [\text{ppm}/^\circ\text{C}]^*3 \div 1000$$

*1. The change in temperature of the output voltage

*2. Specified output voltage

*3. Output voltage temperature coefficient

*5. The output current can be at least this value.

Due to restrictions on the package power dissipation, this value may not be satisfied. Attention should be paid to the power dissipation of the package when the output current is large.

■ Test Circuits

1.

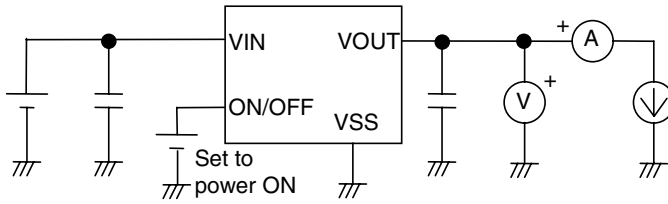

Figure 4

2.

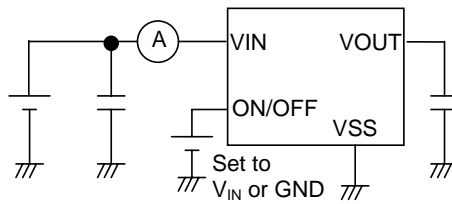

Figure 5

3.

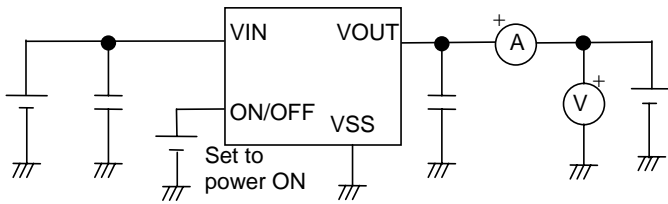

Figure 6

4.

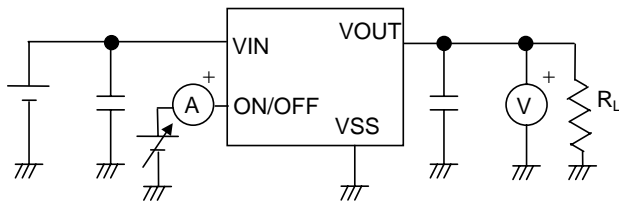

Figure 7

5.

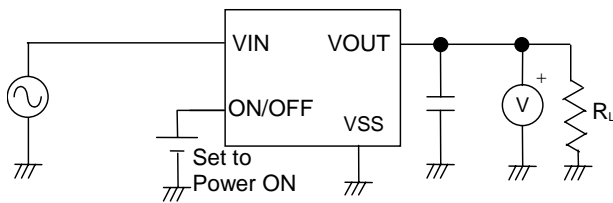
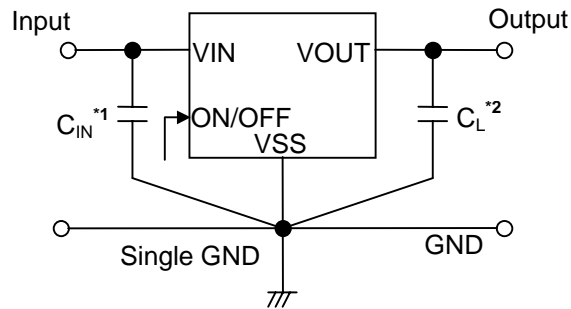

Figure 8

■ Standard Circuit



*1. C_{IN} is a capacitor for stabilizing the input.

*2. A ceramic capacitor of 0.47 μF or more can be used for C_L .

Figure 9

Caution The above connection diagram and constant will not guarantee successful operation. Perform thorough evaluation using the actual application to set the constant.

■ Application Conditions

Input capacitor (C_{IN}): 1.0 μF or more
Output capacitor (C_L): 0.47 μF or more
ESR of output capacitor: 10 Ω or less

Caution A general series regulator may oscillate, depending on the external components selected. Check that no oscillation occurs with the application using the above capacitor.

■ Explanation of Terms

1. Low dropout voltage regulator

The low dropout voltage regulator is a voltage regulator whose dropout voltage is low due to its built-in low on-resistance transistor.

2. Low ESR

A capacitor whose ESR (Equivalent Series Resistance) is low. The S-L2985 Series enables use of a low ESR capacitor, such as a ceramic capacitor, for the output-side capacitor C_L . A capacitor whose ESR is $10\ \Omega$ or less can be used.

3. Output voltage (V_{OUT})

The accuracy of the output voltage is ensured at $\pm 1.0\%$ under the specified conditions of fixed input voltage^{*1}, fixed output current, and fixed temperature.

*1. Differs depending on the product.

Caution If the above conditions change, the output voltage value may vary and exceed the accuracy range of the output voltage. Please see the electrical characteristics and attached characteristics data for details.

4. Line regulation $\left(\frac{\Delta V_{OUT1}}{\Delta V_{IN} \bullet V_{OUT}}\right)$

Indicates the dependency of the output voltage on the input voltage. That is, the values show how much the output voltage changes due to a change in the input voltage with the output current remaining unchanged.

5. Load regulation (ΔV_{OUT2})

Indicates the dependency of the output voltage on the output current. That is, the values show how much the output voltage changes due to a change in the output current with the input voltage remaining unchanged.

6. Dropout voltage (V_{drop})

Indicates the difference between the input voltage V_{IN1} , which is the input voltage (V_{IN}) at the point where the output voltage has fallen to 98% of the output voltage value V_{OUT3} after V_{IN} was gradually decreased from $V_{IN} = V_{OUT(S)} + 1.0\ V$, and the output voltage at that point ($V_{OUT3} \times 0.98$).

$$V_{drop} = V_{IN1} - (V_{OUT3} \times 0.98)$$

7. Temperature coefficient of output voltage $\left(\frac{\Delta V_{OUT}}{\Delta T_a \bullet V_{OUT}}\right)$

The shadowed area in **Figure 10** is the range where V_{OUT} varies in the operating temperature range when the temperature coefficient of the output voltage is ± 100 ppm/ $^{\circ}\text{C}$.

Ex. S-L2985B28 Typ.

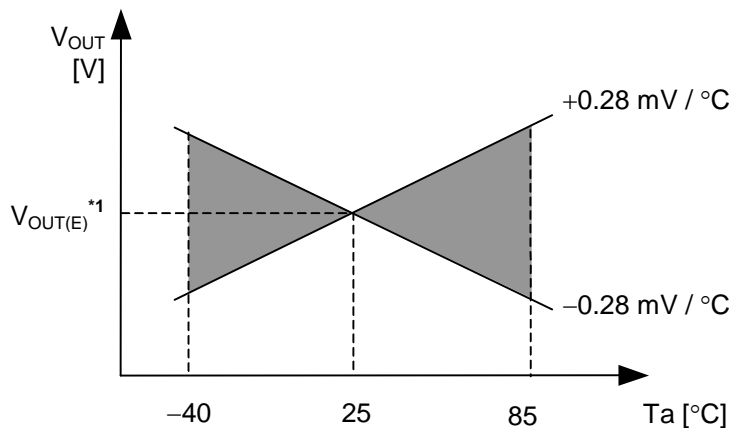

*1. $V_{OUT(E)}$ is the value of the output voltage measured at 25 $^{\circ}\text{C}$.

Figure 10

A change in the temperature of the output voltage [mV/ $^{\circ}\text{C}$] is calculated using the following equation.

$$\frac{\Delta V_{OUT}}{\Delta T_a} [\text{mV}/^{\circ}\text{C}]^{*1} = V_{OUT(S)} [\text{V}]^{*2} \times \frac{\Delta V_{OUT}}{\Delta T_a \bullet V_{OUT}} [\text{ppm}/^{\circ}\text{C}]^{*3} \div 1000$$

- *1. Change in temperature of output voltage
- *2. Specified output voltage
- *3. Output voltage temperature coefficient

■ Operation

1. Basic operation

Figure 11 shows the block diagram of the S-L2985 Series.

The error amplifier compares the reference voltage (V_{ref}) with V_{fb} , which is the output voltage resistance-divided by feedback resistors R_s and R_f . It supplies the output transistor with the gate voltage necessary to ensure a certain output voltage free of any fluctuations of input voltage and temperature.

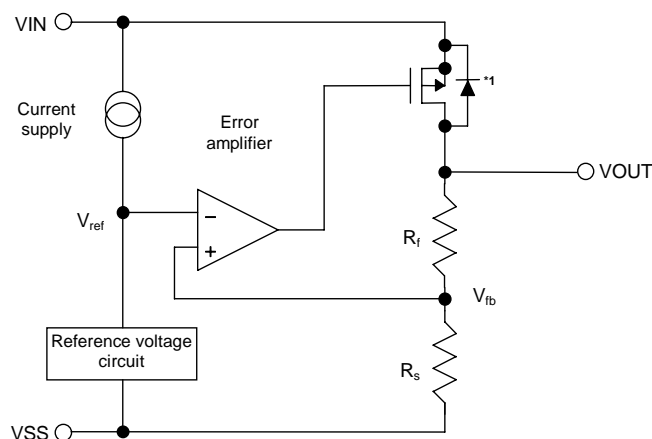

*1. Parasitic diode

Figure 11

2. Output transistor

The S-L2985 Series uses a low on-resistance P-channel MOS FET as the output transistor. Be sure that V_{OUT} does not exceed $V_{IN} + 0.3$ V to prevent the voltage regulator from being damaged due to inverse current flowing from the VOUT pin through a parasitic diode to the VIN pin.

3. Shutdown pin (ON/OFF pin)

This pin starts and stops the regulator.

When the ON/OFF pin is set to the shutdown level, the operation of all internal circuits stops, and the built-in P-channel MOS FET output transistor between the VIN pin and VOUT pin is turned off to substantially reduce the current consumption. The VOUT pin becomes the V_{SS} level due to the internally divided resistance of several MΩ between the VOUT pin and VSS pin.

The structure of the ON/OFF pin is as shown in **Figure 12**. Since the ON/OFF pin is neither pulled down nor pulled up internally, do not use it in the floating state. In addition, note that the current consumption increases if a voltage of 0.3 V to V_{IN} – 0.3 V is applied to the ON/OFF pin. When the ON/OFF pin is not used, connect it to the VSS pin if the logic type is “A” and to the VIN pin if it is “B”.

Table 5

Logic Type	ON/OFF Pin	Internal Circuits	VOUT Pin Voltage	Current Consumption
A	“L”: Power on	Operating	Set value	I _{SS1}
A	“H”: Power off	Stopped	V _{SS} level	I _{SS2}
B	“L”: Power off	Stopped	V _{SS} level	I _{SS2}
B	“H”: Power on	Operating	Set value	I _{SS1}

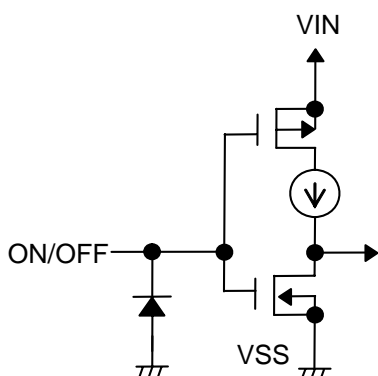

Figure 12

■ Selection of Output Capacitor (C_L)

The S-L2985 Series requires an output capacitor between the VOUT and VSS pins for phase compensation. A ceramic capacitor with a capacitance of 0.47 μF or more can be used. Even if using an OS capacitor, tantalum capacitor, or aluminum electrolytic capacitor, a capacitance of 0.47 μF or more and an ESR of 10 Ω or less are required.

The value of the output overshoot or undershoot transient response varies depending on the value of the output capacitor.

When selecting the output capacitor, perform sufficient evaluation, including evaluation of temperature characteristics, on the actual device.

■ Precautions

- Wiring patterns for the VIN, VOUT and GND pins should be designed so that the impedance is low. When mounting an output capacitor(C_L) or an input capacitor(C_{IN}), the distance from the capacitor to the VOUT pin and to the VSS pin should be as short as possible.
- Note that the output voltage may increase when a series regulator is used at low load current (1.0 mA or less).
- Generally a series regulator may cause oscillation, depending on the selection of external parts. The following conditions are recommended for this IC. However, be sure to perform sufficient evaluation including the temperature characteristic in the actual usage conditions to select the series regulator.

Input capacitor (C_{IN}):	1.0 μ F or more
Output capacitor (C_L):	0.47 μ F or more
Equivalent series resistance (ESR):	10 Ω or less

- The voltage regulator may oscillate when the impedance of the power supply is high and the input capacitor is small or an input capacitor is not connected.
- The application conditions for the input voltage, output voltage, and load current should not exceed the package power dissipation.
- The side of device silicon substrate is exposed to the marking side of device package. Since this portion has lower strength against the mechanical stress than the standard plastic package, be careful of the handling of a package enough against chip, crack etc. Moreover, the exposed side of silicon has electrical potential of device substrate, and needs to be kept out of contact with the external potential.
- In this package, the overcoat of the resin of translucence is carried out on the side of device. Keep it mind that it may affect the characteristic of a device when exposed a device in the bottom of a high light source.
- Do not apply an electrostatic discharge to this IC that exceeds the performance ratings of the built-in electrostatic protection circuit.
- In determining the output current, attention should be paid to the output current value specified in **Table 4** in the electrical characteristics and footnote *5) of the table.
- SII claims no responsibility for any disputes arising out of or in connection with any infringement by products including this IC of patents owned by a third party.

■ Typical Characteristics

(1) Output Voltage vs. Output current (when load current increases)

S-L2985B15 (Ta = 25°C)

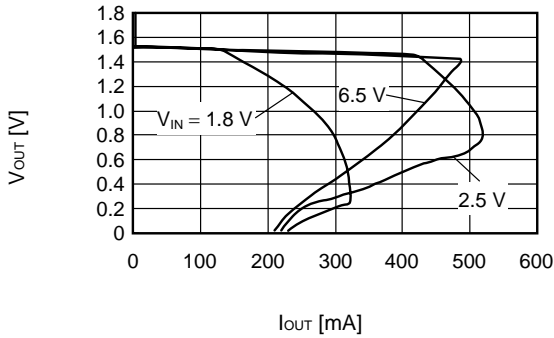

S-L2985B30 (Ta = 25°C)

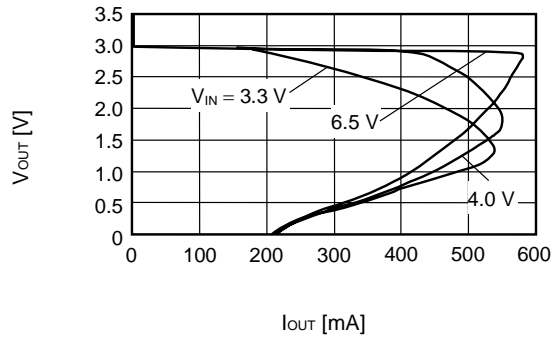

S-L2985B50 (Ta = 25°C)

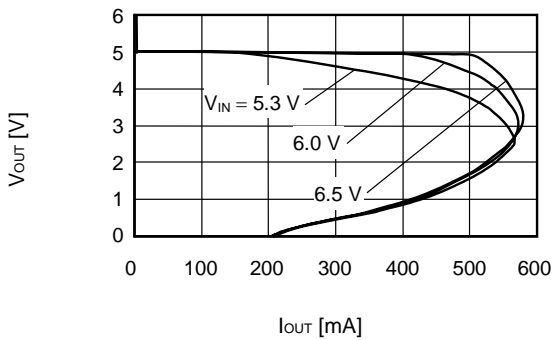

Remark In determining the output current, attention should be paid to the following.

- 1) The minimum output current value and footnote *5 in the electrical characteristics
- 2) The package power dissipation

(2) Output voltage vs. Input voltage

S-L2985B15 (Ta = 25°C)

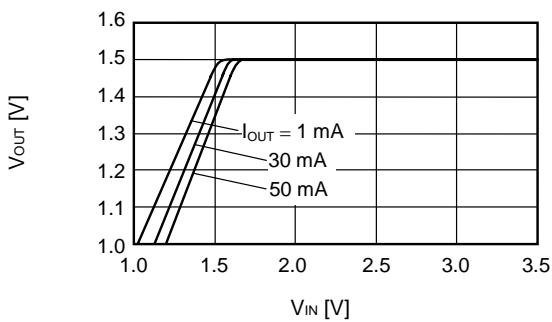

S-L2985B30 (Ta = 25°C)

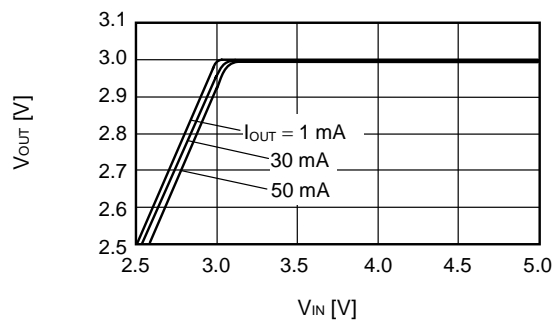

S-L2985B50 (Ta = 25°C)

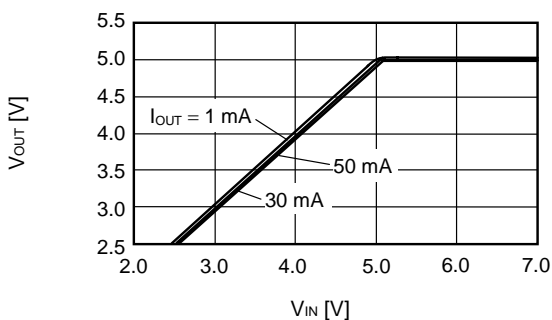

(3) Dropout voltage vs. Output current

S-L2985B15

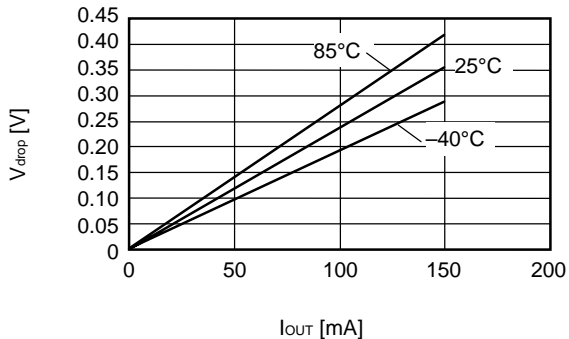

S-L2985B30

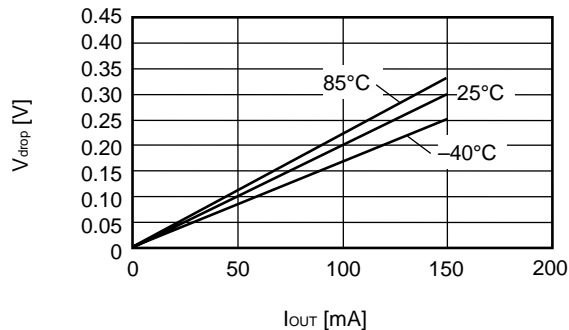

S-L2985B50

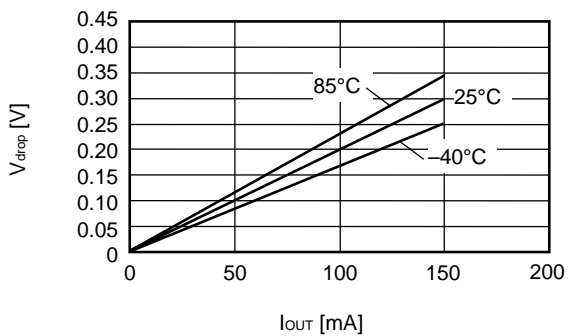

(4) Dropout voltage vs. Set output voltage

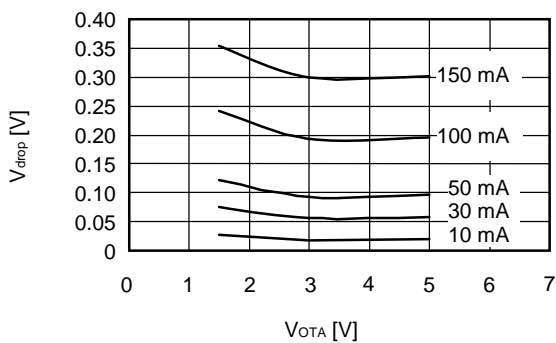

(5) Output voltage vs. Ambient temperature

S-L2985B15

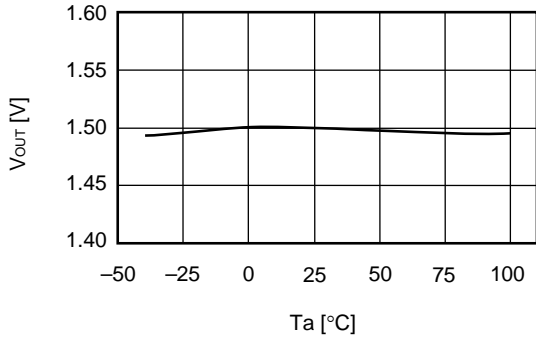

S-L2985B30

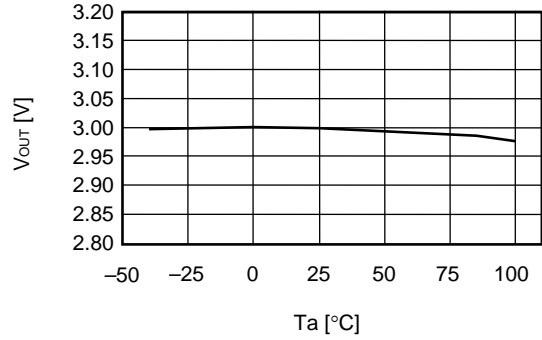

S-L2985B50

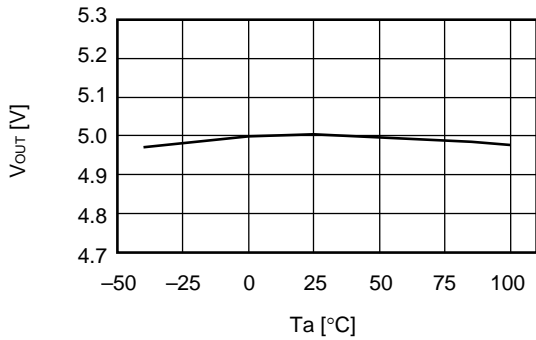

(6) Current consumption vs. Input voltage

S-L2985B15

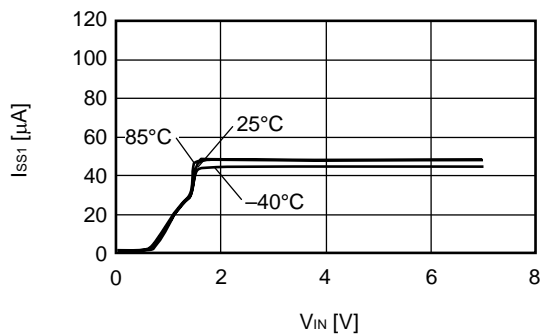

S-L2985B30

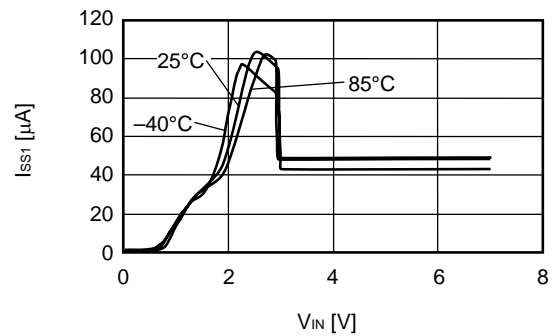

S-L2985B50

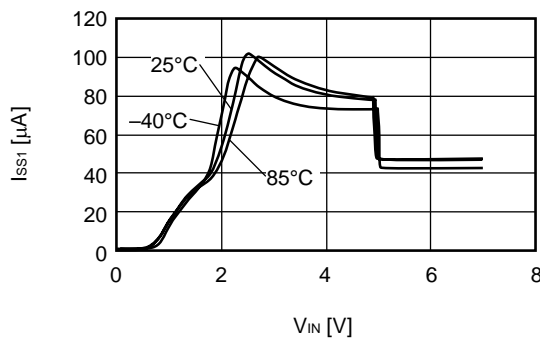

HIGH RIPPLE-REJECTION WLP PACKAGE LOW DROPOUT CMOS VOLTAGE REGULATOR

Rev.2.1_00

S-L2985 Series

(7) Ripple rejection

S-L2985B15 ($T_a = 25^\circ\text{C}$)

$V_{IN} = 2.5\text{ V}$, $C_{OUT} = 0.47\ \mu\text{F}$

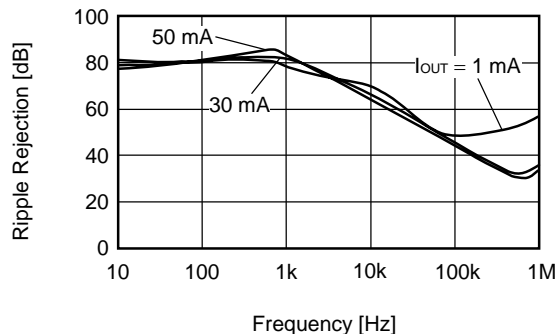

S-L2985B30 ($T_a = 25^\circ\text{C}$)

$V_{IN} = 4.0\text{ V}$, $C_{OUT} = 0.47\ \mu\text{F}$

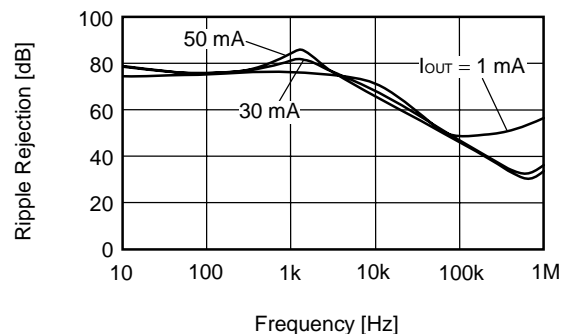

S-L2985B50 ($T_a = 25^\circ\text{C}$)

$V_{IN} = 6.0\text{ V}$, $C_{OUT} = 0.47\ \mu\text{F}$

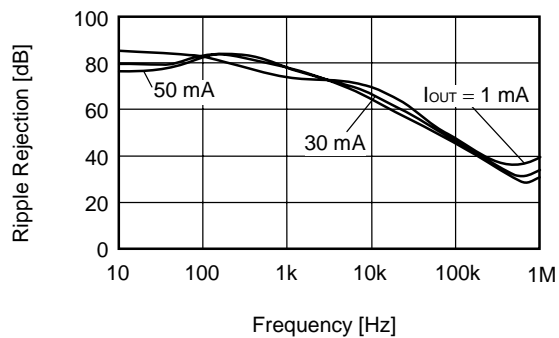

■ **Reference Data**

(1) Input transient response characteristics

S-L2985B15 (Ta = 25°C)

I_{OUT} = 30 mA, tr = tf = 5.0 μs, C_{OUT} = 0.47 μF, C_{IN} = 0 μF

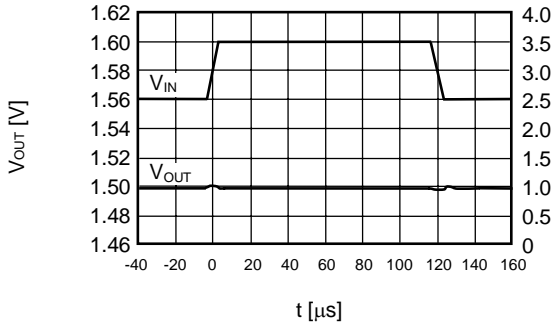

S-L2985B30 (Ta = 25°C)

I_{OUT} = 30 mA, tr = tf = 5.0 μs, C_{OUT} = 0.47 μF, C_{IN} = 0 μF

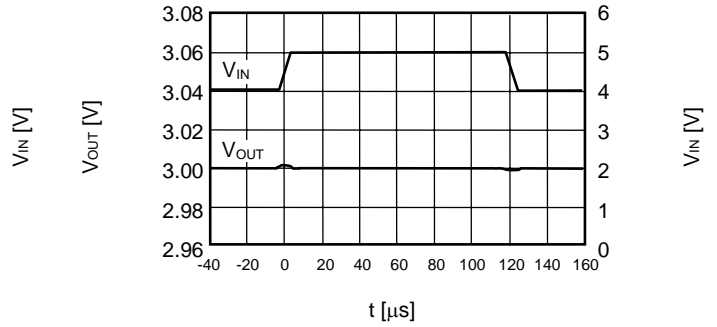

S-L2985B50 (Ta = 25°C)

I_{OUT} = 30 mA, tr = tf = 5.0 μs, C_{OUT} = 0.47 μF, C_{IN} = 0 μF

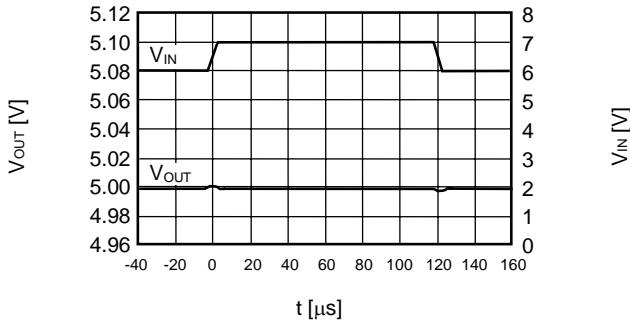

(2) Load transient response characteristics

S-L2985B15 (Ta = 25°C)

V_{IN} = 2.5 V, C_{OUT} = 0.47 μF, C_{IN} = 1.0 μF, I_{OUT} = 50↔100 mA

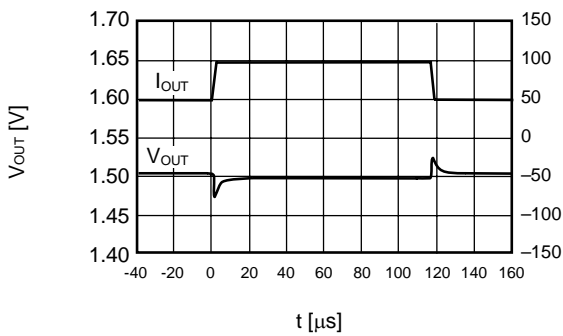

S-L2985B30 (Ta = 25°C)

V_{IN} = 4.0 V, C_{OUT} = 0.47 μF, C_{IN} = 1.0 μF, I_{OUT} = 50↔100 mA

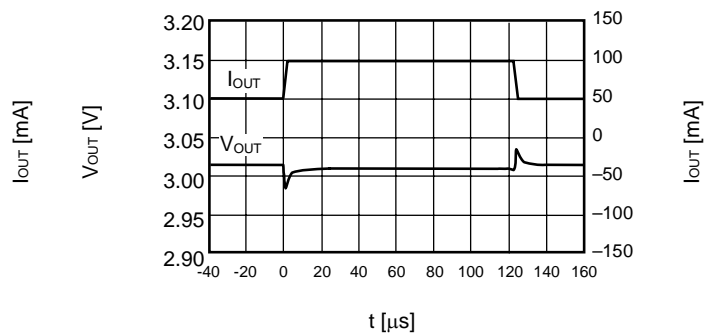

S-L2985B50 (Ta = 25°C)

V_{IN} = 6.0 V, C_{OUT} = 0.47 μF, C_{IN} = 1.0 μF, I_{OUT} = 50↔100 mA

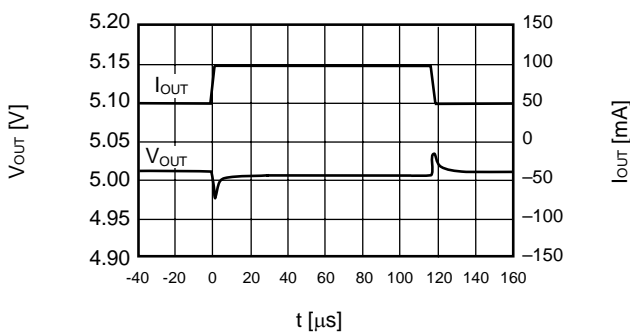

(3) ON/OFF pin transient response characteristics

S-L2985B15 (Ta = 25°C)

V_{IN} = 2.5 V, C_{OUT} = 0.47 μF, C_{IN} = 1.0 μF, I_{OUT} = 100 mA

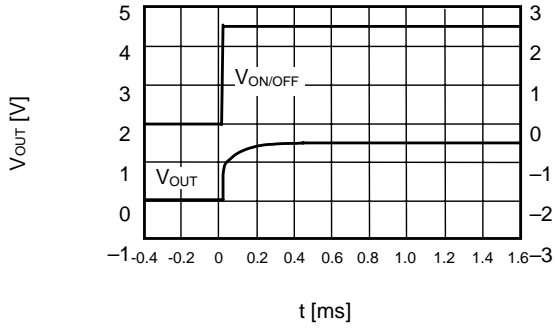

S-L2985B30 (Ta = 25°C)

V_{IN} = 4.0 V, C_{OUT} = 0.47 μF, C_{IN} = 1.0 μF, I_{OUT} = 100 mA

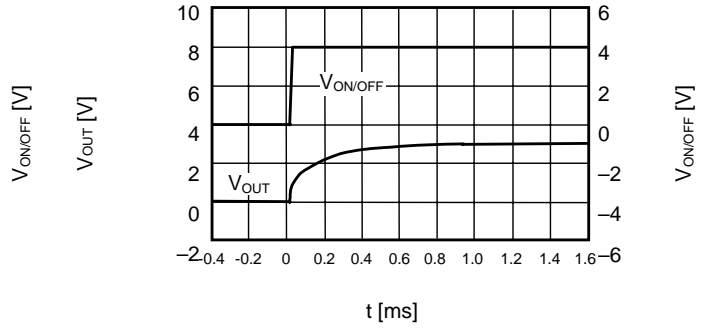

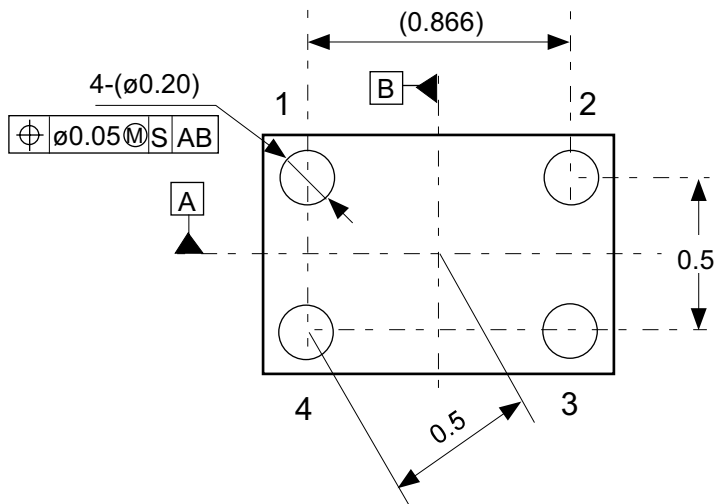
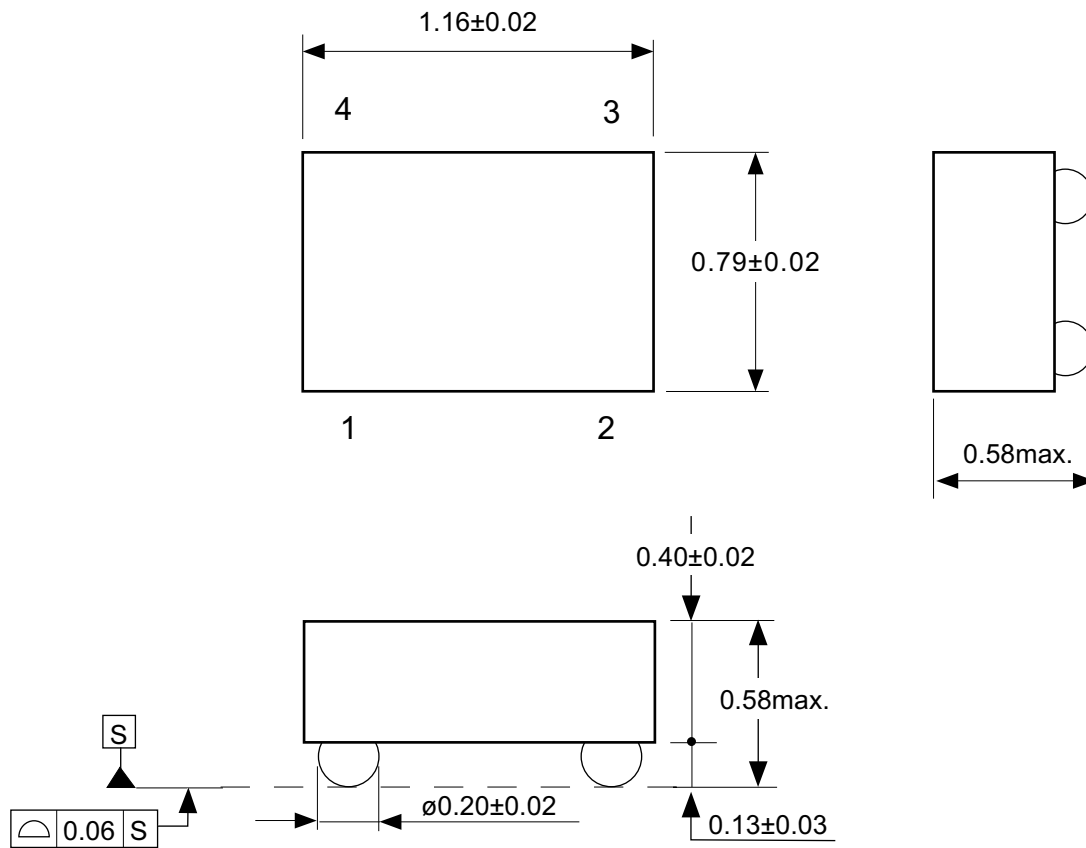

No. HB004-A-P-SD-1.1

TITLE	WLP-4B-A-PKG Dimensions
No.	HB004-A-P-SD-1.1
SCALE	
UNIT	mm
Seiko Instruments Inc.	

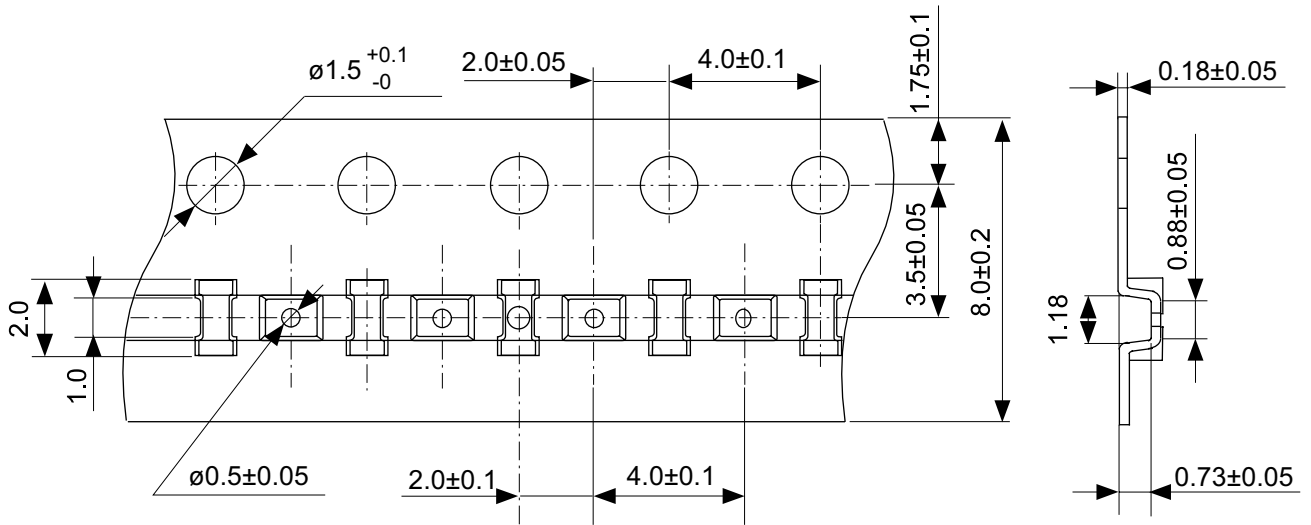

Count mark(R0.3,Depth 0.2)
(Every 10 pockets)

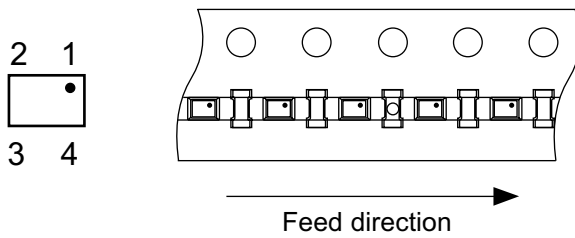
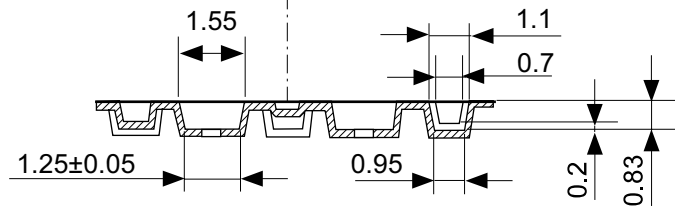

No. HB004-A-C-SD-3.0

TITLE	WLP-4B-A-Carrier Tape
No.	HB004-A-C-SD-3.0
SCALE	
UNIT	mm
Seiko Instruments Inc.	

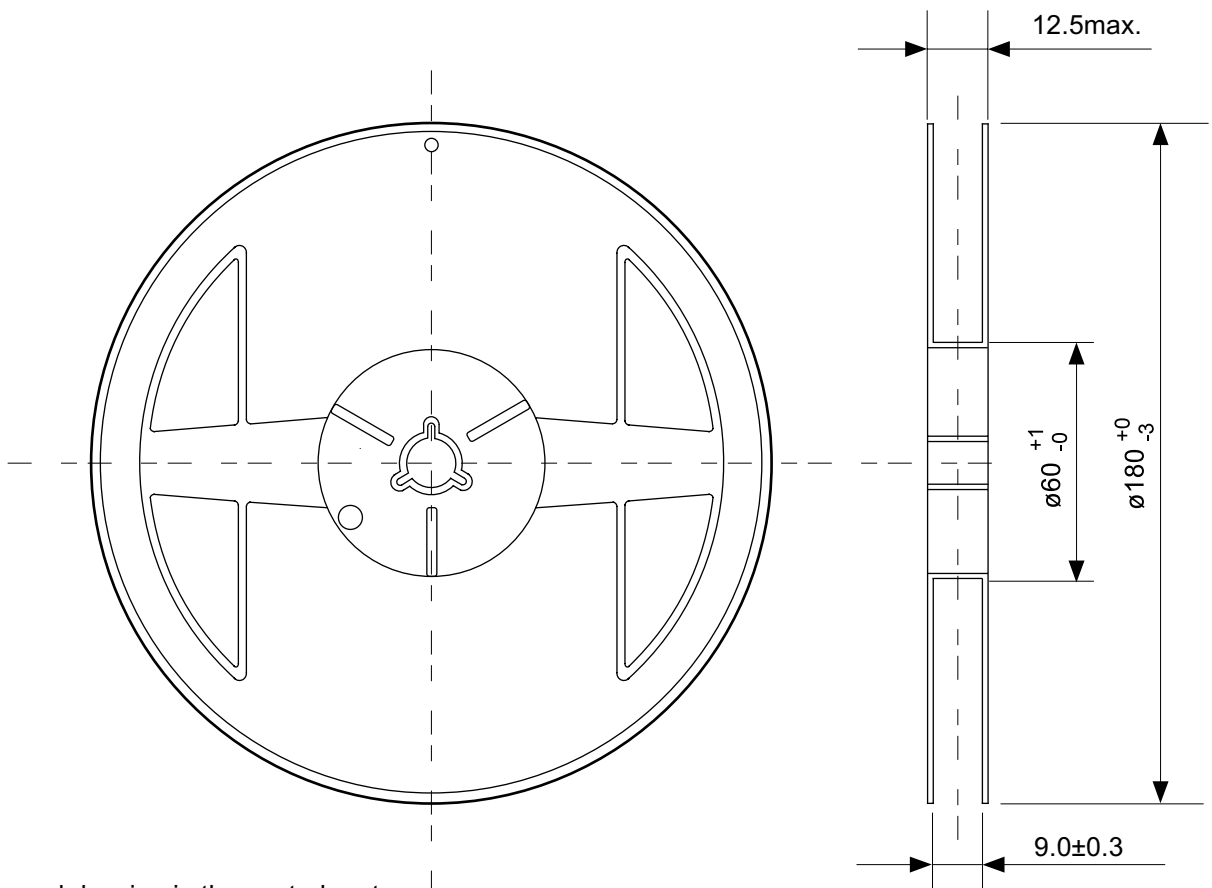

Enlarged drawing in the central part

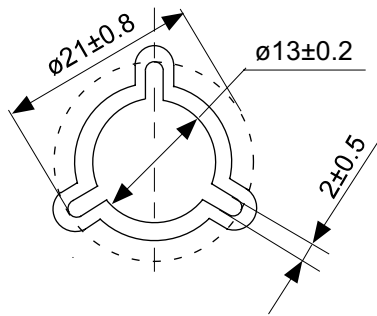

No. HB004-A-R-SD-1.0

TITLE	WLP-4B-A-Reel		
No.	HB004-A-R-SD-1.0		
SCALE		QTY.	3,000
UNIT	mm		
Seiko Instruments Inc.			

- The information described herein is subject to change without notice.
- Seiko Instruments Inc. is not responsible for any problems caused by circuits or diagrams described herein whose related industrial properties, patents, or other rights belong to third parties. The application circuit examples explain typical applications of the products, and do not guarantee the success of any specific mass-production design.
- When the products described herein are regulated products subject to the Wassenaar Arrangement or other agreements, they may not be exported without authorization from the appropriate governmental authority.
- Use of the information described herein for other purposes and/or reproduction or copying without the express permission of Seiko Instruments Inc. is strictly prohibited.
- The products described herein cannot be used as part of any device or equipment affecting the human body, such as exercise equipment, medical equipment, security systems, gas equipment, or any apparatus installed in airplanes and other vehicles, without prior written permission of Seiko Instruments Inc.
- Although Seiko Instruments Inc. exerts the greatest possible effort to ensure high quality and reliability, the failure or malfunction of semiconductor products may occur. The user of these products should therefore give thorough consideration to safety design, including redundancy, fire-prevention measures, and malfunction prevention, to prevent any accidents, fires, or community damage that may ensue.