

### FAST RECOVERY DIODES

### Stud Version

#### Features

- High power FAST recovery diode series
- 1.5 to 2.0  $\mu$ s recovery time
- High voltage ratings up to 1600V
- High current capability
- Optimized turn on and turn off characteristics
- Low forward recovery
- Fast and soft reverse recovery
- Compression bonded encapsulation
- Stud version JEDEC DO-205AB (DO-9)
- Maximum junction temperature 125°C

250A

#### Typical Applications

- Snubber diode for GTO
- High voltage free-wheeling diode
- Fast recovery rectifier applications

#### Major Ratings and Characteristics

Parameters	SD253N/R	Units
$I_{F(AV)}$	250	A
@ $T_C$	85	°C
$I_{F(RMS)}$	392	A
$I_{FSM}$ @ 50Hz	5350	A
@ 60Hz	5600	A
$I^2t$ @ 50Hz	143	KA <sup>2</sup> s
@ 60Hz	130	KA <sup>2</sup> s
$V_{RRM}$ range	400 to 1600	V
$t_{rr}$ range	1.5 to 2.0	$\mu$ s
@ $T_J$	25	°C
$T_J$	- 40 to 125	°C

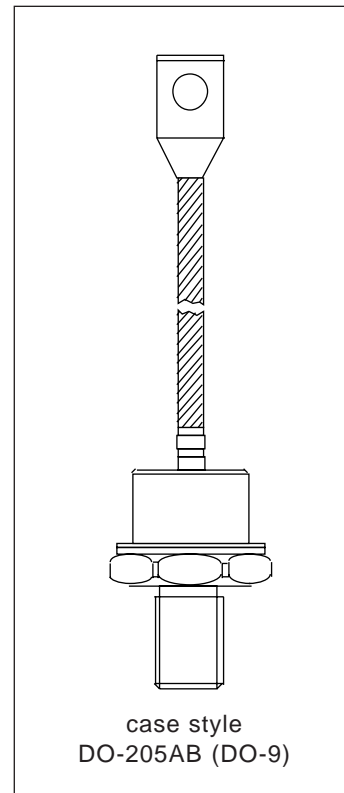

## SD253N/R Series

Bulletin I2065 rev. A 09/94

International  
**IR** Rectifier

### ELECTRICAL SPECIFICATIONS

#### Voltage Ratings

Type number	Voltage Code	$V_{RRM}$ max. repetitive peak and off-state voltage V	$V_{RSM}$ , maximum non-repetitive peak voltage V	$I_{RRM}$ max. $T_J = 125^\circ\text{C}$ mA
SD253N/R..S15	04	400	500	35
	08	800	900	
	10	1000	1100	
SD253N/R..S20	12	1200	1300	
	14	1400	1500	
	16	1600	1700	

#### Forward Conduction

Parameter	SD253N/R	Units	Conditions
$I_{F(AV)}$ Max. average forward current @ Case temperature	250	A	180° conduction, half sine wave.
	85	°C	
$I_{F(RMS)}$ Max. RMS current	392	A	DC @ 74°C case temperature
$I_{FSM}$ Max. peak, one-cycle non-repetitive forward current	5350	A	t = 10ms No voltage
	5600		t = 8.3ms reapplied
	4500		t = 10ms 100% $V_{RRM}$
	4710		t = 8.3ms reapplied
$I^2t$ Maximum $I^2t$ for fusing	143	KA <sup>2</sup> s	t = 10ms No voltage
	130		t = 8.3ms reapplied
	101		t = 10ms 100% $V_{RRM}$
	92		t = 8.3ms reapplied
$I^2\sqrt{t}$ Maximum $I^2\sqrt{t}$ for fusing	1430	KA <sup>2</sup> √s	t = 0.1 to 10ms, no voltage reapplied
$V_{F(TO)1}$ Low level of threshold voltage	0.87	V	(16.7% × π × $I_{F(AV)}$ < I < π × $I_{F(AV)}$ ), $T_J = T_J$ max.
$V_{F(TO)2}$ High level of threshold voltage	1.17		(I > π × $I_{F(AV)}$ ), $T_J = T_J$ max.
$r_{f1}$ Low level of forward slope resistance	0.62	mΩ	(16.7% × π × $I_{F(AV)}$ < I < π × $I_{F(AV)}$ ), $T_J = T_J$ max.
$r_{f2}$ High level of forward slope resistance	0.29		(I > π × $I_{F(AV)}$ ), $T_J = T_J$ max.
$V_{FM}$ Max. forward voltage	1.38	V	$I_{pk} = 785\text{A}$ , $T_J = 25^\circ\text{C}$ , $t_p = 400\ \mu\text{s}$ square pulse

#### Recovery Characteristics

Code	$T_J = 25^\circ\text{C}$ typical $t_{rr}$ @ 25% $I_{RRM}$ (μs)	Test conditions			Max. values @ $T_J = 125^\circ\text{C}$			
		$I_{pk}$ Square Pulse (A)	di/dt (A/μs)	$V_r$ (V)	$t_{rr}$ @ 25% $I_{RRM}$ (μs)	$Q_{rr}$ (μC)	$I_{rr}$ (A)	
S15	1.5	750	25	-30	2.9	90	44	
S20	2.0				3.2	107	46	

**Thermal and Mechanical Specification**

Parameter	SD253N/R	Units	Conditions
T <sub>J</sub> Max. operating temperature range	-40 to 125	°C	
T <sub>stg</sub> Max. storage temperature range	-40 to 150		
R <sub>thJC</sub> Max. thermal resistance, junction to case	0.115	K/W	DC operation
R <sub>thCS</sub> Max. thermal resistance, case to heatsink	0.08		Mounting surface, smooth, flat and greased
T Mounting torque ± 10%	31	Nm	Not lubricated threads
	24.5		Lubricated threads
wt Approximate weight	250	g	
Case style	DO-205AB (DO-9)		See Outline Table

**ΔR<sub>thJC</sub> Conduction**

(The following table shows the increment of thermal resistance R<sub>thJC</sub> when devices operate at different conduction angles than DC)

Conduction angle	Sinusoidal conduction	Rectangular conduction	Units	Conditions
180°	0.010	0.008	K/W	T <sub>J</sub> = T <sub>J</sub> max.
120°	0.013	0.014		
90°	0.017	0.019		
60°	0.025	0.027		
30°	0.044	0.044		

**Ordering Information Table**

**Device Code**

SD	25	3	R	16	S20	P	B	V
①	②	③	④	⑤	⑥	⑦	⑧	⑨

- 1** - Diode
- 2** - Essential part number
- 3** - 3 = Fast recovery
- 4** - N = Stud Normal Polarity (Cathode to Stud)  
R = Stud Reverse Polarity (Anode to Stud)
- 5** - Voltage code: Code x 100 = V<sub>RRM</sub> (see Voltage Ratings table)
- 6** - t<sub>rr</sub> code (see Recovery Characteristics table)
- 7** - P = Stud base DO-205AB (DO-9) 3/4" 16UNF-2A  
M = Stud base DO-205AB (DO-9) M16 X 1.5
- 8** - B = Flag top terminals (for Cathode/ Anode Leads)  
S = Isolated lead with silicone sleeve  
(Red = Reverse Polarity; Blue = Normal Polarity)  
None = Not isolated lead
- 9** - V = Glass-metal seal

**SD253N/R Series**

Bulletin I2065 rev. A 09/94

Outline Table

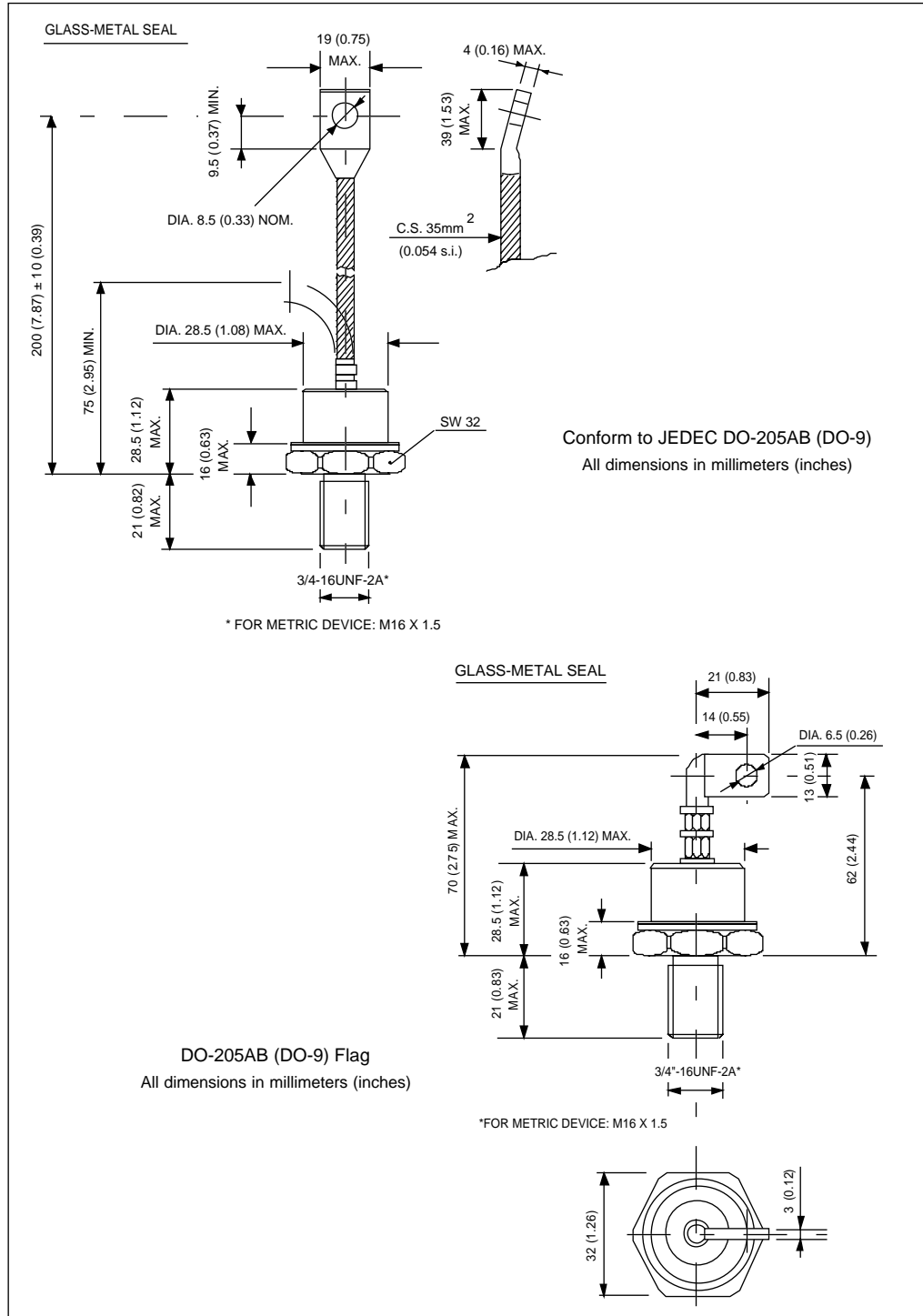

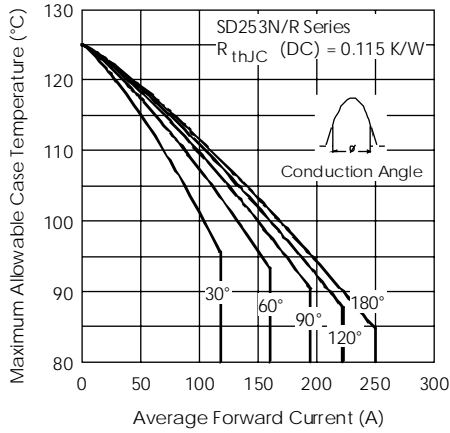

Fig. 1 - Current Ratings Characteristics

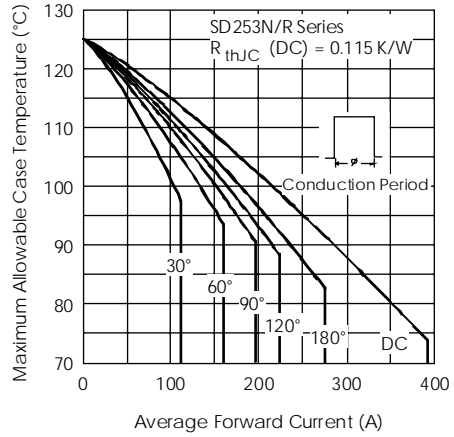

Fig. 2 - Current Ratings Characteristics

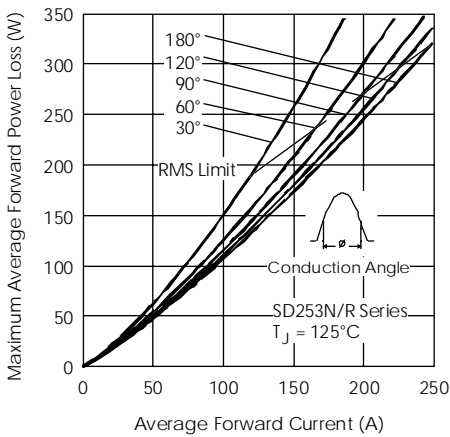

Fig. 3 - Forward Power Loss Characteristics

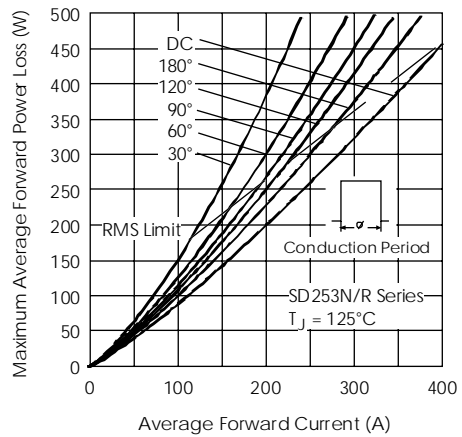

Fig. 4 - Forward Power Loss Characteristics

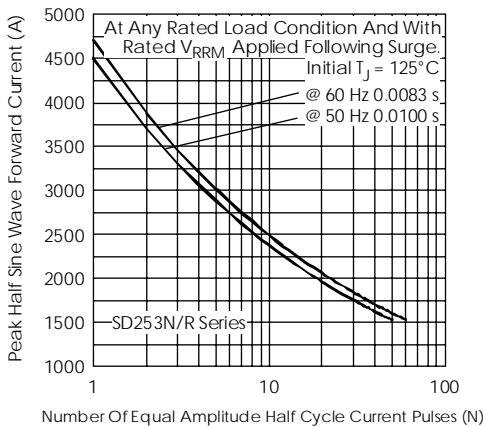

Fig. 5 - Maximum Non-repetitive Surge Current

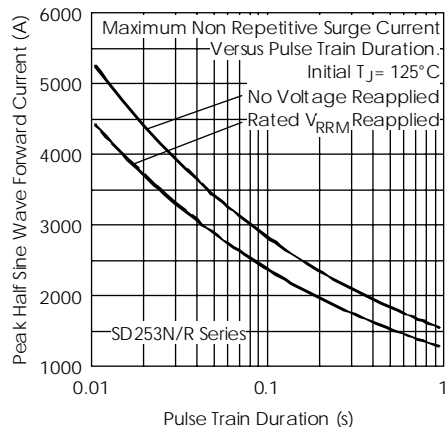

Fig. 6 - Maximum Non-repetitive Surge Current

# SD253N/R Series

Bulletin I2065 rev. A 09/94

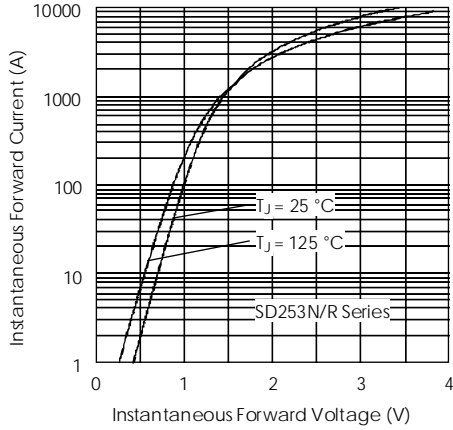

Fig. 7 - Forward Voltage Drop Characteristics

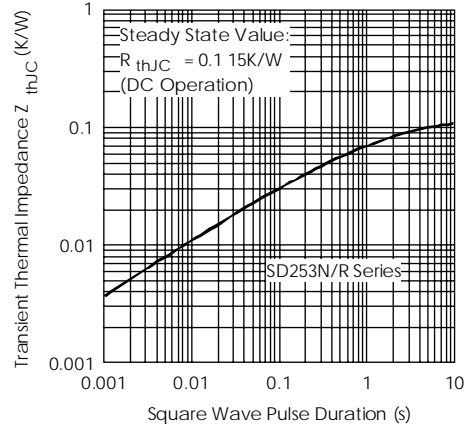

Fig. 8 - Thermal Impedance  $Z_{thJC}$  Characteristic

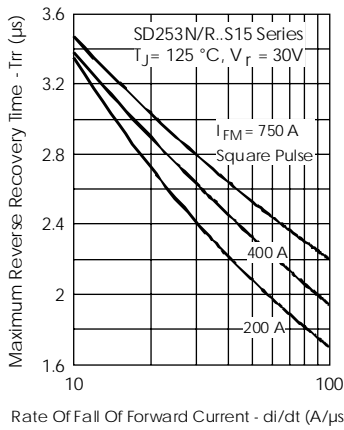

Fig. 9 - Recovery Time Characteristics

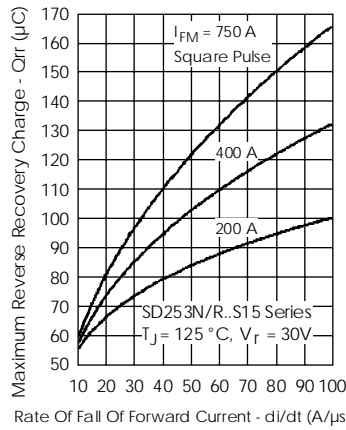

Fig. 10 - Recovery Charge Characteristics

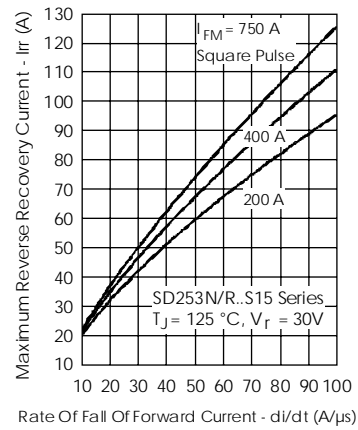

Fig. 11 - Recovery Current Characteristics

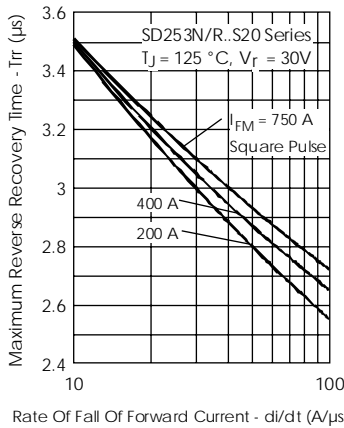

Fig. 12 - Recovery Time Characteristics

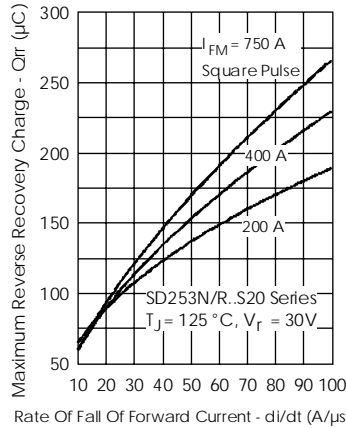

Fig. 13 - Recovery Charge Characteristics

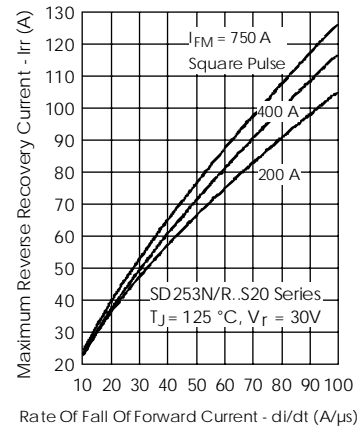

Fig. 14 - Recovery Current Characteristics

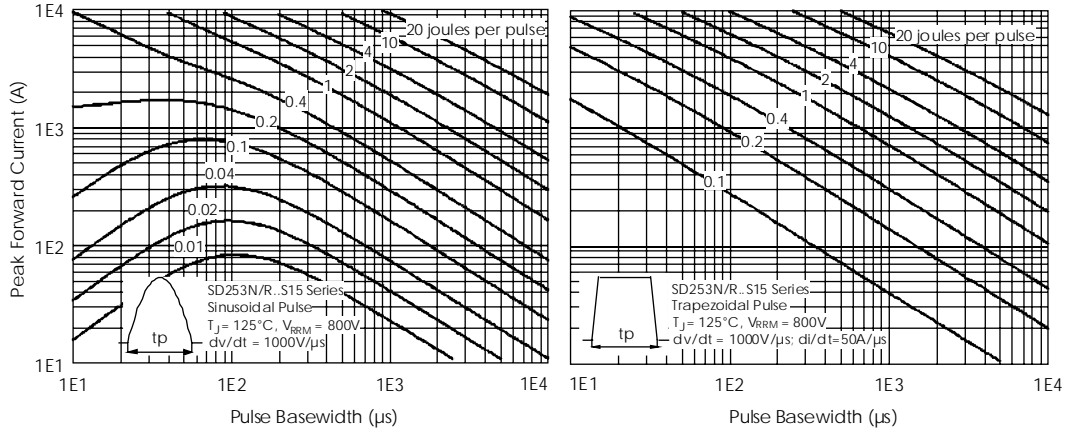

Fig. 15 - Maximum Total Energy Loss Per Pulse Characteristics

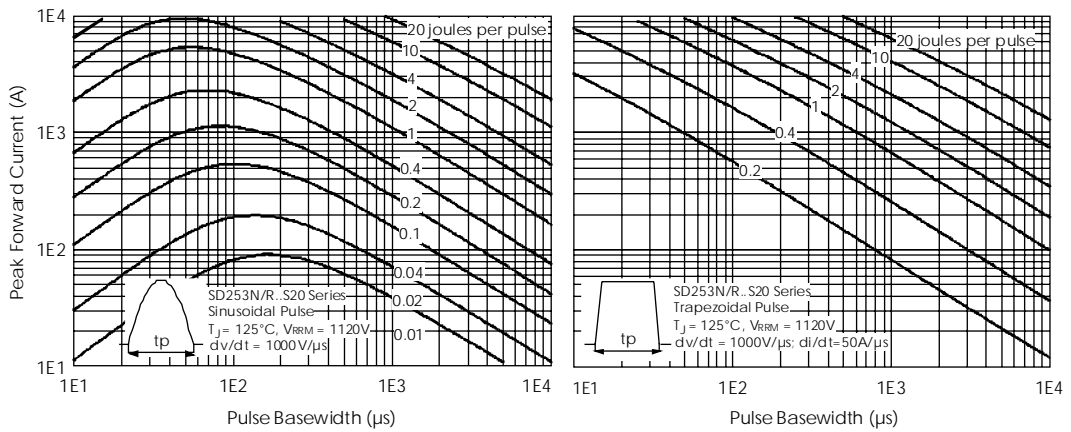

Fig. 16 - Maximum Total Energy Loss Per Pulse Characteristics