

Leaded Varistors

Taping

Taping (leaded varistors)

All leaded varistors are available on tape.

Exception: S10K510 ... K680, S14K510 ... K1000, S20K385 ... K1000.

Tape packaging for lead spacing \boxed{e} = 5 fully conforms to IEC 60286-2, while for lead spacings \boxed{e} = 7,5 and 10 the taping mode is based on this standard.

The ordering tables on page 213 ff list disk types available on tape in detail, i. e. with complete type designation and ordering code. Taping mode and, if relevant, crimp style and lead spacing are coded in the type designation. For types not listed please contact EPCOS. Upon request parts with lead spacing \boxed{e} = 5 mm are available in Ammopack too.

Designation system for taping mode

Type designation bulk	Taped, reel type	Crimp style (if relevant)	Lead spacing (if relevant)
default = no extra designation	G } G2 } G3 } see page 208 G4 } G5 }	S } S2 } S3 } see page 212 S4 } S5 }	R5 Lead spacing differs from standard version R7
	Taped, Ammopack		
	GA } G2A } see page 209		

Example SIOV-S10K250GS3R5

SIOV-S10K250	G	S3	R5
	Taped Reel type I Seating plane height $H_0 = 16$	Crimp style 3	Lead spacing 5,0 (differs from LS 7,5 of standard version S10K250)

Example SIOV-S07K60G2AS2

SIOV-S07K60	G2A	S2	—
	Taped Seating plane height $H_0 = 18$ Ammopack	Crimp style 2	—

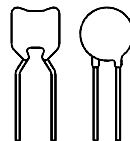

Taping modes/reel types

Taped varistors have the letter “G” appended to the type designation.

The different tapes and matching reel types are identified by numbers as shown in the table on page 208.

Types with lead spacing \boxed{e} = 5, reel diameter 360 mm, have the code letter “G” while types with lead spacing \boxed{e} = 7,5 and 10 on 500-mm reels are identified by “G5”.

Furthermore types with lead spacing \boxed{e} = 5 are available in Ammopack, code letters “GA”.

Versions G2, G3 and G4 are special tapes on 360-mm reels resp. Ammopack: G2 denotes the seating plane height $H_0 = 18$ for crimped versions. Tapes G3 and G4 are available on 360-mm reels in case the 500-mm reels are too big for your insertion machine.

Crimp styles

Both crimped and straight leads are standard for taped disk varistors. The leads are differently crimped for technical reasons; the individual crimp styles are denoted by consecutive numbers (S, S2 ... S5) as shown in the dimensional drawings on page 212.

The crimp styles of the individual types can be seen from the type designation in the ordering tables.

Example straight leads: S10K250G5

Example crimped leads: S10K250G5S5

Lead spacing

Type series SIOV-S10 is available with two different lead spacings:

\boxed{e} = 5,0 (wire \varnothing 0,6 mm)

\boxed{e} = 7,5 (wire \varnothing 0,8 mm)

For taped varistors having a different lead spacing from their untaped equivalents, the actual \boxed{e} is appended to type designation.

Example: S10K250GS3R5

The standard lead spacing of series SIOV-S10 is \boxed{e} = 7,5. The version with \boxed{e} = 5,0 has the appendix “R5”.

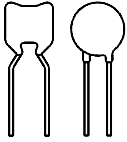

Leaded Varistors

Taping

Assignment of taping mode to reel type

Taping mode	Reel type	Seating plane height H_0 for crimped types mm	Seating plane height H for uncrimped types mm
G ¹⁾	I	16	18
G2	I	18	—
G3	II	16	18
G4	II	18	—
G5	III	16	18
GA	Ammopack	16	18
G2A	Ammopack	18	—

Taping modes G2, G3, G4, GA and G2A: delivery upon request.

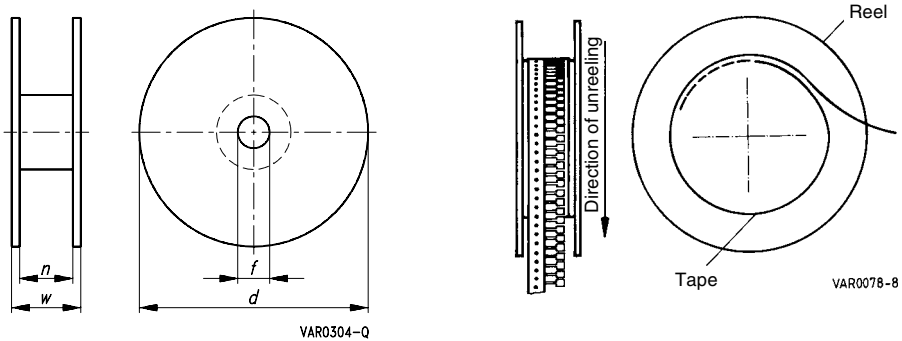

Reel dimensions (in mm)

Reel type	d	f	n	w
I	360 max.	31 ± 1	approx. 45	54 max.
II	360 max.	31 ± 1	approx. 55	64 max.
III	500 max.	23 ± 1	approx. 59	72 max.

If reel type III is not compatible with insertion equipment because of its large diameter, type series S10 and S14 can be supplied on reel II upon request (taping mode G3).

1) "1" is omitted.

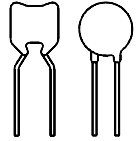

Ammopack dimensions

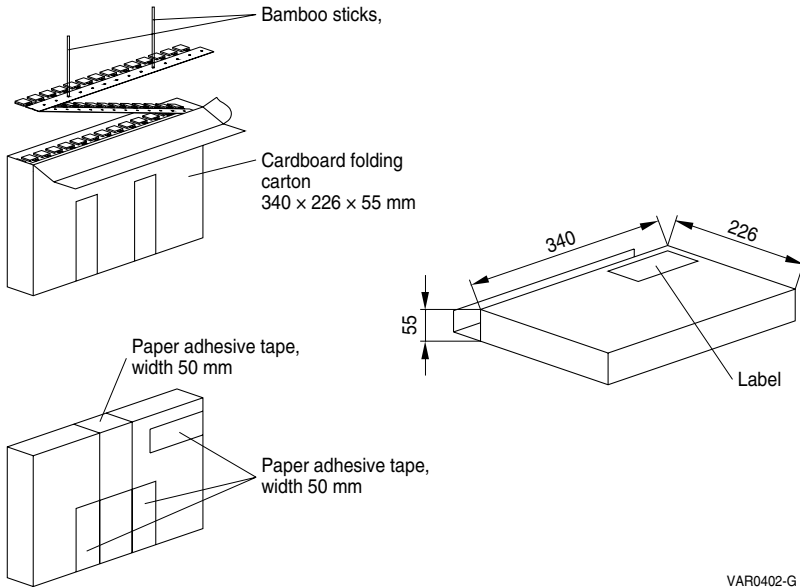

VAR0402-G

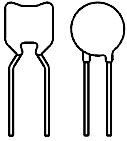

Leaded Varistors

Taping

Taping in accordance with IEC 60286-2

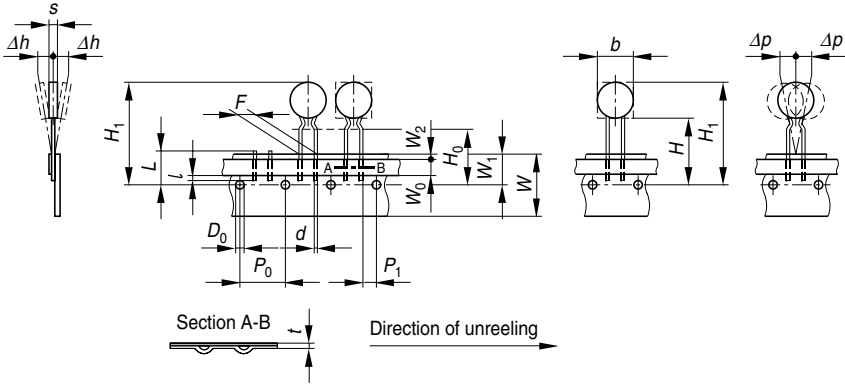

$$F \triangleq \boxed{e} = 5,0 \text{ mm (except S ... R5)}$$

VAR0410-X

Taping based on IEC 60286-2

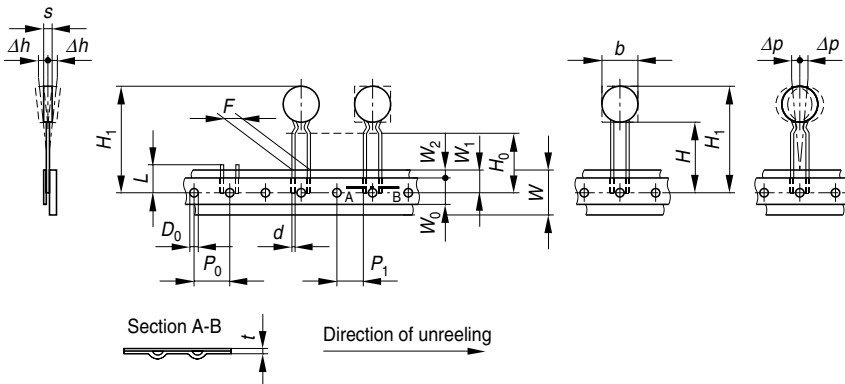

$$F \triangleq \boxed{e} = 7,5 \text{ mm (including S ... R5)}$$

$$F \triangleq \boxed{e} = 10 \text{ mm (including S ... R5)}$$

VAR0395-J

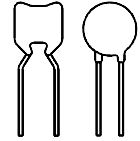
Leaded Varistors
Taping
Tape dimensions (in mm)

Symbol	$\overline{e} = 5,0$	Tolerance	$\overline{e} = 7,5$	Tolerance	$\overline{e} = 10,0$	Tolerance	Remarks
<i>b</i>		max.		max.		max.	see tables on page 169 ff
<i>s</i>		max.		max.		max.	
<i>d</i>	0,6 ¹⁾	± 0,05	0,8	± 0,05	1,0	± 0,05	
<i>P</i> ₀	12,7	± 0,3	12,7 ²⁾	± 0,3	12,7	± 0,3	± 1 mm/20 sprocket holes
<i>P</i> ₁	3,85	± 0,7	8,95	± 0,8	7,7	± 0,8	
<i>F</i>	5,0	+ 0,6/− 0,1	7,5	± 0,8	10,0	± 0,8	measured at top of compo- nent body
Δh	0	± 2,0	depends on <i>s</i>		depends on <i>s</i>		
Δp	0	± 1,3	0	± 2,0	0	± 2,0	
<i>W</i>	18,0	± 0,5	18,0	± 0,5	18,0	± 0,5	Peel-off force ≥ 5 N
<i>W</i> ₀	5,5	min.	11,0	min.	11,0	min.	
<i>W</i> ₁	9,0	± 0,5	9,0	+ 0,75/− 0,5	9,0	+ 0,75/− 0,5	
<i>W</i> ₂	3,0	max.	3,0	max.	3,0	max.	
<i>H</i>	18,0	+ 2,0/− 0	18,0	+ 2,0/− 0	18,0	+ 2,0/− 0	³⁾ ⁴⁾
<i>H</i> ₀	16,0 (18,0)	± 0,5	16,0 (18,0)	± 0,5	16,0	± 0,5	
<i>H</i> ₁	32,2	max.	45,0	max.	45,0	max.	
<i>D</i> ₀	4,0	± 0,2	4,0	± 0,2	4,0	± 0,2	without lead
<i>t</i>	0,9	max.	0,9	max.	0,9	max.	
<i>L</i>	11,0	max.	11,0	max.	11,0	max.	
<i>l</i>	4,0	max.					

1) SHCV 0,5

2) Taping with *P*₀ = 15,0 mm upon request

3) Applies only to uncrimped types

4) Applies only to crimped types (*H*₀ = 18 upon request)

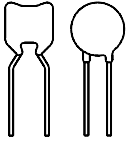

Leaded Varistors

Taping

Standard crimp styles

Crimp style S²)

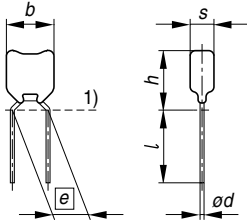

VAR0403-O

Crimp style S2

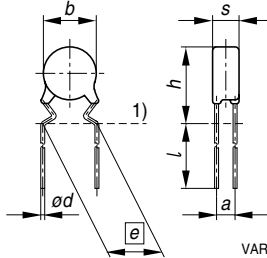

VAR0411-F

Crimp style S3

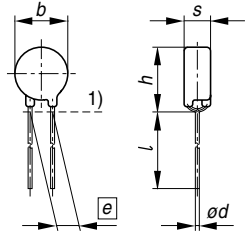

VAR0396-R

1) Seating plane according to IEC 60717

Crimp style S4

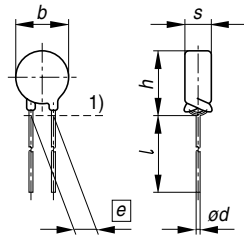

1) Seating plane according to IEC 60717

VAR0404-W

Crimp style S5

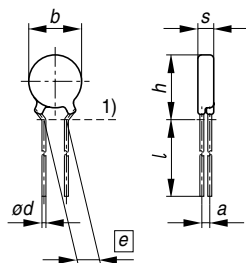

1) Seating plane according to IEC 60717

VAR0412-N

Type	e mm	h_{max} mm
SIOV-		
S05K11 ... 175(E2)S2	5,0	10,0
S05K210 ... 460(E2)S3	5,0	10,0
S07K11 ... 175(E2)S2	5,0	12,0
S07K210 ... 460(E2)S3	5,0	12,0
S10K11 ... 300(E2)S5	7,5	15,5
S10K320 ... 460(E2)(S3)(S5)	7,5	16,5
S10K510(E2)(S3)(S5)	7,5	17,5
S10 ... AUTOS5	7,5	17,0
S10 ... AUTOD1S5	7,5	16,0
S10K11 ... 175(E2)S4R5	5,0	16,5
S10K210 ... 460(E2)S3R5	5,0	16,5
S14K11 ... 300(E2)S5	7,5	20,0
S14K320 ... 460(E2)(S3)(S5)	7,5	20,0
S14K510(E2)(S3)(S5)	7,5	21,5
S14 ... AUTOS5	7,5	21,0
S14 ... AUTOD1S5	7,5	20,0
S20K11 ... 320(E2)(E3)S5	10,0	27,0
S20K385 ... 510(E2)S5	10,0	27,5

Missing dimensions are shown on page 169 ff.

2) "1" is omitted.

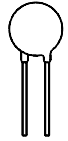
Leaded Varistors
Taping

Type	Ordering code	Crimp style	Pieces/reel I
Type series SIOV-S05, straight leads $e = 5,0$			
SIOV-S05K11G	B72205S0110K111	—	1500
SIOV-S05K14G	B72205S0140K111	—	1500
SIOV-S05K17G	B72205S0170K111	—	1500
SIOV-S05K20G	B72205S0200K111	—	1500
SIOV-S05K25G	B72205S0250K111	—	1500
SIOV-S05K30G	B72205S0300K111	—	1500
SIOV-S05K35G	B72205S0350K111	—	1500
SIOV-S05K40G	B72205S0400K111	—	1500
SIOV-S05K50G	B72205S0500K111	—	1500
SIOV-S05K60G	B72205S0600K111	—	1500
SIOV-S05K75G	B72205S0750K111	—	1500
SIOV-S05K95G	B72205S0950K111	—	1500
SIOV-S05K115G	B72205S0111K111	—	1500
SIOV-S05K130G	B72205S0131K111	—	1500
SIOV-S05K140G	B72205S0141K111	—	1500
SIOV-S05K150G	B72205S0151K111	—	1500
SIOV-S05K175G	B72205S0171K111	—	1500
SIOV-S05K230G	B72205S0231K111	—	1500
SIOV-S05K250G	B72205S0251K111	—	1500
SIOV-S05K275G	B72205S0271K111	—	1500
SIOV-S05K300G	B72205S0301K111	—	1000
Type series SIOV-S05, crimped leads $e = 5,0$			
SIOV-S05K11GS2	B72205S0110K211	S2	1500
SIOV-S05K14GS2	B72205S0140K211	S2	1500
SIOV-S05K17GS2	B72205S0170K211	S2	1500
SIOV-S05K20GS2	B72205S0200K211	S2	1500
SIOV-S05K25GS2	B72205S0250K211	S2	1500
SIOV-S05K30GS2	B72205S0300K211	S2	1500
SIOV-S05K35GS2	B72205S0350K211	S2	1500
SIOV-S05K40GS2	B72205S0400K211	S2	1500
SIOV-S05K50GS2	B72205S0500K211	S2	1500
SIOV-S05K60GS2	B72205S0600K211	S2	1500
SIOV-S05K75GS2	B72205S0750K211	S2	1500
SIOV-S05K95GS2	B72205S0950K211	S2	1500

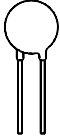

Leaded Varistors

Taping

Type	Ordering code	Crimp style	Pieces/reel I
Type series SIOV-S05, crimped leads [e] = 5,0 (continued)			
SIOV-S05K115GS2	B72205S0111K211	S2	1500
SIOV-S05K130GS2	B72205S0131K211	S2	1500
SIOV-S05K140GS2	B72205S0141K211	S2	1500
SIOV-S05K150GS2	B72205S0151K211	S2	1500
SIOV-S05K175GS2	B72205S0171K211	S2	1500
SIOV-S05K230GS3	B72205S0231K311	S3	1500
SIOV-S05K250GS3	B72205S0251K311	S3	1500
SIOV-S05K275GS3	B72205S0271K311	S3	1500
SIOV-S05K300GS3	B72205S0301K311	S3	1000
SIOV-S05K385GS3	B72205S0381K311	S3	1000
SIOV-S05K420GS3	B72205S0421K311	S3	1000
SIOV-S05K440GS3	B72205S0441K311	S3	1000
SIOV-S05K460GS3	B72205S0461K311	S3	1000
Type series SIOV-S07, straight leads [e] = 5,0			
SIOV-S07K11G	B72207S0110K111	—	1500
SIOV-S07K14G	B72207S0140K111	—	1500
SIOV-S07K17G	B72207S0170K111	—	1500
SIOV-S07K20G	B72207S0200K111	—	1500
SIOV-S07K25G	B72207S0250K111	—	1500
SIOV-S07K30G	B72207S0300K111	—	1500
SIOV-S07K35G	B72207S0350K111	—	1500
SIOV-S07K40G	B72207S0400K111	—	1500
SIOV-S07K50G	B72207S0500K111	—	1500
SIOV-S07K60G	B72207S0600K111	—	1500
SIOV-S07K75G	B72207S0750K111	—	1500
SIOV-S07K95G	B72207S0950K111	—	1500
SIOV-S07K115G	B72207S0111K111	—	1500
SIOV-S07K130G	B72207S0131K111	—	1500
SIOV-S07K140G	B72207S0141K111	—	1500
SIOV-S07K150G	B72207S0151K111	—	1500
SIOV-S07K175G	B72207S0171K111	—	1500
SIOV-S07K230G	B72207S0231K111	—	1500
SIOV-S07K250G	B72207S0251K111	—	1500
SIOV-S07K275G	B72207S0271K111	—	1000
SIOV-S07K300G	B72207S0301K111	—	1000

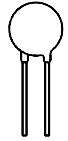

Leaded Varistors
Taping

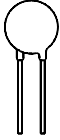
Type	Ordering code	Crimp style	Pieces/reel I
Type series SIOV-S07, crimped leads $e = 5,0$			
SIOV-S07K11GS2	B72207S0110K211	S2	1500
SIOV-S07K14GS2	B72207S0140K211	S2	1500
SIOV-S07K17GS2	B72207S0170K211	S2	1500
SIOV-S07K20GS2	B72207S0200K211	S2	1500
SIOV-S07K25GS2	B72207S0250K211	S2	1500
SIOV-S07K30GS2	B72207S0300K211	S2	1500
SIOV-S07K35GS2	B72207S0350K211	S2	1500
SIOV-S07K40GS2	B72207S0400K211	S2	1500
SIOV-S07K50GS2	B72207S0500K211	S2	1500
SIOV-S07K60GS2	B72207S0600K211	S2	1500
SIOV-S07S60AGS2	B72207S0600S212	S2	1500
SIOVS007K75GS2	B72207S0750K211	S2	1500
SIOVS007K95GS2	B72207S0950K211	S2	1500
SIOVS007S95AGS2	B72207S0950S212	S2	1500
SIOV-S07K115GS2	B72207S0111K211	S2	1500
SIOV-S07K130GS2	B72207S0131K211	S2	1500
SIOV-S07K140GS2	B72207S0141K211	S2	1500
SIOV-S07K150GS2	B72207S0151K211	S2	1500
SIOV-S07K175GS2	B72207S0171K211	S2	1500
SIOV-S07K230GS3	B72207S0231K311	S3	1000
SIOV-S07K250GS3	B72207S0251K311	S3	1000
SIOV-S07K275GS3	B72207S0271K311	S3	1000
SIOV-S07K300GS3	B72207S0301K311	S3	1000
SIOV-S07K385GS3	B72207S0381K311	S3	1000
SIOV-S07K420GS3	B72207S0421K311	S3	1000
SIOV-S07K440GS3	B72207S0441K311	S3	1000
SIOV-S07K460GS3	B72207S0461K311	S3	1000

Leaded Varistors
Taping

Type	Ordering code	Crimp style	Pieces/reel III
Type series SIOV-S10, straight leads $e = 7,5$			
SIOV-S10K11G5	B72210S0110K151	—	1500
SIOV-S10K14G5	B72210S0140K151	—	1500
SIOV-S10K17G5	B72210S0170K151	—	1500
SIOV-S10K20G5	B72210S0200K151	—	1500
SIOV-S10K25G5	B72210S0250K151	—	1500
SIOV-S10K30G5	B72210S0300K151	—	1500
SIOV-S10K35G5	B72210S0350K151	—	1500
SIOV-S10K40G5	B72210S0400K151	—	1500
SIOV-S10K50G5	B72210S0500K151	—	1500
SIOV-S10K60G5	B72210S0600K151	—	1500
SIOV-S10K75G5	B72210S0750K151	—	1500
SIOV-S10K95G5	B72210S0950K151	—	1500
SIOV-S10K115G5	B72210S0111K151	—	1500
SIOV-S10K130G5	B72210S0131K151	—	1500
SIOV-S10K140G5	B72210S0141K151	—	1500
SIOV-S10K150G5	B72210S0151K151	—	1500
SIOV-S10K175G5	B72210S0171K151	—	1500
SIOV-S10K230G5	B72210S0231K151	—	1000
SIOV-S10K250G5	B72210S0251K151	—	1000
SIOV-S10K275G5	B72210S0271K151	—	1000
SIOV-S10K300G5	B72210S0301K151	—	1000

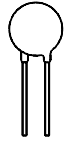
Type	Ordering code	Crimp style	Pieces/reel I
Type series SIOV-S10, crimped leads $e = 5,0$			
SIOV-S10K11GS4R5	B72210S0110K412	S4	1500
SIOV-S10K14GS4R5	B72210S0140K412	S4	1500
SIOV-S10K17GS4R5	B72210S0170K412	S4	1500
SIOV-S10K20GS4R5	B72210S0200K412	S4	1500
SIOV-S10K25GS4R5	B72210S0250K412	S4	1500
SIOV-S10K30GS4R5	B72210S0300K412	S4	1500
SIOV-S10K35GS4R5	B72210S0350K412	S4	1500
SIOV-S10K40GS4R5	B72210S0400K412	S4	1500
SIOV-S10K50GS4R5	B72210S0500K412	S4	1500
SIOV-S10K75GS4R5	B72210S0750K412	S4	1500
SIOV-S10K95GS4R5	B72210S0950K412	S4	1500

Leaded Varistors
Taping

Type	Ordering code	Crimp style	Pieces/reel I
Type series SIOV-S10, crimped leads $e = 5,0$ (continued)			
SIOV-S10K115GS4R5	B72210S0111K412	S4	1500
SIOV-S10K130GS4R5	B72210S0131K412	S4	1500
SIOV-S10K140GS4R5	B72210S0141K412	S4	1500
SIOV-S10K150GS4R5	B72210S0151K412	S4	1500
SIOV-S10K175GS4R5	B72210S0171K412	S4	1500
SIOV-S10K230GS3R5	B72210S0231K312	S3	1500
SIOV-S10K250GS3R5	B72210S0251K312	S3	1500
SIOV-S10K275GS3R5	B72210S0271K312	S3	1000
SIOV-S10K300GS3R5	B72210S0301K312	S3	1000

Type	Ordering code	Crimp style	Pieces/reel III
Type series SIOV-S10, crimped leads $e = 7,5$			
SIOV-S10K11G5S5	B72210S0110K551	S5	1500
SIOV-S10K14G5S5	B72210S0140K551	S5	1500
SIOV-S10K17G5S5	B72210S0170K551	S5	1500
SIOV-S10K20G5S5	B72210S0200K551	S5	1500
SIOV-S10K25G5S5	B72210S0250K551	S5	1500
SIOV-S10K30G5S5	B72210S0300K551	S5	1500
SIOV-S10K35G5S5	B72210S0350K551	S5	1500
SIOV-S10K40G5S5	B72210S0400K551	S5	1500
SIOV-S10K50G5S5	B72210S0500K551	S5	1500
SIOV-S10K60G5S5	B72210S0600K551	S5	1500
SIOV-S10K75G5S5	B72210S0750K551	S5	1500
SIOV-S10K95G5S5	B72210S0950K551	S5	1500
SIOV-S10K115G5S5	B72210S0111K551	S5	1500
SIOV-S10K130G5S5	B72210S0131K551	S5	1500
SIOV-S10K140G5S5	B72210S0141K551	S5	1500
SIOV-S10K150G5S5	B72210S0151K551	S5	1500
SIOV-S10K175G5S5	B72210S0171K551	S5	1500
SIOV-S10K230G5S5	B72210S0231K551	S5	1000
SIOV-S10K250G5S5	B72210S0251K551	S5	1000
SIOV-S10K275G5S5	B72210S0271K551	S5	1000
SIOV-S10K300G5S5	B72210S0301K551	S5	1000

SIOV-S10K320 ... 460G.S. upon request

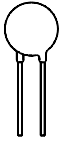

Leaded Varistors

Taping

Type	Ordering code	Crimp style	Pieces/reel III
Type series SIOV-S14, straight leads $e = 7,5$			
SIOV-S14K11G5	B72214S0110K151	—	1500
SIOV-S14K14G5	B72214S0140K151	—	1500
SIOV-S14K17G5	B72214S0170K151	—	1500
SIOV-S14K20G5	B72214S0200K151	—	1500
SIOV-S14K25G5	B72214S0250K151	—	1500
SIOV-S14K30G5	B72214S0300K151	—	1500
SIOV-S14K35G5	B72214S0350K151	—	1500
SIOV-S14K40G5	B72214S0400K151	—	1500
SIOV-S14K50G5	B72214S0500K151	—	1500
SIOV-S14K60G5	B72214S0600K151	—	1500
SIOV-S14K75G5	B72214S0750K151	—	1500
SIOV-S14K95G5	B72214S0950K151	—	1500
SIOV-S14K115G5	B72214S0111K151	—	1500
SIOV-S14K130G5	B72214S0131K151	—	1500
SIOV-S14K140G5	B72214S0141K151	—	1500
SIOV-S14K150G5	B72214S0151K151	—	1500
SIOV-S14K175G5	B72214S0171K151	—	1500
SIOV-S14K230G5	B72214S0231K151	—	1000
SIOV-S14K250G5	B72214S0251K151	—	1000
SIOV-S14K275G5	B72214S0271K151	—	1000
SIOV-S14K300G5	B72214S0301K151	—	1000
Type series SIOV-S14, crimped leads $e = 7,5$			
SIOV-S14K11G5S5	B72214S0110K551	S5	1500
SIOV-S14K14G5S5	B72214S0140K551	S5	1500
SIOV-S14K17G5S5	B72214S0170K551	S5	1500
SIOV-S14K20G5S5	B72214S0200K551	S5	1500
SIOV-S14K25G5S5	B72214S0250K551	S5	1500
SIOV-S14K30G5S5	B72214S0300K551	S5	1500
SIOV-S14K35G5S5	B72214S0350K551	S5	1500
SIOV-S14K40G5S5	B72214S0400K551	S5	1500
SIOV-S14K50G5S5	B72214S0500K551	S5	1500
SIOV-S14K60G5S5	B72214S0600K551	S5	1500
SIOV-S14K75G5S5	B72214S0750K551	S5	1500
SIOV-S14K95G5S5	B72214S0950K551	S5	1500

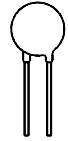

Leaded Varistors

Taping / Lock-In Crimps

Type	Ordering code	Crimp style	Pieces/reel III
Type series SIOV-S14, crimped leads $e = 7,5$ (continued)			
SIOV-S14K115G5S5	B72214S0111K551	S5	1500
SIOV-S14K130G5S5	B72214S0131K551	S5	1500
SIOV-S14K140G5S5	B72214S0141K551	S5	1500
SIOV-S14K150G5S5	B72214S0151K551	S5	1500
SIOV-S14K175G5S5	B72214S0171K551	S5	1500
SIOV-S14K230G5S5	B72214S0231K551	S5	1000
SIOV-S14K250G5S5	B72214S0251K551	S5	1000
SIOV-S14K275G5S5	B72214S0271K551	S5	1000
SIOV-S14K300G5S5	B72214S0301K551	S5	1000

SIOV-S14K320 ... 460G.(S.) upon request

SIOV-S20K11 ... 320G.(S.) upon request

SIOV-S..K ... E2G.(S.)
 SIOV-S20K ... E3G.(S.)
 SIOV-Q14K ... G.(S.)
 SIOV-Q20K ... G.(S.)

} taping according
 } to the versions
 } of the standard program
 } upon request

Lock-in crimps

These crimp styles provide automatic lock-in function on the printed circuit board, for facilitated assembly.

Crimp style S9 (for lead spacing $e = 5$):

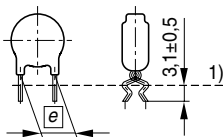

1) Seating plane in according to IEC 60717
VAR0413-V

Layout recommendation

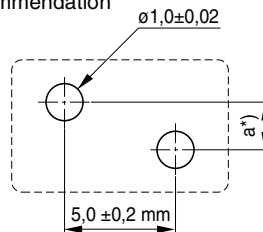

*) Set-off "a" depending on voltage ratings

VAR0421-M

Recommended PCB thickness: $1,5 + 0,2$ mm

Example: SIOV-S07K275S9

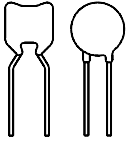

Leaded Varistors

Taping / Lock-In Crimps / Trimmed Leads

Crimp style S11 (for lead spacing $e = 7,5$):

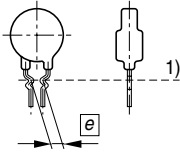

1) Seating plane according to IEC 60717

VAR0429-Y

Layout recommendation

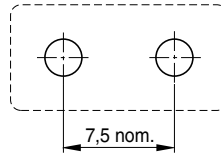

VAR0414-D

Recommended PCB thickness: 1,6 +/- 0,14 mm

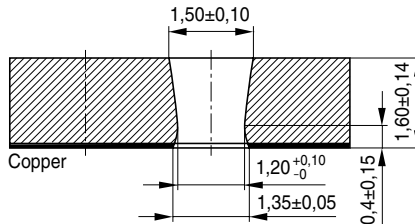

VAR0549-S

Recommended hole pattern

Example: SIOV-S14K275S11

Trimmed leads

Varistors with cut leads available upon request.

Lead length tolerances:

Straight leads	+/- 1,0 mm
Crimped leads	+/- 0,8 mm
Min. lead length	3,5 mm

Examples: SIOV-S07K275M4,5: straight leads, lead length $4,5 \pm 1,0$ mm
 SIOV-S14K275S5M4,5: crimpstyle 5, lead length $4,5 \pm 0,8$ mm

Herausgegeben von EPCOS AG

Unternehmenskommunikation, Postfach 80 17 09, 81617 München, DEUTSCHLAND

☎ ++49 89 636 09, FAX (0 89) 636-2 26 89

© EPCOS AG 2002. Vervielfältigung, Veröffentlichung, Verbreitung und Verwertung dieser Broschüre und ihres Inhalts ohne ausdrückliche Genehmigung der EPCOS AG nicht gestattet.

Bestellungen unterliegen den vom ZVEI empfohlenen Allgemeinen Lieferbedingungen für Erzeugnisse und Leistungen der Elektroindustrie, soweit nichts anderes vereinbart wird.

Diese Broschüre ersetzt die vorige Ausgabe.

Fragen über Technik, Preise und Liefermöglichkeiten richten Sie bitte an den Ihnen nächstgelegenen Vertrieb der EPCOS AG oder an unsere Vertriebsgesellschaften im Ausland. Bauelemente können aufgrund technischer Erfordernisse Gefahrstoffe enthalten. Auskünfte darüber bitten wir unter Angabe des betreffenden Typs ebenfalls über die zuständige Vertriebsgesellschaft einzuholen.

Published by EPCOS AG

Corporate Communications, P.O. Box 80 17 09, 81617 Munich, GERMANY

☎ ++49 89 636 09, FAX (0 89) 636-2 26 89

© EPCOS AG 2002. Reproduction, publication and dissemination of this brochure and the information contained therein without EPCOS' prior express consent is prohibited.

Purchase orders are subject to the General Conditions for the Supply of Products and Services of the Electrical and Electronics Industry recommended by the ZVEI (German Electrical and Electronic Manufacturers' Association), unless otherwise agreed.

This brochure replaces the previous edition.

For questions on technology, prices and delivery please contact the Sales Offices of EPCOS AG or the international Representatives.

Due to technical requirements components may contain dangerous substances. For information on the type in question please also contact one of our Sales Offices.