

# Current Sensing Chip Resistors

## Type SL/TSL Resistor

ISO 9001:2000  
TS-16949

### 1. Scope

This specification applies to current sensing chip resistors (SL/TSL) produced by KOA Corporation. Products with lead-free terminations meet EU-RoHS requirements. Pb located in glass material, electrode and resistor element is exempt per Annex 1, exemption 5 of EU directive 2005/95/EC

### 2. Type Designation

The type designation shall be in the following form:

#### New Type

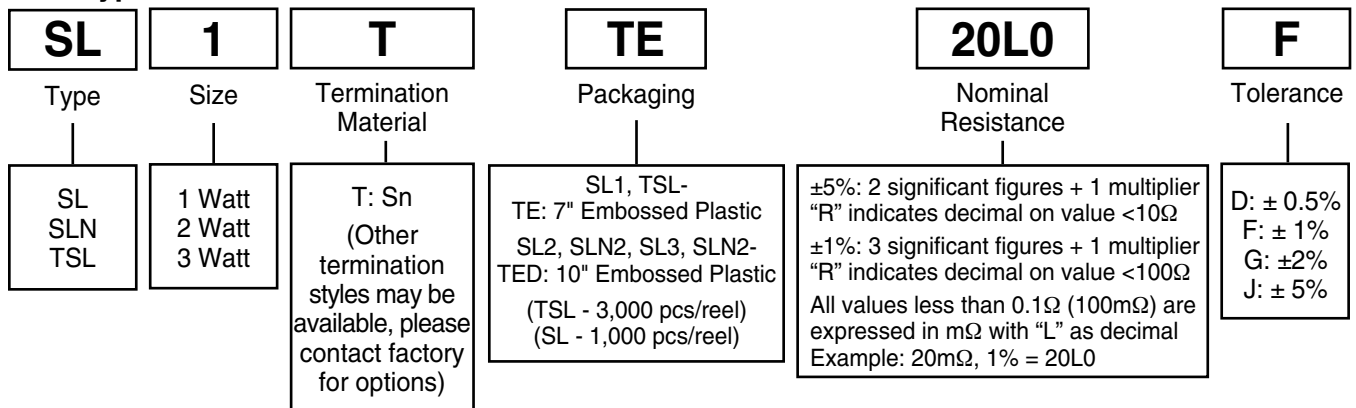

### 3. Standard Applications

Part Designation	Power Rating	T.C.R. (ppm/°C) Max.	Resistance Range	Resistance Tolerance E-24*	Absolute Maximum Working Voltage	Absolute Maximum Overload Voltage	Operating Temperature Range
SL1	1W	±180: R=<13mΩ ±100: R=>15mΩ	10mΩ - 1MΩ	(D: ±0.5%)	200V	400V	-55°C to +180°C
			5mΩ - 1MΩ	(F: ±1%)			
			3mΩ, 4mΩ	(G: ±2%)			
			3mΩ ~ 22MΩ	(J: ±5%)			
SL2	2W	±180: R=<10mΩ ±100: R=>11mΩ	10mΩ - 1MΩ	(D: ±0.5%)	500V	1000V	
			5mΩ ~ 1MΩ	(F: ±1%)			
			3mΩ, 4mΩ	(G: ±2%)			
3mΩ - 22MΩ	(J: ±5%)						
SLN2	2W	±110: R<10mΩ ±75: R=>10mΩ	5mΩ - 200mΩ	(D: ±0.5%) (F: ±1%) (J: ±5%)	—	—	
SL3	3W	±180: R=<10mΩ ±100: R=>11mΩ	10mΩ - 100mΩ	(D: ±0.5%)	√P•R	√P•R	
			5mΩ - 100mΩ	(F: ±1%) (J: ±5%)			
TSL1	1W	±180: R=<13mΩ ±100: R=>15mΩ	10mΩ - 100mΩ	(D: ±0.5%)	√P•R	√P•R	
			5mΩ - 100mΩ	(F: ±1%) (J: ±5%)			

\* 3m, 4m, 5m, 6m, 7m, 8m, 9m resistance values also available

## 4. Dimensions and Structure

### 4-1 Dimensions

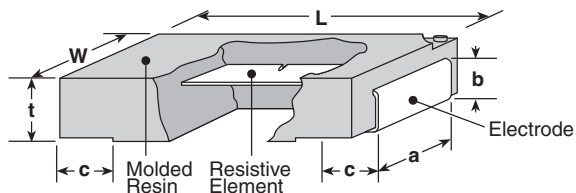

### 4-2 Structure

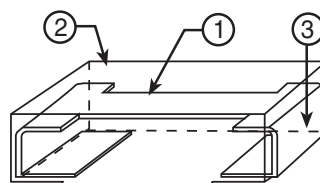

- ① Resistive Element  
Metal Plate: SL1 ≤ 100 mΩ, SL2 ≤ 360 mΩ, SL3  
Thick Film: SL1 > 100 mΩ, SL2 > 360 mΩ
- ② Flameproof Molded Epoxy Case with UL94V-0 Flammability Rating
- ③ End Termination with Tin/Lead Solder Plating

Size Code	Dimensions inches (mm)					
	L	W	t	a	b	c
SL1	.248±.012 (6.3±0.3)	.122±.008 (3.1±0.2)	.075±.008 (1.9±0.2)	.094±.008 (2.4±0.2)	.047±.012 (1.2±0.3)	.047±.012 (1.2±0.3)
SL2	.453±.012 (11.5±0.3)	.276±.008 (7.0±0.2)	.098±.008 (2.5±0.2)	.197±.008 (5.0±0.2)	.067±.02 (1.7±0.5)	.102±.02 (2.6±0.5)
<b>NEW</b> SLN2	.453±.012 (11.5±0.3)	.276±.008 (7.0±0.2)	.094±.008 (2.4±0.2)	.217±.008 (5.5±0.2)	.063±.008 (1.6±0.2)	.100±.016 (2.55±0.4)
SL3	.453±.012 (11.5±0.3)	.276±.008 (7.0±0.2)	.098±.008 (2.5±0.2)	.197±.008 (5.0±0.2)	.067±.02 (1.7±0.5)	.102±.02 (2.6±0.5)
TSL1	.248±.012 (6.3±0.3)	.122±.008 (3.1±0.2)	.039±.008 (1.0±0.2)	.094±.008 (2.4±0.2)	.028±.008 (0.7±0.2)	.047±.012 (1.2±0.3)

## 5. Rating Derating Curve

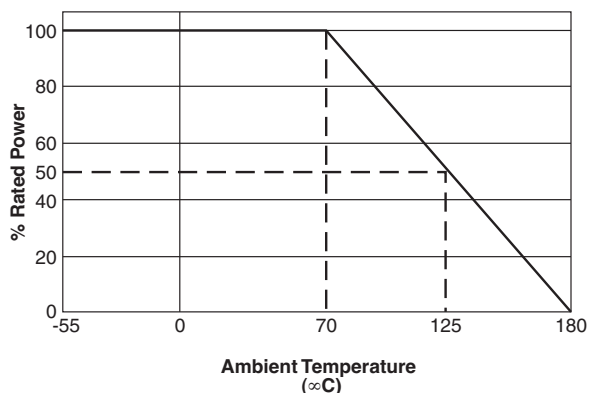

### 5-1 Rating SL3

For temperature in excess of 110°C, the load shall be derated in accordance with the following figure.

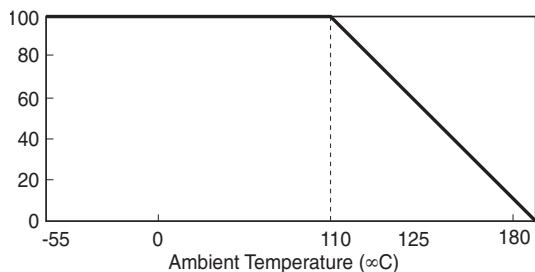

## Surface Temperature Rise

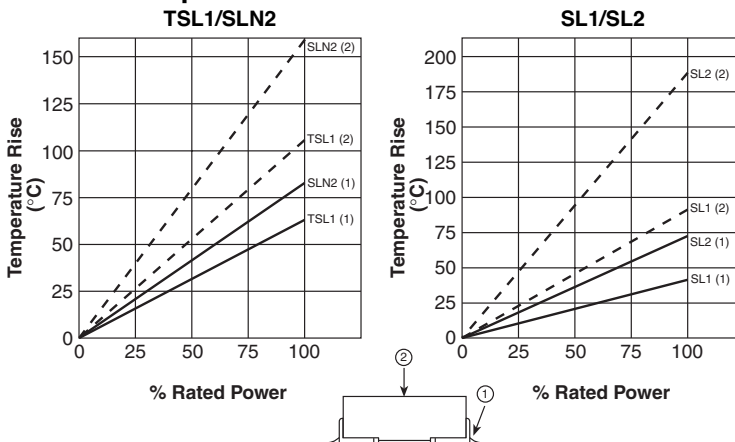

### 5-2 Voltage Rating

Resistors shall have a rated direct-current (DC) continuous working voltage or approximate sine-wave root-mean-square (RMS) alternating-current (AC) continuous working voltage at commercial-line frequency and waveform corresponding to the power rating, as determined from the following formula:

$$E = \sqrt{P \times R}$$

Where:  
 E = Rated voltage (V)  
 P = Rated power (W)  
 R = Nominal resistance (Ω)

## 6. Characteristics

### 6-4 High Frequency Characteristics

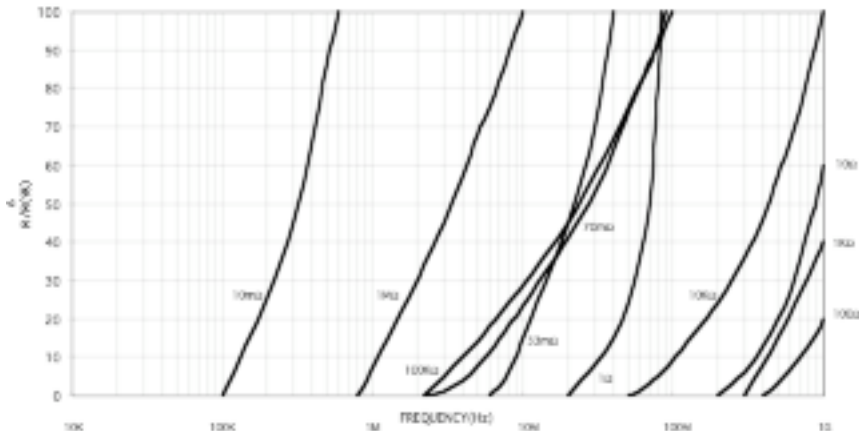

### 6-1 Electrical Characteristics

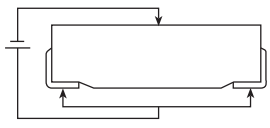
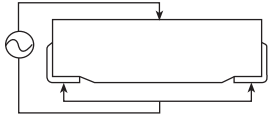
No.	Item	Requirement	Test Method (JIS C 5202)
1	Resistance	Within specified tolerance	JIS C 5202 5.1 Measured at 25°C
2	Temperature coefficient of resistance	1 W ±180: R=<14.7 mΩ ±100: R=>15 mΩ	JIS C 5202 5.2 + 25°C / +125°C
		2 W ±180: R=<10.7 mΩ ±100: R=>11 mΩ	
		3 W ±180: R=<10.7 mΩ ±100: R=>11 mΩ	
3	Short time overload	± 1.0% maximum	5* times rated power for 5 seconds 10 Watts (SL3 only)
4	Intermittent overload	± 5.0% maximum	Rated voltage x 3.0* 1 sec. ON/25 seconds OFF 1,000 cycles 18 Watts 1 second ON/125 seconds OFF 1,000 cycles (SL3 only)
5	Insulation Resistance	10,000 MΩ minimum	Surface center to terminations D. C 500V 
6	Dielectric Withstanding Voltage	± 0.5% maximum No short, burning or arcing	A. C 500V 60 sec. 

\* Since temperature rise of this product are affected by the circuit board size, materials, peripheral heat-producing components, etc. check that the solder fillet part temperature after mounting is less than the solder melting point (180°C) in operating condition and that the package surface is 200°C or less. Also, please install radiating patterns and carefully design the pattern width with respect to the load current so that the above temperatures can be maintained.

## 6-2 Mechanical Characteristics

No.	Item	Requirement	Test Method (JIS C 5202)
1	Resistance to Soldering Heat	± 1.0% maximum	MIL-R55342 π 4.7.7, 260°C for 10 seconds
2	Solderability	95% of the terminal should be covered with new solder	Immerse in solder at 230°C ± 5°C for 3 ± 0.5 seconds
3	Vibration	± 0.5% maximum	6.3 Condition A Each direction/2 hours
4	Resistance to Solvents	No visual and mechanical damage	6.9

## 6-3 Environmental Characteristics

Dimensions in inches (mm)

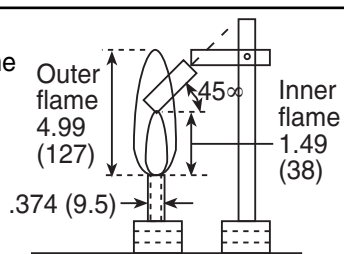
No.	Item	Requirement	Test Method (JIS C 5202)
1	Damp Heat	± 2.0% maximum No visual damage	7.9 40°C ± 2°C; 90 ~ 95% RH; 1,000 hours
2	Moisture Resistance	± 2.0% maximum No evidence of damage	MIL-STD-202, Method 103, 40°C, 90-95% RH, 1000 hours
3	Load Life (Rated load)	± 2.0% maximum No visual damage	MIL-STD-202, Method 108, 70°C, 1000 hours @ RCWV, 1.5 hr ON, 0.5 hr OFF
4	Temperature Cycling	± 1.0% maximum No mechanical damage	30 minutes @ -55°C, 15 minutes @ +25°C, 30 minutes @ +125°C, 15 minutes @ +25°C, 5 cycles
5	Flammability	Incombustible	7.12 3.1 in flame/out flame 15 sec./15 sec. 5 cycles 

## 7. Taping

### 7-1 Dimensions of Carrier Tape

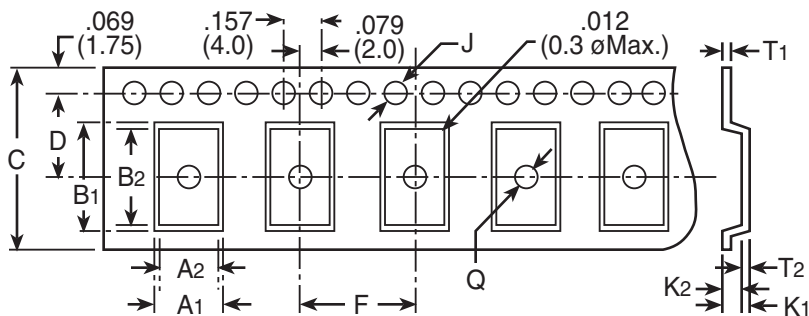

Dimensions in inches (mm)

	A1	A2	B1	B2	C	D	F	J	K1	K2	Q	T1	T2
TSL	.134 (3.4±0.1)	.125 (3.2±0.1)	.260 (6.6±0.1)	.244 (6.2±0.1)	.472 (12.0±0.2)	.216 (5.5±0.1)	.157 (4.0±0.1)	.059 (1.5± <sup>0.1</sup> <sub>0.0</sub> )	.051 (1.3±0.1)	.043 (1.1 ± 0.1)	.059 (1.5± <sup>0.1</sup> <sub>0.0</sub> )	.010 (0.25±0.05)	.008 (0.20±0.05)
SL-1	.142 (3.6±0.1)	.134 (3.4±0.1)	.267 (6.8±0.1)	.252 (6.4±0.1)	.472 (12.0±0.2)	.216 (5.5±0.1)	.315 (8.0±0.1)	.059 (1.5± <sup>0.1</sup> <sub>0.0</sub> )	.092 (2.35±0.1)	.085 (2.15±0.1)	.059 (1.5± <sup>0.1</sup> <sub>0.0</sub> )	.010 (0.25±0.05)	.008 (0.20±0.05)
SL-2	.303 (7.7±0.1)	.291 (7.4±0.1)	.480 (12.2±0.1)	.469 (11.9±0.1)	.945 (24.0±0.2)	.452 (11.5±0.1)	.472 (12.0±0.1)	.059 (1.55± <sup>0.5</sup> <sub>0.3</sub> )	.134 (3.4±0.1)	.126 (3.2±0.1)	.081 (2.05± <sup>0.5</sup> <sub>0.5</sub> )	.010 (0.25±0.05)	.008 (0.20±0.05)
SL-3	.303 (7.7±0.1)	.291 (7.4±0.1)	.480 (12.2±0.1)	.469 (11.9±0.1)	.945 (24.0±0.2)	.452 (11.5±0.1)	.472 (12.0±0.1)	.059 (1.5± <sup>0.1</sup> <sub>0.0</sub> )	.122 (3.1±0.1)	.110 (2.8±0.1)	.059 (1.5± <sup>0.1</sup> <sub>0.0</sub> )	.016 (0.40±0.05)	.012 (0.30±0.05)
SLN-2	.303 (7.7±0.1)	—	.480 (12.2±0.1)	—	.472 (12.0±0.1)	—	.472 (12.0±0.2)	—	.122 (3.1±0.1)	—	—	—	—

### 7-2 Taped Configuration

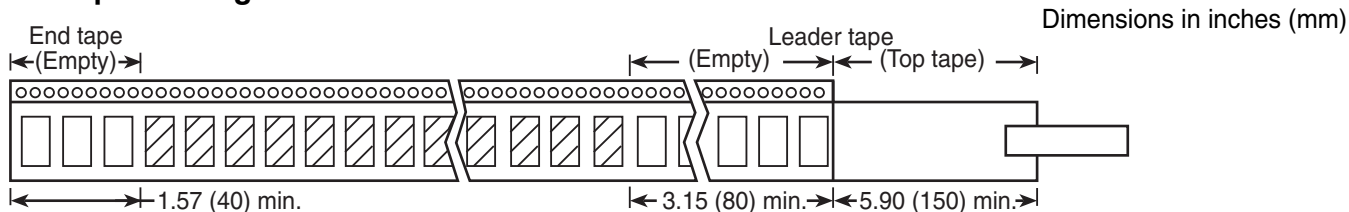

## 7-3 Reel Dimensions

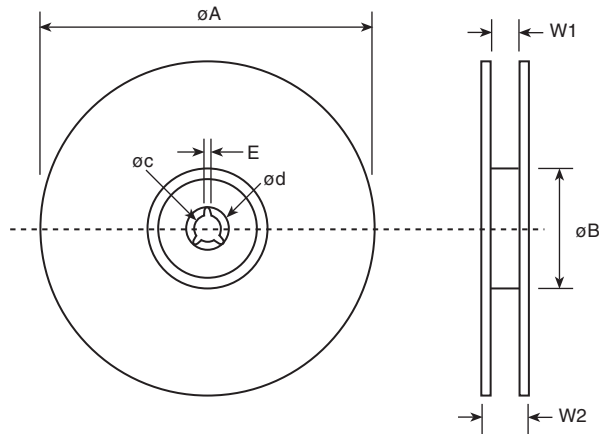

Dimensions in inches (mm)

	$\phi A$	$\phi B$	$\phi C$	$\phi D$	E	W1	W2	Qty/ Reel
<b>TSL</b>	7.08 (180 ± 3.0)	2.36 (60 ± 1.0)	.511 (13.0 ± 0.2)	.826 (21.0 ± 0.8)	.079 (2.0 ± 0.2)	.511 (13.0 ± 0.3)	.606 (15.4 ± 1.0)	3,000
<b>SL-1</b>	7.08 (180 ± 3.0)	2.36 (60 ± 1.0)	.511 (13.0 ± 0.2)	.826 (21.0 ± 0.8)	.079 (2.0 ± 0.2)	.511 (13.0 ± 0.3)	.606 (15.4 ± 1.0)	1,000
<b>SL-2</b>	10.0 (255 ± 3.0)	3.15 (80 ± 1.0)	.511 (13.0 ± 0.2)	.984 (25.0 ± 1.0)	.079 (2.0 ± 0.5)	1.00 (25.5 ± 2.0)	1.18 (30.0 ± 1.0)	1,000
<b>SL-3</b>								

## 8. Recommended Land Pattern TSL1, SL1 & SL2

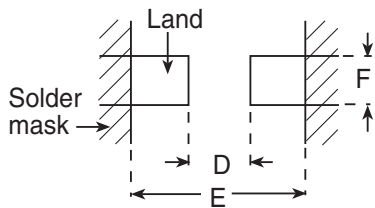

Dimensions in inches (mm)

	D	E	F
TSL1	.133 (3.4)	.315 (8.0)	.118 (3.0)
SL1	.133 (3.4)	.315 (8.0)	.118 (3.0)
SL2	.213 (5.4)	.591 (15.0)	.157 (4.0)
SL3	.213 (5.4)	.591 (15.0)	.157 (4.0)
SLN-2	.197 (5.0)	.591 (15.0)	.197 (5.0)

## 8-1 Body and Marking

Body color	Black
Marking color	White
Marking items	Resistance value and tolerance