

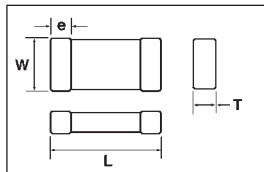

Quick Reference

| Series | Features | Page |
|--------------------------------------|----------------------------------|------|
| Multilayer Chip Type | | |
| SNPO | 0402-3035 Case Sizes 6.3 - 4KV | 4 |
| SX7R | 0402-3035 Case Sizes 6.3 - 4KV | 5 |
| SY5V | 0402-3035 Case Sizes 10 - 500V | 6 |
| SZ5U | 0402-3035 Case Sizes 10 - 1KV | 7 |
| Multilayer Radial Leaded Type | | |
| RNPO | 2.5/5.0mm Lead Spacing 25 - 100V | 8 |
| RX7R | 2.5/5.0mm Lead Spacing 25 - 100V | |
| RY5V | 2.5/5.0mm Lead Spacing 25 - 63V | |
| RZ5U | 2.5/5.0mm Lead Spacing 25 - 63V | |
| Multilayer Axial Leaded Type | | |
| ANPO | 5mm Body Length 50 - 100V | 9 |
| AX7R | 5mm Body Length 50 - 100V | |
| AZ5U | 5mm Body Length 50 - 100V | |

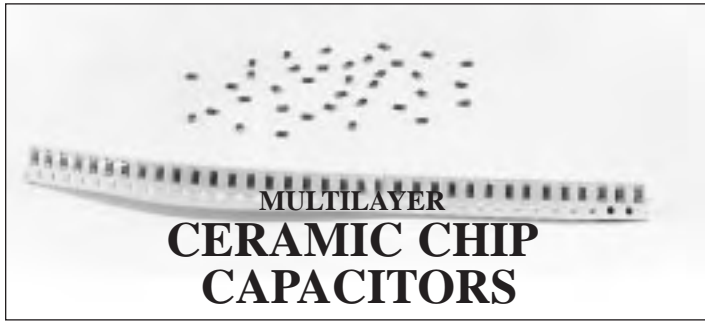

Tolerance on Dimensions
"L" and "W": ± 0.35mm(0.014")max.

CASE DIMENSIONS AND TOLERANCES

| Case Code | Dimensions mm(inches) | | | |
|-----------|-----------------------|-------------|-------------|-------------|
| | L | W | T max. | e |
| 0402 | 1.00(0.040) | 0.50(0.020) | 0.55(0.022) | 0.20(0.008) |
| 0603 | 1.60(0.063) | 0.80(0.032) | 0.90(0.035) | 0.30(0.012) |
| 0805 | 2.03(0.080) | 1.27(0.050) | 1.27(0.050) | 0.50(0.020) |
| 1206 | 3.20(0.125) | 1.60(0.063) | 1.35(0.053) | 0.50(0.020) |
| 1210 | 3.20(0.125) | 2.50(0.098) | 1.60(0.063) | 0.50(0.020) |
| 1808 | 4.50(0.177) | 2.03(0.800) | 1.80(0.071) | 0.50(0.020) |
| 1812 | 4.50(0.177) | 3.20(0.125) | 2.20(0.087) | 0.60(0.027) |
| 2220 | 5.70(0.224) | 5.00(0.197) | 2.80(0.110) | 0.65(0.026) |
| 2225 | 5.70(0.224) | 6.30(0.248) | 2.80(0.110) | 0.65(0.026) |
| 3012 | 7.60(0.299) | 3.20(0.125) | 5.70(0.224) | 0.70(0.028) |
| 3035 | 7.60(0.299) | 8.90(0.350) | 6.30(0.248) | 0.70(0.028) |

"L" & "W" tolerances: ±0.35mm(0.014)max.

STANDARD PACKAGING QUANTITIES

| Case Code | Bulk | Tape & Reel |
|-----------|------------|----------------|
| 0402 | 10000 pcs. | 10000 pcs/reel |
| 0603 | 5000 pcs. | 4000 pcs/reel |
| 0805 | 5000 pcs. | 4000 pcs/reel |
| 1206 | 5000 pcs. | 4000 pcs/reel |
| 1210 | 5000 pcs. | 4000 pcs/reel |
| 1808 | 1000 pcs | 1000 pcs/reel |
| 1812 | 1000 pcs | 1000 pcs/reel |
| 2220 | 1000 pcs | 1000 pcs/reel |
| 2225 | 1000 pcs | 1000 pcs/reel |
| 3012 | 1000 pcs | 500 pcs/reel |
| 3035 | 1000 pcs | 500 pcs/reel |

Special package quantity available upon request and factory approval.

Example below indicates : SNPO series, 470 pF, 5%, 50 Volt, Tape/Reel packed, 0805 case size.

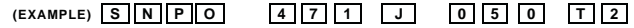

Series ————

Series Code: SNPO, SX7R, SZ5U, SY5V.
Note: SNPO indicates COG(NPO) dielectric

Capacitance ————

3 Digit Capacitance Code (per EIA Standard):
First Two Digits Represent Significant Figures of Capacitance in pF.
Third Digit Indicates Number of Zeros
For Values Below 10 pF, R replaces second digit to indicate a decimal point.
Example: 471 = 470 pF., 1R5 = 1.5 pF.

Tolerance ————

Capacitance Tolerance Code:
Capacitance Tolerance Code: ± .25 pF ± .5 pF ± 1% ± 2% ± 5% ± 10% ± 20% -20 + 80%

Rated Voltage ————

3 Digit Voltage Code:
Rated Voltage(V): 6.3 10 16 25 50 100 200 250 500 1000 2000 3000 4000
Code: 006 010 016 025 050 100 200 250 500 1KV 2KV 3KV 4KV

Packing Code ————

Code: T (Tape & Reel), B (Bulk)

Case Code ————

Case Code: 0 1 2 3 4 5 6 7 8 9 10
Case Size: 0402 0603 0805 1206 1210 1808 1812 2220 2225 3012 3035

Tape/Reel & Packaging Specifications

Taping Dimensions

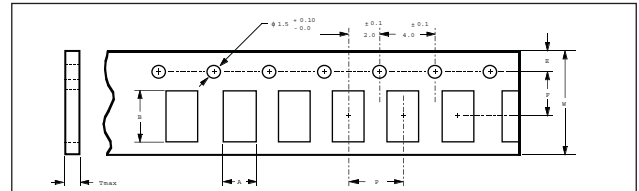

| SIZE CODE | A | B | W | F | E | P | Tmax |
|-----------|--------------------|--------------------|--------------------|--------------------|--------------------|--------------------|-------------|
| 0402 | ±0.1 mm or ±0.004" | ±0.1 mm or ±0.004" | ±0.3 mm or ±0.012" | ±0.1 mm or ±0.004" | ±0.1 mm or ±0.004" | ±0.1 mm or ±0.004" | 1.7 (0.067) |
| 0603 | 0.7 (0.028) | 1.3 (0.051) | 8.0 (0.315) | 3.5 (0.138) | 1.75 (0.069) | 4.0 (0.157) | 1.7 (0.067) |
| 0805 | 1.7 (0.067) | 2.4 (0.094) | 8.0 (0.315) | 3.5 (0.138) | 1.75 (0.069) | 4.0 (0.157) | 1.7 (0.067) |
| 1206 | 2 (0.079) | 3.6 (0.142) | 8.0 (0.315) | 3.5 (0.138) | 1.75 (0.069) | 4.0 (0.157) | 1.7 (0.067) |
| 1210 | 2.8 (0.110) | 3.7 (0.147) | 8.0 (0.315) | 3.5 (0.138) | 1.75 (0.069) | 4.0 (0.157) | 1.7 (0.067) |
| 1808 | 2.4 (0.094) | 4.9 (0.193) | 12.0 (0.472) | 3.5 (0.138) | 1.75 (0.069) | 4.0 (0.157) | 1.7 (0.067) |
| 1812 | 3.6 (0.142) | 4.9 (0.193) | 12.0 (0.472) | 3.5 (0.138) | 1.75 (0.069) | 4.0 (0.157) | 1.7 (0.067) |
| 2220 | 5.2 (0.205) | 6.0 (0.236) | 12.0 (0.472) | 3.5 (0.138) | 1.75 (0.069) | 4.0 (0.157) | 1.7 (0.067) |
| 2225 | 6.6 (0.260) | 6.0 (0.236) | 12.0 (0.472) | 3.5 (0.138) | 1.75 (0.069) | 4.0 (0.157) | 1.7 (0.067) |

Reel Dimensions

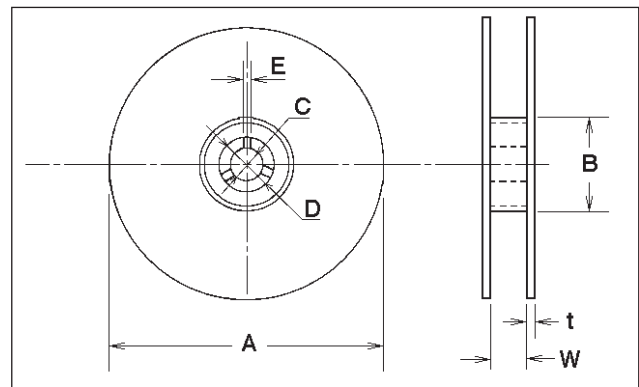

Reel Dimensions in Millimeters

| A | B | C | D | E | W | t |
|-----------|-----------|-----------|-----------|----------|---------------|----------|
| ø178 ±2.0 | ø50 min. | 13.0 ±0.5 | 21.0 ±0.8 | 2.0 ±0.8 | 8.8/12.8 ±1.5 | 2.0 ±0.5 |
| ø330 ±2.0 | ø100 min. | 13.0 ±0.5 | 21.0 ±0.8 | 2.0 ±0.8 | 8.8/12.8 ±1.5 | 2.0 ±0.6 |

Reel Dimensions in Inches

| A | B | C | D | E | W | t |
|-----------|-----------|-----------|------------|-----------|-----------------|------------|
| ø7 ±0.08 | ø2.0 min. | 5.0 ±0.02 | 0.83 ±0.03 | 0.08 ±0.3 | 0.35/0.50 ±0.06 | 0.08 ±0.02 |
| ø13 ±0.08 | ø4.0 min. | 5.0 ±0.3 | 0.83 ±0.03 | 0.08 ±0.3 | 0.35/0.50 ±0.06 | 0.08 ±0.02 |

Reliability and Test Conditions

| Parameter | Specification | Test Method |
|--|--|--|
| Capacitance | Within tolerance specified in the part number | Class(I) C≤1000 pF: 1 MHz. ±10% 0.5 to 5 V rms |
| Dissipation Factor (Tan δ and Q) | Class(I) C<30 pF: Q≥400+20xC C30 pF: Q>1000 Class(II) X7R: DF≤3%, Z5U: DF≤3%, Y5V: DF≤5% | C>1000 pF: 1 KHz. ±10% 1.0 ±0.2 V rms Class(II) 1 KHz. ±10%, 1.0 ±0.2 V rms |
| Insulation Resistance (IR) | C≤50,000 IR: >10 G Ohms C≤50,000 IR: >500 Ohms.F | Apply rated voltage for 60 seconds at room temperature and normal humidity (70% max.) |
| Dielectric Withstanding Voltage | There shall be no evidence of damage or flash over during the test. | Apply rated voltage (Class I) or 2.5 x rated voltage (Class II) to both terminations for 5 seconds. Charge and discharge current are less hat 50 mA. |
| Termination Adherence | No mechanical damage | After soldering capacitor on the glass-epoxy PWB, 50 gms of steady pull is applied in direction of arrow for 10 seconds. (See Figure 1) |
| Bend Strength | No mechanical damage | After soldering capacitor on the glass-epoxy PWB, 2 mm of bending shall be applied for 10 seconds as shown in the drawing. (See Figure 2) |
| Life Test (High Temperature Loading test) - Capacitance Change | Class(I): No more than ±3% or ±0.3 pf which ever is more. Class(II): X7R: ±10% max. Z5U, Y5V: ±30% max. | Apply 2 x rated voltage at maximum operating temperature for 1000 hours. The surge current shall not exceed 50 mA. After this, the samples shall be kept in room temperature for 24 hours (Class I) or 48 hours (class II) and then measured for the parameters indicated. |
| Life Test (High Temperature Loading test) - DF or Q | Class(I) C<10 pF: Q≥200+10xC 10 pF≤ C < 30 pF Q≥275+2xC: C>30 pF: Q>350 Class(II) X7R: DF≤5% Z5U & Y5V: DF≤7.5% | |
| Life Test (High Temperature Loading test) - IR | 1000 M Ohms or 50 Ohms.F whichever is less | |

Figure 1

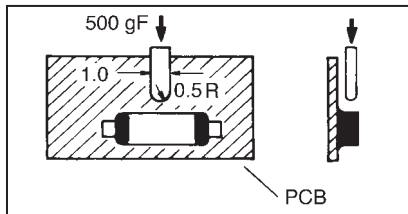
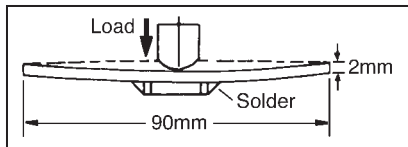

Figure 2



| Parameter | Specification | Test Method |
|---|--|---|
| Moisture Resistance Test - Capacitance change | Class(I): No more than ±5% or ±0.5 pf which ever is more. Class(II): X7R: ±10% max. Z5U & Y5V: ±30% max. | The capacitor shall be subjected to 40 °C and 90 to 95% RH for 500 hours. After this, samples shall be |
| Moisture Resistance Test - Q or DF | Class(I) C<10 pF: Q≥200+10xC 10 pF≤ C < 30 pF Q≥275+2xC: C≥30 pF: Q≥350 Class(II) X7R: DF≤5% Z5U & Y5V: DF≤7.5% | kept in room temperature for 24 hrs. (Class I) or 48 hrs. (Class II), and them shall be measured (Class I) or 48 hours (Class II) and then measured for the parameters indicated. |
| Moisture Resistance Test - IR | 1000 M Ohms or 50 Ohms.F whichever is less | |
| Humidity Load Test - Capacitance change | Class(I): No more than ±7.5% or ±0.75 pf which ever is more. Class(II): X7R: ±12.5% max. Z5U, Y5V: ±30% max. | The capacitor shall be subjected to rated voltage at 40 °C and 90 to 95 % RH for 500 hours. Surge current shall not exceed 50 mA. After this, samples shall be kept in room temperature for 24 hrs. (Class I) or 48 hours (Class II), and them shall be measured (Class I) or 48 hours (Class II) and then measured for the parameters indicated. |
| Humidity Load Test Q or DF | Class(I) C<30 pF: Q≥ 100+3xC C ≥ 30 pF: Q≥200 Class(II) X7R: DF≤5% Z5U & Y5V: DF≤7.5% | |
| Humidity Load Test - IR | 500 M Ohms or 25 Ohms.F whichever is less | |
| Temperature Cycling Test - Capacitance change | Class(I): No more than ±2.5% or ±0.25 pf which ever is more. Class(II): X7R: ±7.5% max. Z5U, Y5V: ±20% max. | Perform 5 cycles as follows: 1. Room temperature dwell for 15 minutes. 2. Minimum operating temperature dwell for 30 minutes. |
| Temperature Cycling Test - Q or DF | Parts to meet the initial specifications | 3. Room temperature dwell for 30 minutes. |
| Temperature Cycling Test - IR | Parts to meet the initial specifications | 4. Maximum operating temperature dwell for 30 minutes. After the above testing condition, samples shall be kept in room temperature for 24 hrs. (Class I) or 48 hours (Class II), and them shall be measured (Class I) or 48 hours (class II) and then measured for the parameters indicated. |
| Solderability | Termination area shall be at least 75% covered with a new solder coating. There shall be no crack and ceramic exposure of terminated surface due to melting. | The capacitors are completely immersed for 10 ±0.5 seconds in the molten solder with a temperature of 260±5°C solder. Cladding material of outer-electrode: Sn (~100%) |
| Resistance to Solder Heat Test - Capacitance Change | No more than ±2.5% or ±0.25 pf which ever is more. Class(II): X7R: ±7.5% max. Z5U, Y5V: ±20% max. | The capacitors are completely immersed for 10 ±1.0 seconds in the molten solder with a temperature of 270±5°C solder. Preheat before immersion, 1. 80 to 100 °C for 2 minutes 2. 150 to 180 °C for 2 minutes |
| Resistance to Solder Heat Test - Q or DF | Parts to meet the initial specifications | |
| Resistance to Solder Heat Test - IR | Parts to meet the initial specifications | The capacitance measurement shall be made after the samples have been kept at room temperature for 24 hours. |

Class II Dielectric Code Explanation

| First symbol (a letter) | Low temperature requirement | Second symbol (a number) | High Temperature requirement | Third Symbol (a letter) | MAX. Capacitance change over temperature |
|-------------------------|-----------------------------|--------------------------|------------------------------|-------------------------|--|
| Z | +10 deg. C | 2 | +45 deg. C | A | +1.0% |
| Y | -30 deg. C | 4 | +65 deg. C | B | +/- 1.5% |
| X | -55 deg. C | 5 | +85 deg. C | C | +/- 2.2% |
| | | 6 | +105 deg. C | D | +/- 3.3% |
| | | 7 | +125 deg. C | E | +/- 4.7% |
| | | | | F | +/- 7.5% |
| | | | | P | +/- 10.0% |
| | | | | R | +/- 15.0% |
| | | | | S | +/- 22.0% |
| | | | | T | +22%, -33% |
| | | | | U | +22%, -56% |
| | | | | V | +22%, -82% |

SNPO Series

APPLICATION:

The SNPO series has a high Q, low K temperature compensating type of capacitance dielectric with stable electrical properties under varying voltage, temperature, frequency and time conditions. The series is suitable for circuits requiring low loss, circuits with pulse, timing circuits and for tuning applications. Typically used in R/F, microwave, and other communications equipment. Frequently designed in precision industrial controls, process control and test & measurement instrumentation. Because of its wide range of temperature stability, often used in automotive and quality audio applications.

FEATURES:

- Very low temperature coefficient
- Stable electrical characteristics
- High capacitance and miniature size
- Low and high voltage options
- Available in bulk and tape & reel packaging
- Consistent dimensions and surface finish
- Nickel barrier terminations

GENERAL SPECIFICATIONS:

Operating temperature: -55 to +125 °C
Temperature coefficient: ±30ppm per °C
Capacitance tolerance: ±5%, <10pF ±.25pF or ±.5pF standard, ±10% optional
Capacitance range: .47pF to .1uF
Voltage range: 6.3V to 4KV DC
Dielectric withstanding voltage: 2 times the working VDC for 5 seconds
Case code range: 0402 to 3035
Note: See Reliability and Test Conditions page for more specifications

Note: Extended capacitance range values, optional case codes, special tolerances may be available based on factory approval.

| COG(NPO) DIELECTRIC CAPACITANCE RANGE Tolerance: (J), <5pF: ±.25pF(C), ≥5pF<10pF: ±.5pF(D) standards. Optional: (K) | | | | | | | | | | | |
|---|---------------------------|------------|------------|------------|-------------|-----------|---------------|-----------|---------------|--------------|---------------|
| Voltage(DC) | Voltage/Case Code Options | | | | | | | | | | |
| | 0402 | 0603 | 0805 | 1206 | 1210 | 1808 | 1812 | 2220 | 2225 | 3012 | 3035 |
| 6.3V | | 18-820pF | | | | | | | | | |
| 10V | | 12-680pF | | | | | | | | | |
| 16V | .62-470pF | 2-680pF | | | | | | | | | |
| 25V | .47-560pF | .47-1000pF | .47-3300pF | .47-4700pF | 560pF-.01uF | | 1000pF-.015uF | | 1000pF-.047uF | | 1000pF-.1uF |
| 50V | .47-330pF | .47-1000pF | .47-2200pF | .47-4700pF | 10pF-.015uF | 10-3300pF | 10pF-.022uF | | 1000pF-.022uF | | 1000pF-.047uF |
| 100V | | .47-1000pF | .47-2200pF | .47-3300pF | 10-6800pF | 10-4700pF | 10pF-.01uF | | 10pF-.01uF | 470pF-.022uF | 1000pF-.033uF |
| 200V | | .47-1000pF | .47-1500pF | .47-2200pF | 10-3300pF | 10-4700pF | 10-5600pF | | 10pF-.012uF | 470pF-.01uF | |
| 250V | | | .47-820pF | .47-2200pF | 10-3300pF | 10-4700pF | 10-5600pF | | 10pF-.012uF | 470pF-.01uF | |
| 500V | | | .47-560pF | | .47-2700pF | 10-2700pF | 10-4700pF | 10-4700pF | 10-6800pF | 470-6800pF | .01-.022uF |
| 1KV | | | | .47-680pF | 10-1000pF | 10-4700pF | 10-2200pF | | 10-2700pF | 470-2700pF | |
| 2KV | | | | .47-470pF | 10-470pF | 10-2200pF | 10-1000pF | | 10-1000pF | 470-1000pF | |
| 3KV | | | | | | 10-1000pF | 10-1000pF | | 10-680pF | 470-1000pF | |
| 4KV | | | | | | 10-470pF | 10-330pF | | 10-560pF | 470-1000pF | |

COG / NPO is a dielectric with stable electrical properties under varying voltage, temperature, frequency and time.

This dielectric has the least value of temperature coefficient. The temperature coefficient characteristics is illustrated in Figure 1.1 Figure 1.2 illustrates the variation pattern of Dissipation Factor with respect to temperature.

The DC Voltage coefficient and AC Voltage coefficient are illustrated in Figures 1.3 and 1.4 respectively.

COG (NPO) Characteristic Graphs

FIGURE 1.1

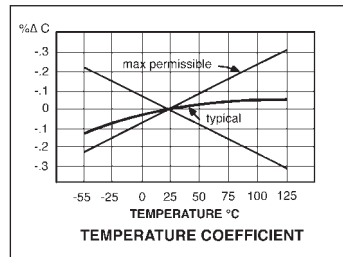

FIGURE 1.2

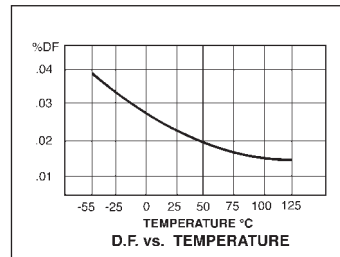

FIGURE 1.3

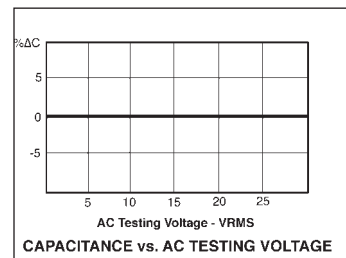
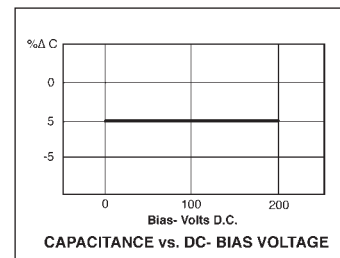

FIGURE 1.4



SX7R Series

APPLICATION:

The SX7R series has a moderate K temperature compensating type of capacitance dielectric and is temperature stable. It shows moderate change in electrical properties under changing temperature, voltage and frequency conditions. The series is suitable for by-passing, coupling, and frequency discriminating circuit applications.

Typically used in computer and data processing products and equipment. It offers relatively stable characteristics at a lower cost consideration than the SNPO series. This series has higher capacitance range options than the SNPO range.

FEATURES:

- Stable electrical characteristics
- High capacitance and miniature size
- Available in bulk and tape & reel packaging
- Low and high voltage options
- Consistent dimensions and surface finish
- Nickel barrier terminations

GENERAL SPECIFICATIONS:

Operating temperature: -55 to +125 °C
Temperature coefficient: ±15% value change
Capacitance tolerance: ±10% standard, ±20% optional
Capacitance range: 10pF to 4.7uF
Voltage range: 6.3V to 4KV DC
Dielectric withstanding voltage: 2 times the working VDC for 5 seconds
Case code range: 0402 to 3035

Note: See Reliability and Test Conditions page for more specifications

Note: Extended capacitance range values, optional case codes, special tolerances may be available based on factory approval.

| Voltage(DC) | X7R DIELECTRIC CAPACITANCE RANGE Tolerance: (K) standard Optional: (M) | | | | | | | | | | |
|-------------|--|--------------|-------------|-------------|--------------|--------------|--------------|------|--------------|--------------|-----------|
| | Voltage/Case Code Options | | | | | | | | | | |
| | 0402 | 0603 | 0805 | 1206 | 1210 | 1808 | 1812 | 2220 | 2225 | 3012 | 3035 |
| 6.3V | | .001-.0068uF | .0082-1uF | 1-4.7uF | | | | | | | |
| 10V | 150pF-.033uF | .12-.22uF | .1-.47uF | 1-4.7uF | | | | | | | |
| 16V | 150pF-.033uF | .12-.22uF | .1-.47uF | 1000pF-1uF | 10pF-2.2uF | | | | | | |
| 25V | 150pF-.022uF | .01-.1uF | 220pF-1uF | 1000pF-1uF | 10pF-2.2uF | | .01-.47uF | | .01-1uF | | .01-2.2uF |
| 50V | 150pF-.01uF | 150pF-.056uF | 10pF-1uF | 330pF-1uF | 10pF-2uF | | .01-.33uF | | .01-1uF | | .01-2.2uF |
| 100V | | 100pF-.01uF | 10pF-1uF | 10pF-.33uF | 10pF-.22uF | 150pF-.22uF | 150pF-.47uF | | 150pF-1.2uF | 6800pF-1uF | .01-1uF |
| 200V | | 100pF-.068uF | 10pF-.022uF | 10pF-.068uF | 10pF-.1uF | 150pF-.1uF | 150pF-.22uF | | 150pF-.47uF | 6800pF-1uF | |
| 250V | | 100-4700pF | 10pF-.022uF | 10pF-.047uF | 10pF-.1uF | 150pF-.1uF | 150pF-.15uF | | 150pF-.47uF | 6800pF-1uF | |
| 500V | | | 10pF-.01uF | 10pF-.026uF | 150pF-.068uF | 150pF-.047uF | 150pF-.1uF | | 150pF-.39uF | 1000pF-1uF | |
| 1KV | | | | 10pF-.01uF | 150pF-.015uF | 150pF-.022uF | 150pF-.027uF | | 150pF-.056uF | .0027-.047uF | |
| 2KV | | | | 10pF-.027uF | 150pF-.01uF | 150pF-.01uF | 150pF-.01uF | | 150pF-.047uF | .001-.022uF | |
| 3KV | | | | | | 150-4700pF | 150-2200pF | | 150-6800pF | 1000-6800pF | |
| 4KV | | | | | | 150-2000pF | 150-1500pF | | 150-3900pF | .001-.01uF | |

X7R is a moderately stable dielectric under changing temperature, voltage and frequency conditions.

This dielectric has moderate value of temperature coefficient. The temperature coefficient characteristics is illustrated in Figure 2.1. Figure 2.2 illustrates the variation pattern of Dissipation Factor with respect to temperature.

The DC Voltage coefficient and AC Voltage coefficient are illustrated in Figure 2.3 and 2.4 respectively.

X7R Characteristic Graphs

FIGURE 2.1

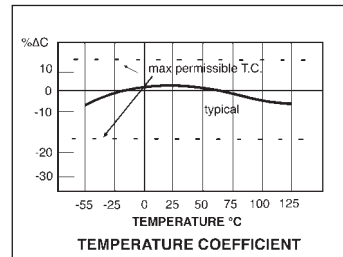

FIGURE 2.2

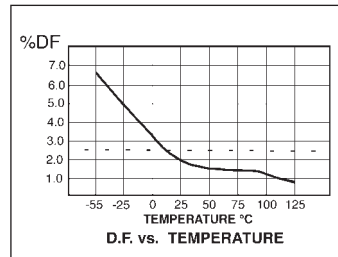

FIGURE 2.3

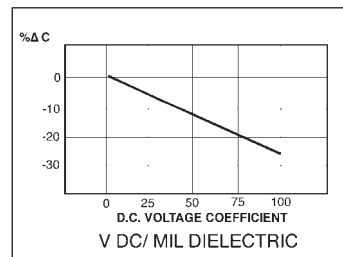
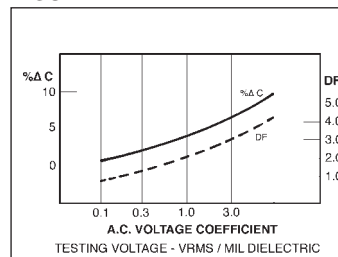

FIGURE 2.4



SY5V Series

APPLICATION:

The SY5V series has a relatively high K temperature compensating type of capacitance dielectric. The electrical properties can vary widely under changing temperature, voltage, and time conditions. They are suitable for all general purpose applications where higher capacitance values are required. Best when used in non-critical, room temperature stable conditions with low DC bias. Suitable for de-coupling applications in stable temperature conditions.

FEATURES:

- High capacitance values
- Miniature size
- Low and high voltage options
- Available in bulk and tape & reel packaging
- Low cost for high capacitance
- Consistent dimensions and surface finish
- Nickel barrier terminations

GENERAL SPECIFICATIONS:

Operating temperature: -30 to +85 °C
Temperature coefficient: -82% to +22% value change over operating temperature
Capacitance tolerance: ±20% standard, -20%/ +80% optional
Capacitance range: 2200pF to 10uF
Voltage range: 10V to 500V DC
Dielectric withstanding voltage: 2 times the working VDC for 5 seconds
Case code range: 0402 to 3035

Note: See Reliability and Test Conditions page for more specifications

Note: Extended capacitance range values, optional case codes, special tolerances may be available based on factory approval.

| Y5V DIELECTRIC CAPACITANCE RANGE Tolerance: (M) standard Optional: (Z) | | | | | | | | | | | |
|--|---------------------------|---------------|------------|------------|-------------|--------------|-----------|------|-----------|--------------|---------|
| Voltage(DC) | Voltage/Case Code Options | | | | | | | | | | |
| | 0402 | 0603 | 0805 | 1206 | 1210 | 1808 | 1812 | 2220 | 2225 | 3012 | 3035 |
| 6.3V | | | | | | | | | | | |
| 10V | .01-.1uF | .27-1uF | .27-3.3uF | | | | | | | | |
| 16V | .01-.1uF | .27-1uF | .27-3.3uF | .27-6.8uF | .1-10uF | | | | | | |
| 25V | .01-.056uF | .047-.47uF | .01-2.2uF | .01-3.3uF | .1-10uF | | .15-3.3uF | | .68-4.7uF | | 1-10uF |
| 50V | .01-.033uF | .01-.22uF | .01-.68uF | .01-2.2uF | .1-3.3uF | | .15-2.2uF | | .68-3.3uF | | 1-6.8uF |
| 100V | | 2200pF-.068uF | .01-.22uF | 4700pF-1uF | .22-2.2uF | .01-.82uF | .01-2.2uF | | .01-2uF | 6800pF-1.5uF | |
| 200V | | 4700pF-.068uF | .01-.056uF | .01-.47uF | .01-.39uF | 4700pF-.39uF | .01-.47uF | | .01-.68uF | 6800pF-1uF | |
| 250V | | | .01-.056uF | .01-.47uF | .01-.39uF | 4700pF-.39uF | .01-.47uF | | .01-.68uF | 6800pF-1uF | |
| 500V | | | | | .012-.047uF | | | | | | |
| 1KV | | | | | | | | | | | |
| 2KV | | | | | | | | | | | |
| 3KV | | | | | | | | | | | |
| 4KV | | | | | | | | | | | |

Y5V Characteristic Graphs

The temperature coefficient characteristics of Y5V is illustrated in Figure 3.1. Figure 3.2 illustrates the variation pattern of Dissipation Factor with respect to temperature. The DC Voltage coefficient and aging pattern are illustrated in Figure 3.3 and 3.4 respectively.

FIGURE 3.1

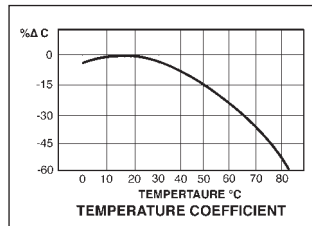

FIGURE 3.2

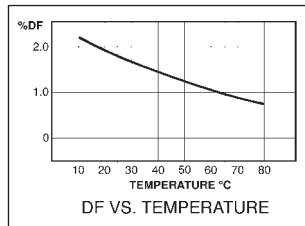

FIGURE 3.3

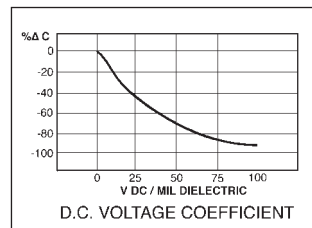
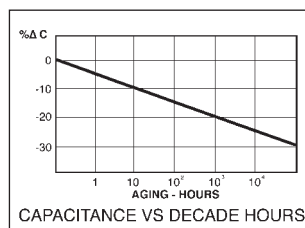

FIGURE 3.4



SZ5U Series

APPLICATION:

The SZ5U series has a high K temperature compensating type of capacitance dielectric. The electrical properties of this dielectric changes considerably under changing temperature, voltage and time conditions. High capacitance values are available for general purpose applications. Well suited for filtering, transient suppression blocking, and charge storage requirements.

FEATURES:

- High capacitance values
- Miniature size
- Low and high voltage options
- Available in bulk and tape & reel packaging
- Low cost for high capacitance
- Consistent dimensions and surface finish
- Nickel barrier terminations

GENERAL SPECIFICATIONS:

Operating temperature: +10 to +85 °C
Temperature coefficient: -56% to +22% value change over operating temperature
Capacitance tolerance: ±20% standard, -20%/ +80% optional
Capacitance range: 1000pF to 10uF
Voltage range: 10V to 1KV DC
Dielectric withstanding voltage: 2 times the working VDC for 5 seconds
Case code range: 0603 to 3035
Note: See Reliability and Test Conditions page for more specifications

Note: Extended capacitance range values, optional case codes, special tolerances may be available based on factory approval.

| Z5U DIELECTRIC CAPACITANCE RANGE Tolerance: (M) Standard Optional: (Z) | | | | | | | | | | | |
|--|---------------------------|-----------|-----------|-------------|--------------|------|-----------|------|-----------|------|---------|
| Voltage(DC) | Voltage/Case Code Options | | | | | | | | | | |
| | 0402 | 0603 | 0805 | 1206 | 1210 | 1808 | 1812 | 2220 | 2225 | 3012 | 3035 |
| 6.3V | | | | | | | | | | | |
| 10V | | .18-.22uF | .18-.47uF | | | | | | | | |
| 16V | | .18-.22uF | .18-.47uF | .18-2.2uF | .01-4.7uF | | | | | | |
| 25V | | .01-.22uF | .01-1uF | .01-2.2uF | .01-4.7uF | | .15-3.3uF | | .68-4.7uF | | 1-10uF |
| 50V | | .01-.1uF | .01-.68uF | .01-1uF | .01-2.2uF | | .15-2.2uF | | .68-3.3uF | | 1-6.8uF |
| 100V | | | .01-.22uF | .01-.47uF | .01-1uF | | .1-2.2uF | | | | |
| 200V | | | | .01-.1uF | .01-.22uF | | | | | | |
| 250V | | | | | | | | | | | |
| 500V | | | | .01-.047uF | .01-.1uF | | | | | | |
| 1KV | | | | 1000-4700pF | 1000pF-.01uF | | | | | | |
| 2KV | | | | | | | | | | | |
| 3KV | | | | | | | | | | | |
| 4KV | | | | | | | | | | | |

Z5U Characteristic Graphs

FIGURE 4.1

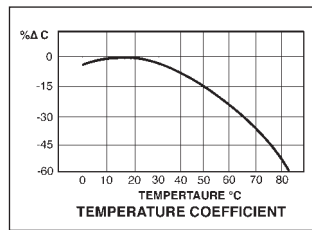
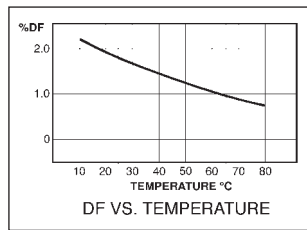

FIGURE 4.2



The temperature coefficient characteristics of Z5U is illustrated in Figure 4.1. Figure 4.2 illustrates the variation pattern of Dissipation Factor with respect to temperature. The DC Voltage coefficient and aging pattern are illustrated in Figure 4.3 and 4.4 respectively.

FIGURE 4.3

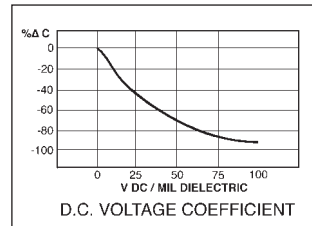
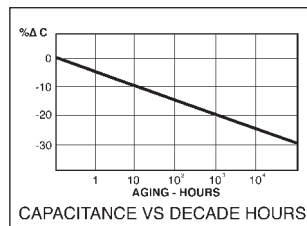

FIGURE 4.4



Introduction:

MULTILAYER CERAMIC LEADED CAPACITORS

Radial Epoxy coated multilayer ceramic capacitors available in popular COG(NPO), X7R, Y5V and Z5U dielectrics. Ideal for industrial and general purpose electronic applications. These capacitors are available in both Bulk and Tape & Reel packing for automatic insertion.

| Series Specifications: | COG/NPO | X7R | Y5V | Z5U |
|--|-------------------------|-------------------------|-------------------------|-------------------------|
| Temperature Range in °C: | -55 to +125 | -55 to +125 | -30 to +85 | +10 to +85 |
| Dissipation Factor % @25°C & 1KHz: | 0.25 max | 3.0 max | 6.0 max | 4.0 max |
| Insulation Resistance @25°C: (minimum of) | 1 G Ohm or 100 Ohm F | 1 G Ohm or 100 Ohm F | 1 G Ohm or 100 Ohm F | 1 G Ohm or 100 Ohm F |
| Overload Voltage(25°C) 5 seconds max: | 2x rated voltage | 2x rated voltage | 2x rated voltage | 2x rated voltage |
| Temperature Coefficient: | ±30ppm/°C | ±15% chg. | -82 to +22% chg. | -56 to +22% chg. |
| Tolerance options: | J(5%), K(10%) | K(10%), M(20%) | M(20%), Z(-20 to +80%) | M(20%), Z(-20 to +80%) |

Radial Leaded Series

Features

- COG(NPO) & X7R dielectrics in 25, 50 and 100 Volt rating. Y5V and Z5U in 25, 50, and 63 Volt rating.
- Radial configuration with choice of 2 standard lead spacing.
- Available in Bulk and Tape & Reel Packing (EIA Standard).

Style A : s = 2.5 ± 0.5mm

Style B : s = 5.0 ± 0.5mm

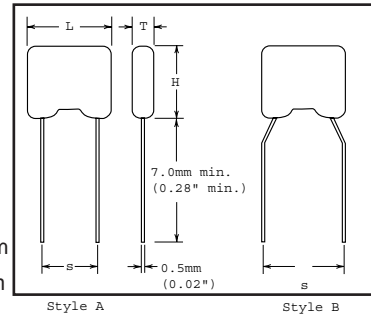

CASE CODE/ CAPACITANCE, VOLTAGE, LEAD STYLE OPTIONS TABLE

| Case Code | Size Dimensions | | | Voltage | Capacitance Range | | | | Lead Style |
|-----------|-----------------|------------|------------|----------|-------------------|---------------|-----------|-----------|------------|
| | L | H | T | | COG(NPO) | X7R | Y5V | Z5U | |
| 0805 | 4.1mm max. | 3.8mm max. | 3.2mm max. | 25V | 10-3300pF | 220pF-1uF | .01-.1uF | .01-.22uF | A,B |
| | | | | 50V | 10-2200pF | 220pF-.1uF | .01-.68uF | .01-.1uF | A,B |
| | | | | 100V | 10-1000pF | 220pF-.068uF | | | A,B |
| 1206 | 5.5mm max. | 6.0mm max. | 4.5mm max. | 25V | 10-4700pF | 1000pF-1uF | .01-1.2uF | .01-.33uF | A,B |
| | | | | 50V | 10-4700pF | 1000pF-.1uF | .01-1uF | .01-.22uF | A,B |
| | | | | 100V | 10-3300pF | 1000pF-.068uF | | | A,B |
| 1210 | 6.5mm max. | 7.5mm max. | 5.0mm max. | 25V | 560pF-.01uF | 1000pF-.33uF | .1-2.2uF | .1-1uF | B |
| | | | | 50V(63V) | 560pF-6800pF | 1000pF-2uF | .1-2.2uF | .1-1uF | B |
| | | | | 100V | 560pF-4700pF | 1000pF-1uF | | | B |
| 1812 | 8.5mm max. | 7.5mm max. | 5.0mm max. | 25V | 1000pF-.015uF | .01-.47uF | .15-3.3uF | .68-2.2uF | B |
| | | | | 50V(63V) | 1000pF-.01uF | .01-.33uF | .15-3.3uF | .68-2.2uF | B |
| | | | | 100V | 1000-6800pF | .01-.15uF | | | B |
| 2225 | 10.5mm max. | 10mm max. | 6.5mm max. | 25V | 1000pF-.022uF | .01-1uF | 1-4.7uF | 1.5-3.3uF | B |
| | | | | 50V(63V) | 1000pF-.022uF | .01-1uF | 1-4.7uF | 1.5-3.3uF | B |
| | | | | 100V | 1000pF-.01uF | .01-.47uF | | | B |

Note: Extended capacitance range values; special voltages, tolerances, lead spacing and forming may be available on factory approval.

PART NUMBERING EXPLANATION

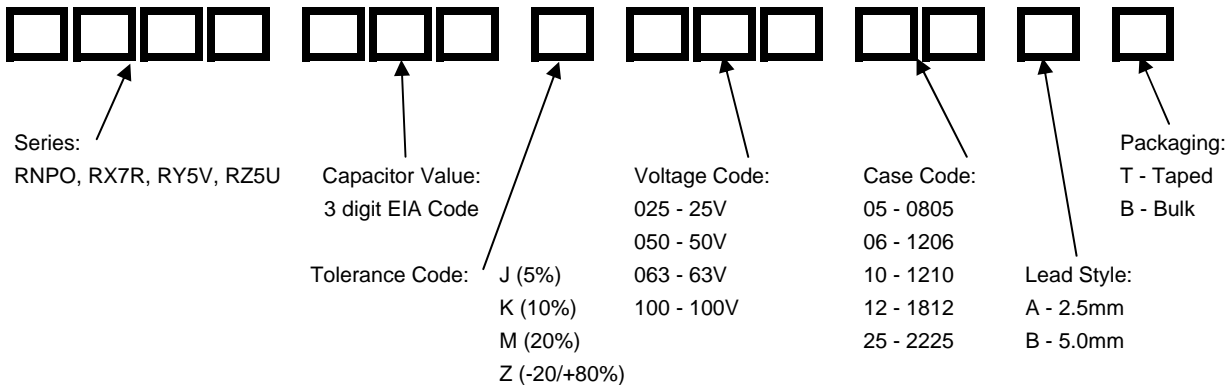

MULTILAYER CERAMIC LEADED CAPACITORS

Introduction:

Axial Epoxy coated multilayer ceramic capacitors available in popular COG(NPO), X7R and Z5U dielectrics. Ideal for industrial and general purpose electronics applications. These capacitors are available in both Bulk and Tape & Reel packing for automatic insertion.

Series Specifications:

| | NPO | X7R | Z5U |
|--|-------------------------|-------------------------|-------------------------|
| Temperature Range in °C: | -55 to +125 | -55 to +125 | +10 to +85 |
| Dissipation Factor % @25°C & 1KHz: | 0.25 max | 2.5 max | 3.0 max |
| Insulation Resistance @ 25°C : (minimum of) | 1 G Ohm or 100 Ohm F | 1 G Ohm or 100 Ohm F | 1 G Ohm or 100 Ohm F |

Axial Leaded SERIES

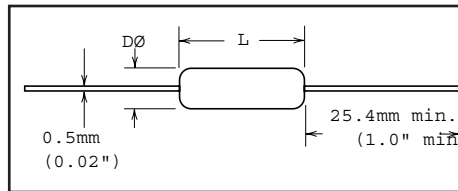

Axial Series ANPO

| Rated Voltage VDC | Dielectric | Temperature Coefficient | Capacitance | | Dimensions | |
|-------------------|------------|-------------------------|-------------|-------------------|------------------|------------------|
| | | | Range pF | Tolerance | L max. | D max. |
| 50 | COG (NPO) | ±30 ppm °C | 10 to 750 | J(±5%), K(±10%) | 5.0 mm 0.200" | 3.0 mm 0.120" |

Axial Series AX7R

| Rated Voltage VDC | Dielectric | Temperature Coefficient | Capacitance | | Dimensions | |
|-------------------|------------|-------------------------|--------------|--------------------|------------------|------------------|
| | | | Range pF | Tolerance | L max. | D max. |
| 50 | X7R | ±15% | 560 to 15000 | K(±10%), M(±20%) | 5.0 mm 0.200" | 3.0 mm 0.120" |

Axial Series AZ5U

| Rated Voltage VDC | Dielectric | Temperature Coefficient | Capacitance | | Dimensions | |
|-------------------|------------|-------------------------|----------------|----------------------------|------------------|------------------|
| | | | Range pF | Tolerance | L max. | D max. |
| 50 | Z5U | +22 to -56% | 1000 to 100000 | M(±20%) Z(-20 to +80%) | 5.0 mm 0.200" | 3.0 mm 0.120" |

PART NUMBERING

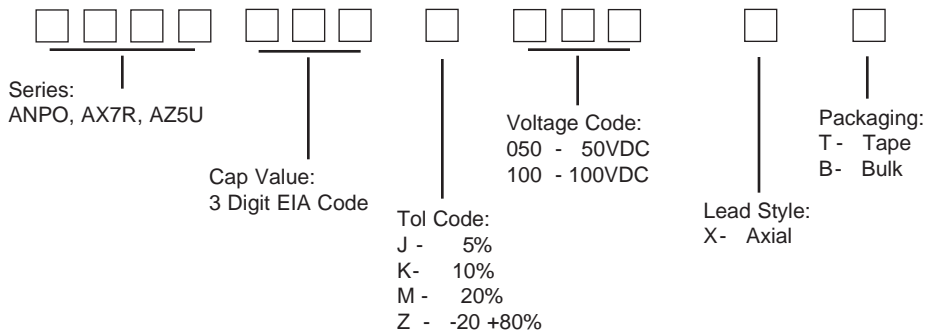

SCY1, SCY2 Series Safety Recognized Ceramic Capacitor

| Specifications | |
|-------------------------------|--|
| Operating Temperature | -25°C to +85°C |
| Capacitance Range | 100pF to 10000pF (Y2 series) 100pF to 4700pF (Y1 series) |
| Capacitance Tolerance | K=± 10%, M=± 20% |
| Rated voltage | 250VAC, 400VAC |
| Temperature Coefficient | ± 10% for Y5P, +30% to -80% for Y5V (Y2 series) ± 10% for Y5P, +20% to -55% for Y5U (Y1 series) |
| Dissipation Factor (tand) | Y5P: 2.5% max at 25°C and 1KHz, 1±0.2 Vrms Y5V: 5% max at 25°C and 1KHz, 1±0.2 Vrms (Y2 series) Y5U: 2.5% max at 25°C and 1KHz, 1±0.2 Vrms (Y1 series) |
| Insulation Resistance at 25°C | 10000Mohm at 500VDC for 1 minute |
| Dielectric Strength | 2600VAC for 60 seconds (Rated voltage: 400VAC) -Y2 series 4000VAC for 60 seconds (Rated voltage: 400VAC) -Y1 series |

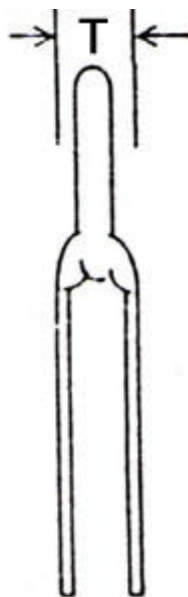
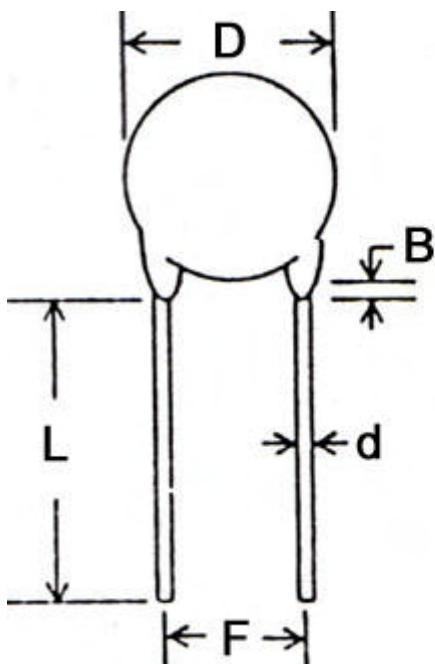

Dimensions and Tolerance:

B = 3.0 mm max

d = 0.60 mm ±0.05 mm

F = 7.5 or 9.5 ±0.8 mm (Y2 Series)

F = 9.5 ±0.8 mm (Y1 Series)

L = 5 ~ 25 mm

SCY1 Series

- Special size or items on request.
- Tolerance Dimension ± 0.5 mm.

| T.C. | CAP. | TOL. | D | Dimension (mm) | T |
|---------------------|--------|---------|----|----------------|---|
| ± 10% (Y5P) | 100PF | K ± 10% | 8 | 9.5 ± 0.8 | 8 |
| | 150PF | | 8 | 9.5 ± 0.8 | 8 |
| | 220PF | | 8 | 9.5 ± 0.8 | 8 |
| | 330PF | | 9 | 9.5 ± 0.8 | 8 |
| | 470PF | | 10 | 9.5 ± 0.8 | 8 |
| | 560PF | | 10 | 9.5 ± 0.8 | 8 |
| | 680PF | | 12 | 9.5 ± 0.8 | 8 |
| | 1000PF | | 14 | 9.5 ± 0.8 | 8 |
| +20 ~ -55% (Y5U) | 1000PF | M ± 20% | 8 | 9.5 ± 0.8 | 8 |
| | 1500PF | | 9 | 9.5 ± 0.8 | 8 |
| | 2200PF | | 12 | 9.5 ± 0.8 | 8 |
| | 3300PF | | 14 | 9.5 ± 0.8 | 8 |
| | 3900PF | | 14 | 9.5 ± 0.8 | 8 |
| | 4700PF | | 16 | 9.5 ± 0.8 | 8 |

SCY2 Series

- Special size or items on request
- Tolerance Dimension ± 0.5 mm.

| T.C. | CAP. | TOL. | D | Dimension (mm) | T |
|----------------|--------|---------|----|----------------|---|
| ± 10% (Y5P) | 100PF | K ± 10% | 8 | 7.5 ± 0.8 | 5 |
| | 150PF | | 8 | 7.5 ± 0.8 | 5 |
| | 220PF | | 8 | 7.5 ± 0.8 | 5 |
| | 330PF | | 8 | 7.5 ± 0.8 | 5 |
| | 470PF | | 8 | 7.5 ± 0.8 | 5 |
| | 560PF | | 10 | 7.5 ± 0.8 | 5 |
| | 680PF | | 10 | 7.5 ± 0.8 | 5 |
| | 1000PF | | 12 | 7.5 ± 0.8 | 5 |

| | | | | | |
|---------------------|---------|--------|----|---------|---|
| +30 ~ -80% (Y5V) | 1000PF | M± 20% | 8 | 7.5±0.8 | 5 |
| | 1500PF | | 8 | 7.5±0.8 | 5 |
| | 2200PF | | 9 | 7.5±0.8 | 5 |
| | 3300PF | | 10 | 7.5±0.8 | 5 |
| | 3900PF | | 12 | 7.5±0.8 | 5 |
| | 4700PF | | 12 | 7.5±0.8 | 5 |
| | 6800PF | | 16 | 9.5±0.8 | 5 |
| | 8200PF | | 16 | 9.5±0.8 | 5 |
| | 10000PF | | 18 | 9.5±0.8 | 5 |

PART NUMBERING EXPLANATION

