



2SC4617

NPN SILICON TRANSISTOR

GENERAL PURPOSE TRANSISTOR

FEATURES

- * Low Cob
Cob=2.0pF (typ)
- * Complements the UTC 2SA1774

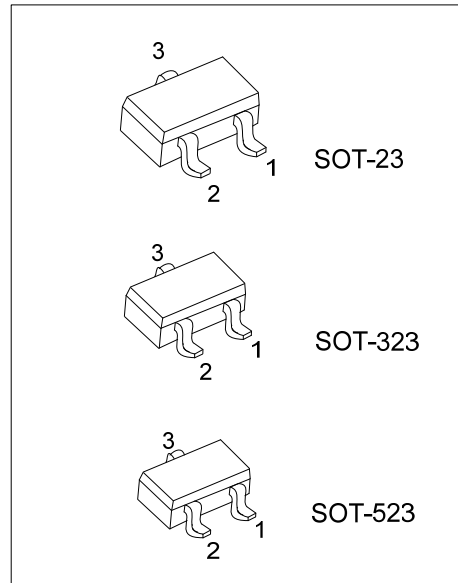

ORDERING INFORMATION

Ordering Number		Package	Pin Assignment			Packing
Lead Free	Halogen Free		1	2	3	
2SC4617L-x-AE3-R	2SC4617G-x-AE3-R	SOT-23	E	B	C	Tape Reel
2SC4617L-x-AL3-R	2SC4617G-x-AL3-R	SOT-323	E	B	C	Tape Reel
2SC4617L-x-AN3-R	2SC4617G-x-AN3-R	SOT-523	E	B	C	Tape Reel

<p>2SC4617L-x-AE3-R</p> <p>(1)Packing Type (2)Package Type (3)Rank (4)Lead Free</p>	<p>(1) R: Tape Reel (2) AE3: SOT-23, AL3: SOT-323, AN3: SOT-523 (3) Refer to CLASSIFICATION OF H_{FE} (4) L: Lead Free, G: Halogen Free</p>
---	---

MARKING

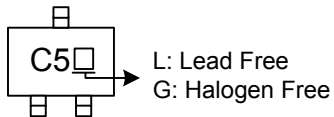

■ ABSOLUTE MAXIMUM RATINGS (Ta = 25°C)

PARAMETER		SYMBOL	RATINGS	UNIT
Collector-Base Voltage		V_{CBO}	60	V
Collector-Emitter Voltage		V_{CEO}	50	V
Emitter-Base Voltage		V_{EBO}	7	V
Collector Current		I_C	0.15	A
Collector Power Dissipation	SOT-523	P_C	150	mW
	SOT-23/SOT-323	P_C	200	mW
Junction Temperature		T_J	+150	°C
Storage Temperature		T_{STG}	-55 ~ +150	°C

Note: Absolute maximum ratings are those values beyond which the device could be permanently damaged. Absolute maximum ratings are stress ratings only and functional device operation is not implied.

■ ELECTRICAL CHARACTERISTICS (Ta= 25°C, unless otherwise specified)

PARAMETER	SYMBOL	TEST CONDITIONS	MIN	TYP	MAX	UNIT
Collector Base Breakdown Voltage	BV_{CBO}	$I_C= 50\mu A$	60			V
Collector Emitter Breakdown Voltage	BV_{CEO}	$I_C= 1mA$	50			V
Emitter-base Breakdown Voltage	BV_{EBO}	$I_E=50\mu A$	7			V
Collector Cut-Off Current	I_{CBO}	$V_{CB}=60V$			0.1	μA
Emitter Cut-Off Current	I_{EBO}	$V_{EB}= 7V$			0.1	μA
DC Current Gain	h_{FE}	$V_{CE}=6V, I_C=1mA$	120		560	
Collector-Emitter Saturation Voltage	$V_{CE(SAT)}$	$I_C=50mA, I_B=5mA$			0.4	V
Transition Frequency	f_T	$V_{CE}=12V, I_E= -2mA, f=100MHz$		180		MHz
Output Capacitance	C_{ob}	$V_{CE}= 12V, I_E= 0A, f=1MHz$		2	3.5	pF

■ CLASSIFICATION OF h_{FE}

RANK	Q	R	S
RANGE	120 ~ 270	180 ~ 390	270 ~ 560

TYPICAL CHARACTERISTICS

Grounded Emitter Propagation Characteristics

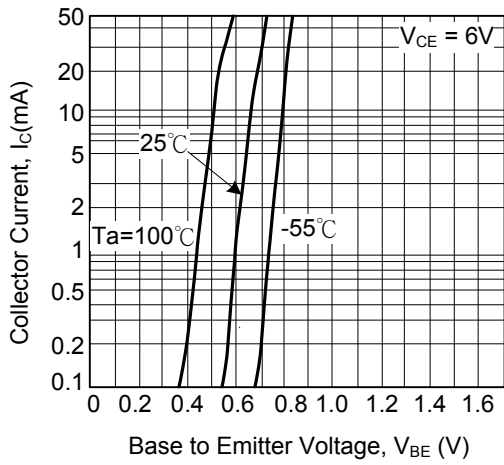

Grounded Emitter Output Characteristics (I)

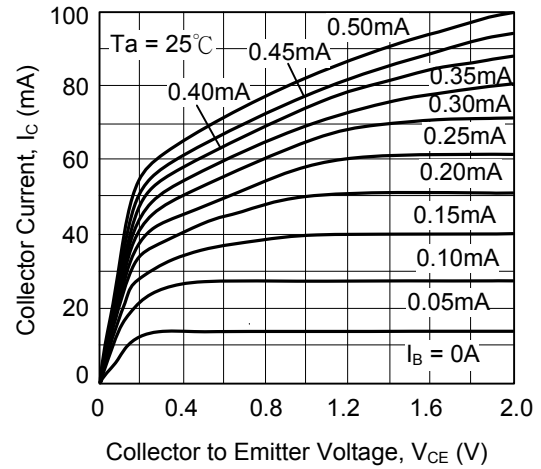

Grounded Emitter Output Characteristics (II)

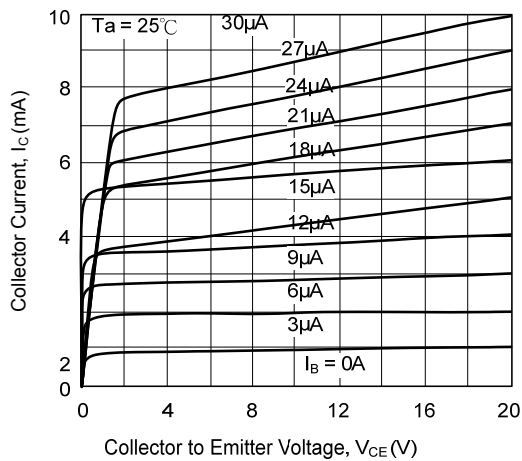

DC Current Gain vs. Collector Current (I)

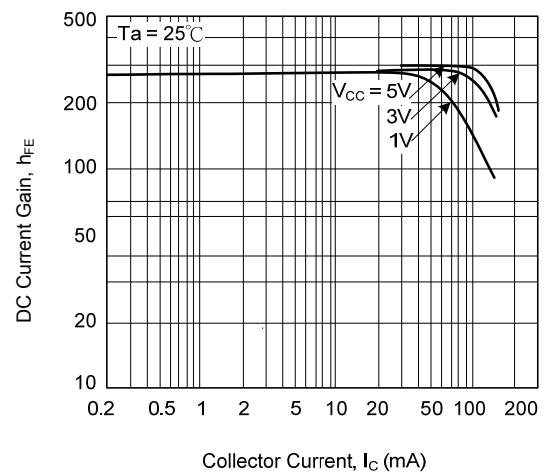

DC Current Gain vs. Collector Current (II)

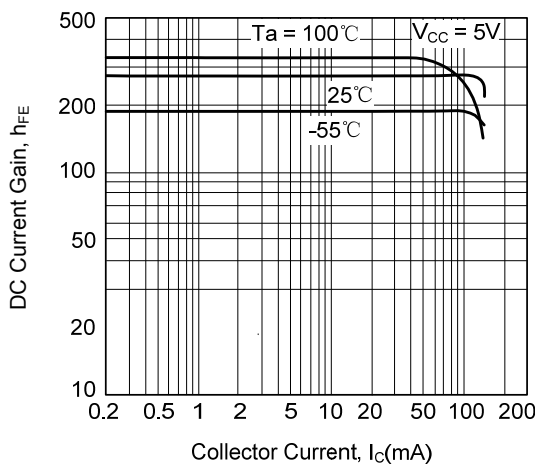

Collector-Emitter Saturation Voltage vs. Collector Current

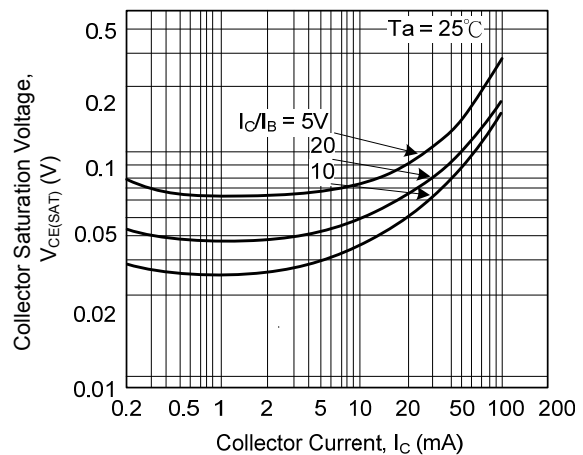

TYPICAL CHARACTERISTICS

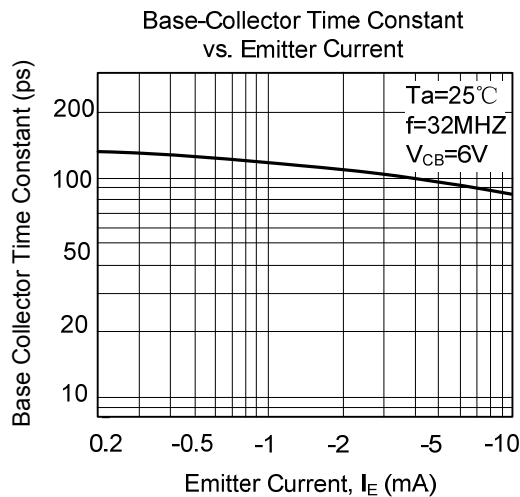
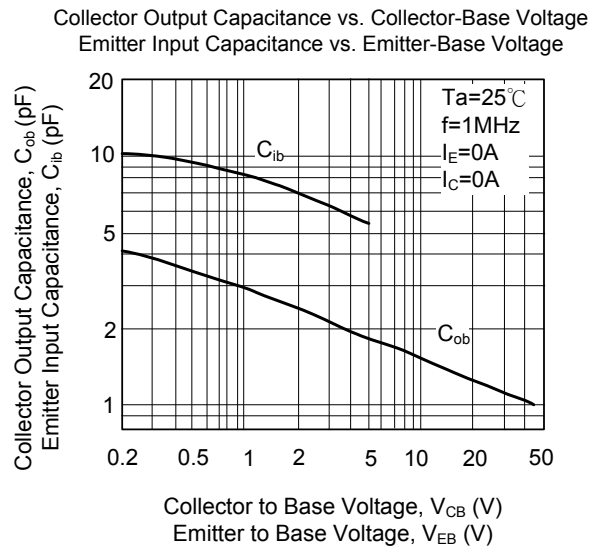
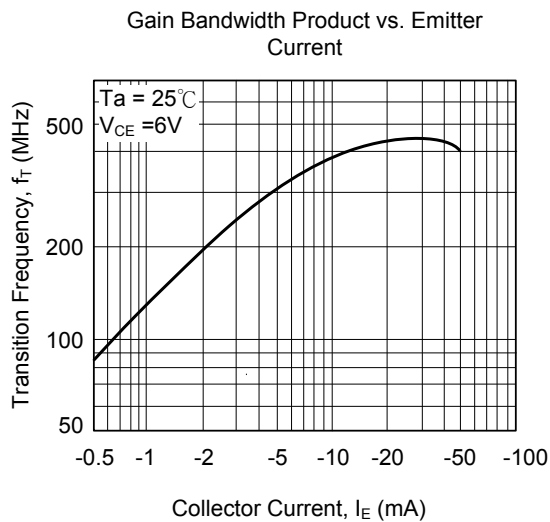
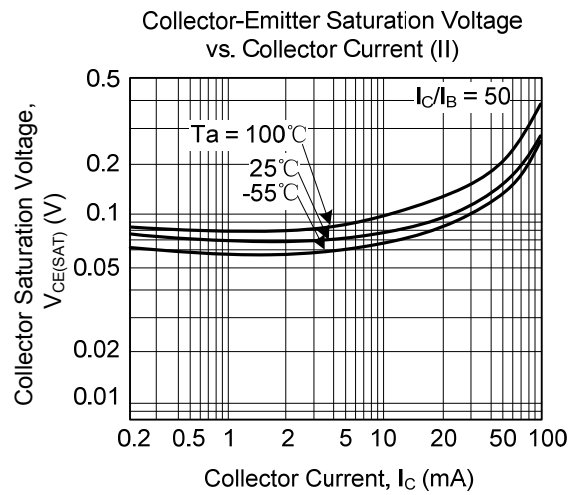
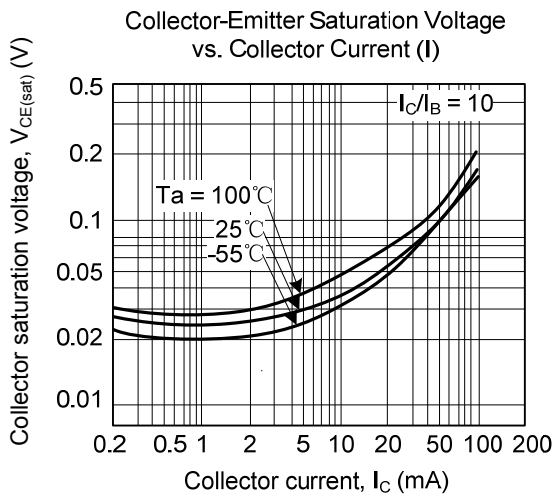

UTC assumes no responsibility for equipment failures that result from using products at values that exceed, even momentarily, rated values (such as maximum ratings, operating condition ranges, or other parameters) listed in products specifications of any and all UTC products described or contained herein. UTC products are not designed for use in life support appliances, devices or systems where malfunction of these products can be reasonably expected to result in personal injury. Reproduction in whole or in part is prohibited without the prior written consent of the copyright owner. The information presented in this document does not form part of any quotation or contract, is believed to be accurate and reliable and may be changed without notice.