



Audio Silicon Specialists

SSM-2014

OPERATIONAL VOLTAGE CONTROLLED ELEMENT

SSM Audio Products

DESCRIPTION

The SSM 2014 is a generalized VCA building block which will substitute for any VCA circuit presently available, in addition to possessing powerful features not available using any other device. It may be configured as a voltage-in or current-in VCA or VCP (voltage controlled potentiometer). In most applications it will replace a standard VCA and two or more op amps. The SSM 2014 offers performance which rivals the best integrated VCA's and closely approaches the performance of modular devices. Configured as a standard VCA circuit, it provides true gain to over 50dB with excellent specifications at any signal level or gain. It provides the function of a voltage controlled preamplifier for both high impedance and balanced low impedance inputs simultaneously. Class A or class AB operation may be selected at the user's option.

FEATURES (used as a standard VCA)

- 116dB Dynamic Range (Class AB)
- 12MHz Effective Gain Bandwidth Product
- Low Cost
- 100dB Open Loop Gain

- Minimum External Component Count
- No trimming Required in Many Applications
- 0.01% Class A THD (Any Gain or Signal, +10dBV in/out)
- Class A or AB Operation

UNIQUE FEATURES

- Replaces any VCA in Any Application
- Combines All Features of Op Amps and VCA's
- Acts As A Voltage Controlled Potentiometer
- Complementary Outputs

- Acts As A Voltage Controlled Preamp
- Has high and Low (Balanced) Impedance Inputs
- Fully Buffered Control Port
- Voltage Selectable Class A or AB Operation

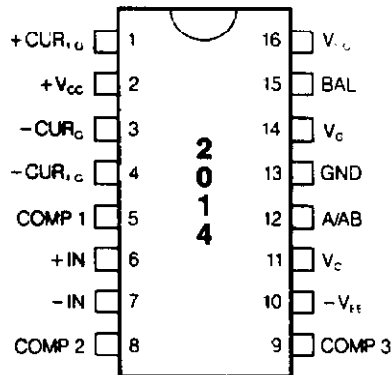

PIN OUT (TOP VIEW)

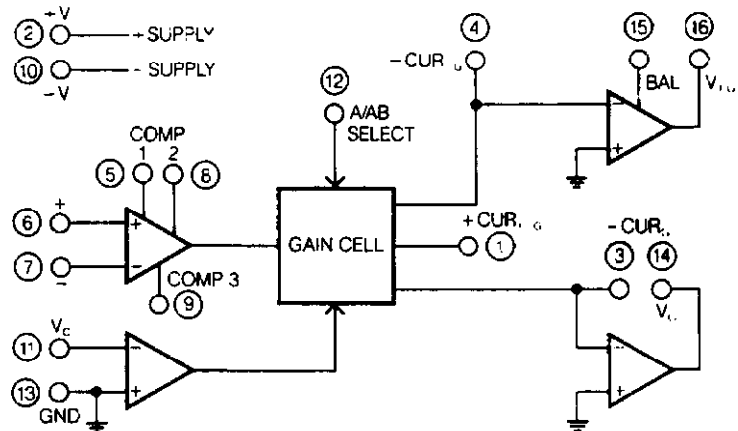

BLOCK DIAGRAM

Revised August 1987

Protected under U. S. Patents #4,471,320 and #4,560,947. Other Patent pending.

The SSM 2014 has been granted mask work protection under the Semiconductor Chip Protection Act of 1983.

SPECIFICATIONS

Operating Temperature: -10°C to $+55^{\circ}\text{C}$; Storage Temperature: -55°C to $+125^{\circ}\text{C}$
 The following specifications apply for $V_{\text{sup}} = \pm 15\text{V}$, $T_a = 25^{\circ}\text{C}$.

PARAMETER	MIN	TYP	MAX	UNITS	CONDITIONS
Input Amplifier:					
Bias Current		100	300	nA	
Input Offset Current		15	30	nA	
Input Offset Voltage		2	5	mV	
Input Impedance	.5	1		$\text{M}\Omega$	
Equivalent Input Noise		18		$\text{nV}/\sqrt{\text{Hz}}$	@ 1kHz
Common Mode Range		+13, -13		V	
Open Loop Gain	75	100		V/mV	
Effective Gain BW Product		12		MHz	VCA Configuration
		.5		MHz	VCP Configuration
Slew Rate		6V/ μS			VCA Configuration
Supply Current - Positive		7.5	9	mA	
Supply Current - Negative		10	12	mA	
Output Amplifiers:					
Offset Voltage		10	20	mV	
Minimum Load		9	10	$\text{k}\Omega$	For Full Output Swing
Output Voltage Swing		± 13.5		V	
Noise Residual		8	10	μV	20KHz Bandwidth
Control Port:					
Bias Current		150	300	nA	
Input Impedance		1		$\text{M}\Omega$	
Gain Constant		-30		mV/dB	Ratio of outputs
Gain Constant Temp. Coefficient		-3300		ppm/C	
Gain Linearity		0.5		%	
Control Feedthrough (trimmed)					100Hz Sine Wave Applied to Control Port Causing -30dB to +20dB of Gain
Class A		2		mV	
Class AB		0.5		mV	
Intermediate		1		mV	
Control Feedthrough (untrimmed)					100Hz Sine Wave Applied to Control Port Causing -30dB to +20dB of Gain
Class A		25	75	mV	
Class AB ¹		5	15	mV	
Intermediate ¹		15	45	mV	
Off Isolation	100	105		dB	@ 1kHz
Channel Specifications:					
Noise ² - Class A		-84	-81	dBV	Rpin12 = 33K 20kHz B.W.
Noise ² - Class AB		-95	-92	dBV	Rpin12 = 330K 20kHz B.W.
Noise ² - Intermediate		-88	-85	dBV	Rpin12 = 43K 20kHz B.W.
THD ³ - A @ $A_v = 0\text{dB}$		0.005	0.02	%	Rpin12 = 33K
THD ³ - A @ $A_v = 20\text{dB}$		0.02	0.04	%	Rpin12 = 33K
THD ³ - AB @ $A_v = 0\text{dB}$		0.02	0.05	%	Rpin12 = 330K
THD ³ - AB @ $A_v = 20\text{dB}$		0.06	0.12	%	Rpin12 = 330K
THD ³ - Interm @ $A_v = 0\text{dB}$		0.01	0.03	%	Rpin12 = 43K
THD ³ - Interm @ $A_v = 20\text{dB}$		0.03	0.06	%	Rpin12 = 43K

¹Symmetry trim only. ²Parameter sample lot tested to maximum limits. ³ V_{in} and/or $V_{\text{out}} = +10\text{dBV}$.
 Specifications may be subject to change without notice.



General

The 2014 is a new type of general purpose signal processing device which we have named an Operational Voltage Controlled Element. The inputs can be configured to operate either differentially or single ended in terms of voltage or current. The output(s) can also operate either in the current or voltage domain. This unique input/output structure enables the 2014 to act not only in standard voltage controlled amplifier (VCA) applications, but also as a cost effective solution to many other functions calling for voltage control of high performance audio signal paths.

Input Stage (Pins 5-9, 12)

The input stage of the 2014 consists of an op amp with differential inputs and a gain variable compensation scheme under control of the gain control port. This variable compensation makes it possible to maintain a bandwidth in excess of 120kHz over the gain range of +40dB. The output of the op amp faces a current splitter with a variable bias point under control of pin 12. This bias point establishes the quiescent current in the gain core and thus affects the noise, distortion, and control feedthrough performance.

A current between 40 to 500uA must be sourced into pin 12 for proper operation of the device. Without such a current, the output signal will appear half-wave rectified. A resistor connected between pin 12 and the positive supply can be used to establish this current. The table below indicates the recommended resistor values and typical performance trade-offs for the various classes of operation:

CLASS	A	AB	INT.	CONDITION
Rset	33K	330K	43K	Vs = ±15V
Noise	-84dBV	-95dBV	-88dBV	20kHz Bandwidth
THD @ Av=0dB	0.005	0.02	0.010*	+10dBV in/out @ 1kHz
THD @ Av=+20dB	0.02	0.06	0.030*	+10dBV in/out @ 1kHz
THD Type	Pure2nd	Mostly3rd	2nd*	
Trimmed Control				
Feedthrough	2mV	500uV	1mV	-30dB gain +20dB

*for intermediate operation near unity gain, distortion will increase and become mostly third harmonic for levels above +14dBV in/out.

Class A operation is preferred for its distortion performance, particularly at high signal levels and over gain or attenuation. Also, class A distortion is nearly pure second harmonic which is, in sonic terms, less objectionable than other types.

Noise and control feedthrough performance are significantly better in class AB. These specifications are important at low signal levels.

It is possible to realize the virtues of both classes of operation by using a level detector sensing the input signal level to change the VCA from class AB at lower signal levels (<+4dBV) to class A above this. A time constant in the range between 10 and 25 milliseconds should be included in the level detector not only to smooth the signal, but to subjectively eliminate the resulting noise floor modulation and output offset shift. Both of these effects are small compared to the signal level at which the class of operation changes.

Intermediate class operation may be preferred as a good compromise in many VCA applications. The distortion performance is nearly that of class A and the noise and control feedthrough specifications are about halfway between A and AB.

Control Port (Pin 11)

The control sensitivity of the control port is -30dB/volt (at pin 11). Like all dB/volt VCA's, this sensitivity has a -3300 ppm/°C temperature coefficient. This drift can be compensated for in automation systems by using a single tempistor* with a +3300 ppm/°C drift for the reference current set resistor in the system DAC. An attenuator is usually connected in series between the control voltage source and the control port to appropriately scale the available control voltage range. The worst case input bias current is 300nA so the impedance of the attenuator from the pin to ground must be kept small enough that the resulting voltage drop does not cause a significant gain error (10K or less is recommended). Noise and distortion of the 2014 are unaffected by the impedance at the control port; however, care must be taken to eliminate coupling to signal paths, especially if higher impedances are used.

Outputs (Pins 1, 3, 4, 14, and 16)

The 2014 can output signal either in terms of current (pins 1, 3 and 4) or voltage (pins 14 and 16). The worst case (lowest) maximum signal the current outputs can provide is ±675uA when operated from ±15 volt supplies. This determines the lowest value for the feedback resistors that can be used for the internal or external current to voltage convertor op amps (~20K). If external op amps are used

*RCD Components, Inc. part number LP1/4, 3301 Bedford Street, Manchester, NH U.S.A., (603) 669-0054, Telex 943512

Source for Tempistors

Trimming

In each circuit, two trimpots are shown. Both affect offset and control feedthrough. The waveform symmetry trim also affects distortion. This trim is mandatory for acceptable class AB distortion but may not be required for non-critical class A-only operation. The other trim is needed whenever the worst case untrimmed control feedthrough specification (A or AB) is not deemed adequate.

The symmetry trim, if used, is always performed first. Distortion is nulled at unity gain with a 1kHz sinewave input between +4 and +10 dBV.

Next, with the signal input grounded, a 100Hz sinewave is applied to the control port with its peaks corresponding to the maximum gain required and 30dB of attenuation. The control feedthrough is then nulled using the offset trimmer. As an option, the control feedthrough can be further reduced in class A by a slight readjustment of the symmetry trim.

The class A and class AB control feedthrough null points do not exactly coincide. If both classes of operation are used, such as the level detector controlled switching scheme discussed earlier, the class AB null point should be chosen. A D.C. blocking capacitor is required in series with the signal input to prevent offsets in previous stages affecting the control feedthrough performance.

For many applications, such as the panning and EQ circuits described below, control feedthrough trimming should not be required. This is because the control settings on these circuits are varied infrequently, usually during setup, and the effects of control feedthrough can be suppressed by inserting a 10 to 20mS time constant in the control path.

Self-Contained VCA

Figure 4 shows a self-contained VCA with a provision for differential inputs. This circuit is a slight variation of the circuit of Figure 3B using Figure 1 as the O.V.C.E. Notice that current feedback from pin 1 (+CUR_{I-G}) to pin 7 and from pin 4 (-CUR_{I-G}) to pin 6 is used to create differential virtual grounds. The clamp diodes prevent fast sub-uSec transients from overdriving the input stage in class AB. Signal inputs may be applied through 22K ohm resistors and blocking capacitors to either pin-6 or pin-7 on the I.C. This will produce inverting or non-inverting operation in the single-ended case if only one is used. It should be noted that if large common mode signals are present in differential operation, then class A operation should be chosen. Figure 5 shows typical distortion measurements using this circuit over gain and attenuation. The tests were made with a single-ended 1kHz source driving the input and/or output to a signal level of +10dBV regardless of gain or attenuation. This is 10dB below clipping. Three cases are shown; namely full class A, class AB, and intermediate bias between those two extremes. Figure 6 shows the noise performance of the device with shorted input operating in the three bias cases. Noise was measured in a 20kHz bandwidth.

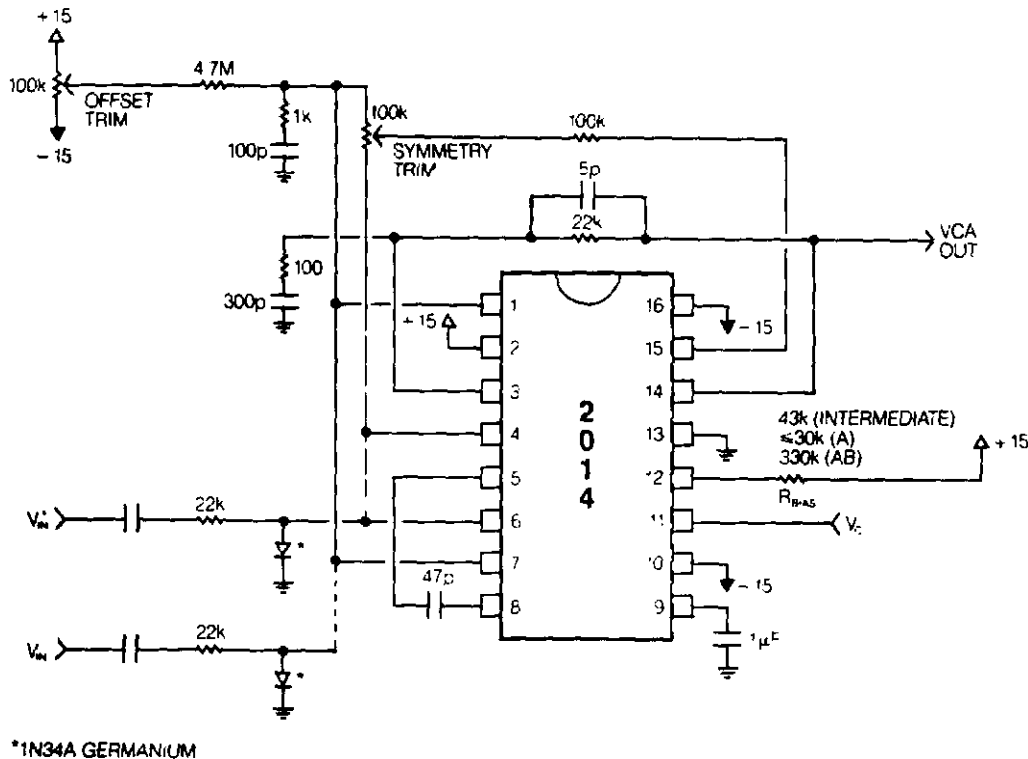

FIGURE 4. MINIMUM VCA (DIFFERENTIAL INPUTS)

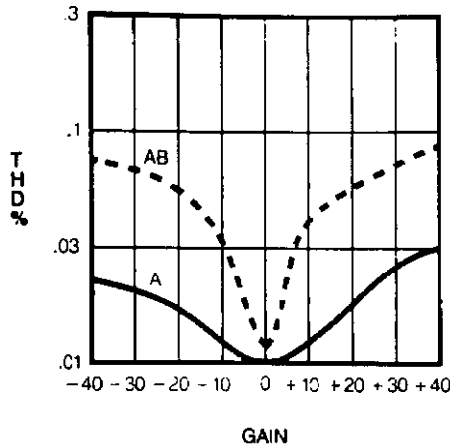

FIGURE 5. VCA THD PERFORMANCE CURVES

Typical distortion measurements for the circuit of Figure 4
+ 10dBV in/out signal level.

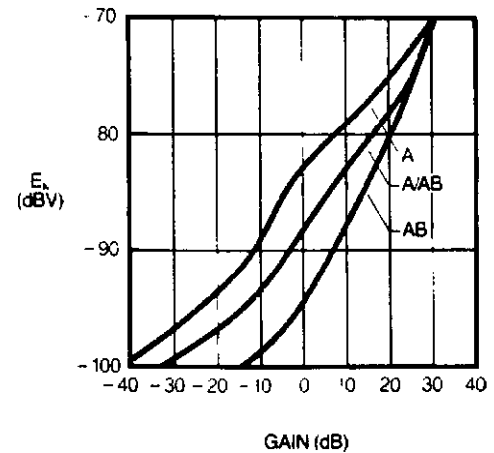

FIGURE 6. VCA NOISE VS GAIN (20KHz) BANDWIDTH)

Full VCA Pre-Amp

Figure 7 shows the SSM 2014 configured as a full VCA preamp accepting both high impedance unbalanced and low impedance balanced inputs simultaneously. A fixed gain output providing 20dB of gain on the unbalanced input is available in addition to a voltage-controlled output. All the measurement data shown was taken using an intermediate bias between class A and AB as shown in the previous section. Performance in full class A or class AB operation varies from the intermediate bias in substantially the same way as for the VCA. Figures 8 and 9 show distortion and noise with an input applied to the high impedance input. In the case of distortion measurements, a 1kHz sine-wave is applied in such a way as to drive one or both outputs to +10dBV.

The auxiliary specifications are quite good for the device operating in this configuration. The effective gain bandwidth product was measured to be 12MHz with an accompanying slew rate of about 10V per microsecond. The control feedthrough was measured at 3mv peak to peak, with a 100Hz sine wave varying gain from +40dB to 0dB. Tests were conducted with a balanced 600 ohm input using more than 70dB of gain which showed essentially the same noise and distortion performance as before where the nominal gain for this source was 34dB corresponding to 20dB from the high impedance input.

Panning Circuit

Figure 10 shows the SSM 2014 configured as a panning circuit or voltage controlled potentiometer (VCP). The gain characteristics relating the input signal to the two outputs are exactly complementary with both outputs summing to a fixed constant times the input. Since the noise and distortion performance is completely complementary, Figures 11 and 12 show only the distortion and noise at the V output using class AB bias. The excellent distortion performance did not warrant class A bias. The same test conditions were imposed as above. The variable compensation circuitry is not applicable in this kind of configuration but the gain bandwidth product is not of concern since the maximum gain is near unity. The slew rate is 6V per microsecond for the inverting circuit and somewhat less for the non-inverting connection. Control feedthrough for the voltage controlled potentiometer circuit is 500uV peak to peak with a 100Hz sine wave varying the gain from full on to -40dB. This panning circuit may be configured for inverting or non-inverting operation in the same way that any operational amplifier circuit may be used. The noise and distortion of this configuration are truly exceptional.

It is common in high quality panning circuitry to have the center gain representing a balance between left and right to be not equal to -6dB. It is possible with external circuitry to modify the SSM 2014 panning circuit described earlier in such a way as to produce a center gain of nominally less than 6dB of attenuation while still maintaining the complementary nature of the two outputs. This is possible due to the unusual nature of the circuitry involving the internal frequency compensation of the IC. By using the COMP 3 pin on the SSM 2014 and additional circuitry one can vary the sum gain of the two outputs without changing their complementary nature in such a way as to produce the desired panning effect. Contact SSMT for further information.

Variable Reciprocal Equalizer - High Pass Type

Figure 13 shows the SSM 2014 configured as a variable reciprocal equalizer circuit of the high pass type, which represents the worst case for noise and distortion. Once again class AB bias was chosen for the specific measurements on noise and distortion due to the

excellent characteristics of this circuit. This data is shown in Figure 14. Figure 15 shows the equalization gain characteristics as a function of frequency and control voltage. Control feedthrough characteristics are better than those for the panning circuit; typically 500 uV peak to peak. Substitution of the high pass filter for a low pass filter or band pass filter will automatically reprogram this equalizer as a low pass or band pass type with equal or better noise and distortion characteristics. Therefore the SSM 2014 may be used to implement any type of reciprocal equalizer in a straightforward way. The performance of this circuit is comparable to equalizers with no voltage control, making it a very attractive alternative.

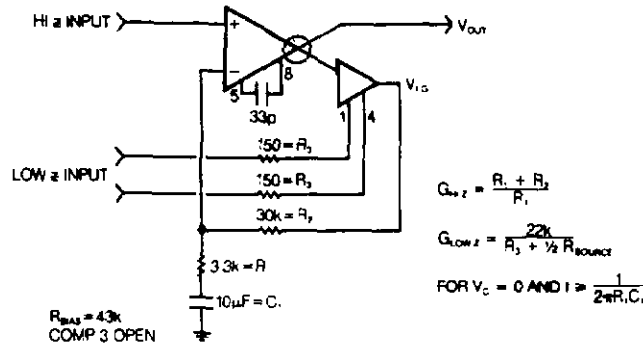

FIGURE 7. PREAMP CIRCUIT

SSM 2014 configured as a voltage controlled preamp with high and balanced low impedance inputs.

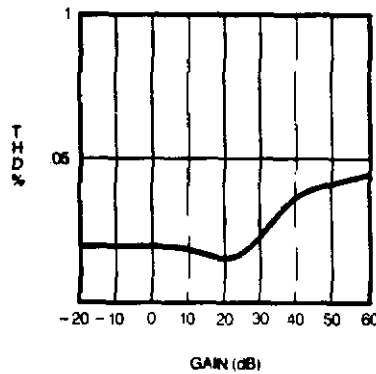

FIGURE 8. PREAMP THD PERFORMANCE VS GAIN

Typical distortion measurements for the circuit of Figure 7 + 10dBV $V_{out}/V_{1,0}$ signal level.

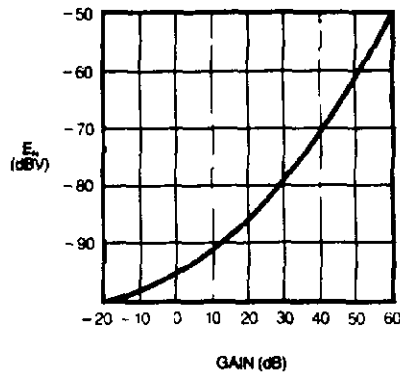

FIGURE 9. PREAMP NOISE PERFORMANCE VS GAIN (20KHz BANDWIDTH)

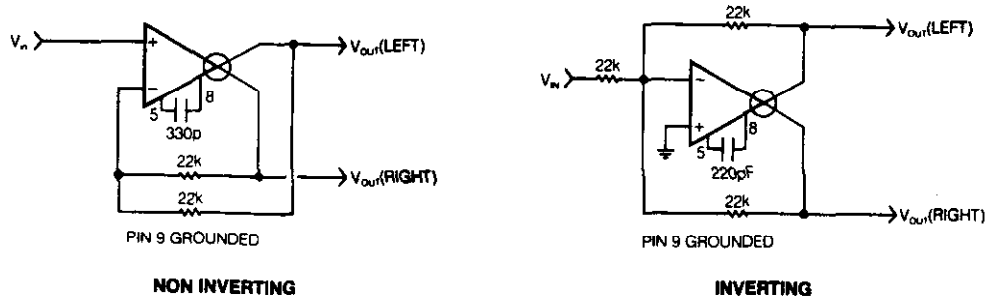

FIGURE 10. VOLTAGE CONTROLLED PANNING CIRCUITS

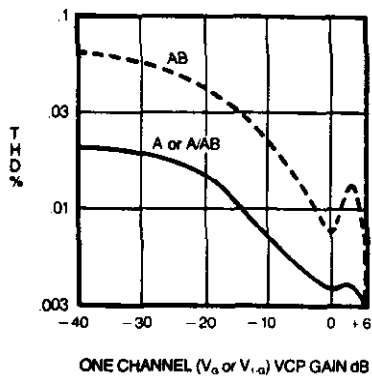

FIGURE 11. VCP TYPICAL THD PERFORMANCE CURVES (1KHz ± 10dB $V_o/V_{i,a}$) NON INVERTING

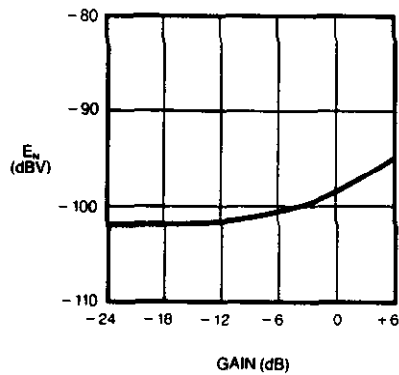

FIGURE 12. NOISE PERFORMANCE OF CIRCUIT OF FIGURE 10 (20KHz BANDWIDTH) NON INVERTING

EQ CONFIGURATION

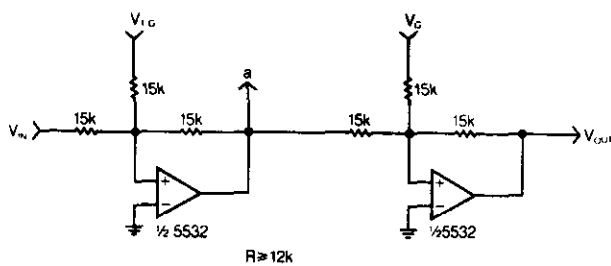

FIGURE 13A.

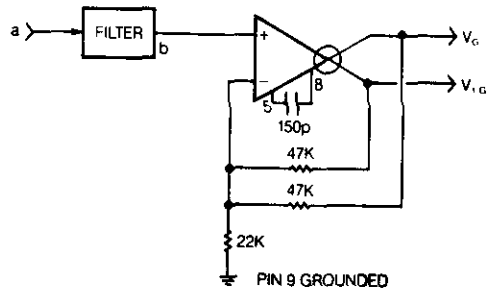

FIGURE 13B.

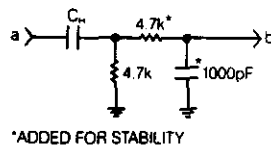

FIGURE 13C. HIGH PASS FILTER

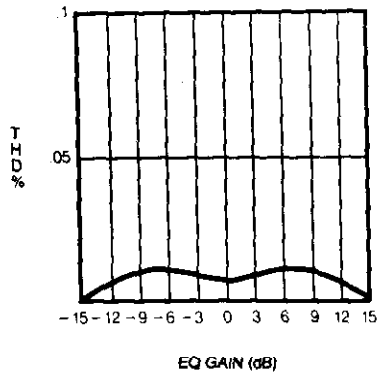

FIGURE 14(A). EQ THD PERFORMANCE VS GAIN

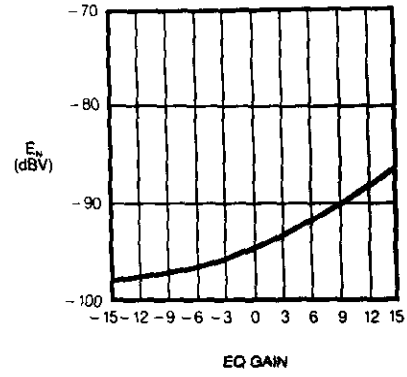
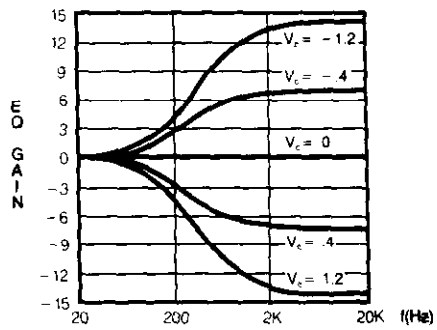

 FIGURE 14(B). EQ NOISE PERFORMANCE VS GAIN
(20KHz BANDWIDTH)

FIGURE 15(A). EQ GAIN VS FREQUENCY PROFILES

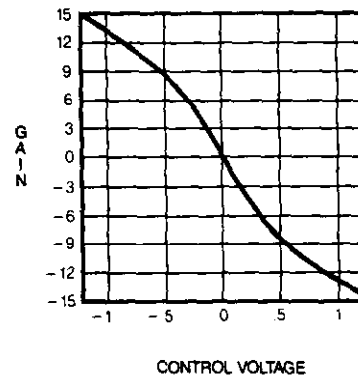

FIGURE 15(B). EQ CONTROL CHARACTERISTIC