

**N-CHANNEL ENHANCEMENT-MODE POWER MOSFET**

Dynamic dv/dt rating  
 Repetitive-avalanche rated  
 Fast switching  
 Simple drive requirement

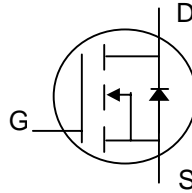

$BV_{DSS}$  600V  
 $R_{DS(ON)}$  8 $\Omega$   
 $I_D$  1.6A

**Description**

The SSM01N60H is supplied in the industry-standard TO-252 package, which is widely preferred for commercial and industrial surface mount applications, and is well suited for AC/DC converters. The through-hole version (SSM01N60J) is available for low-footprint applications.

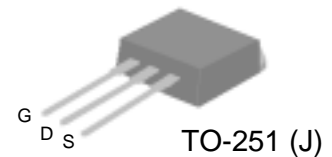
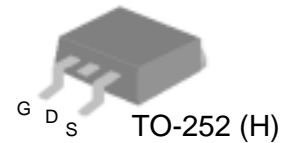
**Absolute Maximum Ratings**

Symbol	Parameter	Rating	Units
$V_{DS}$	Drain-Source Voltage	600	V
$V_{GS}$	Gate-Source Voltage	$\pm 30$	V
$I_D @ T_C=25^\circ\text{C}$	Continuous Drain Current, $V_{GS} @ 10\text{V}$	1.6	A
$I_D @ T_C=100^\circ\text{C}$	Continuous Drain Current, $V_{GS} @ 10\text{V}$	1	A
$I_{DM}$	Pulsed Drain Current <sup>1</sup>	6	A
$P_D @ T_C=25^\circ\text{C}$	Total Power Dissipation	39	W
	Linear Derating Factor	0.31	W/ $^\circ\text{C}$
$E_{AS}$	Single Pulse Avalanche Energy <sup>2</sup>	13	mJ
$I_{AR}$	Avalanche Current	1.6	A
$E_{AR}$	Repetitive Avalanche Energy	0.5	mJ
$T_{STG}$	Storage Temperature Range	-55 to 150	$^\circ\text{C}$
$T_J$	Operating Junction Temperature Range	-55 to 150	$^\circ\text{C}$

**Thermal Data**

Symbol	Parameter	Value	Unit
Rthj-c	Thermal Resistance Junction-case	Max. 3.2	$^\circ\text{C}/\text{W}$
Rthj-a	Thermal Resistance Junction-ambient	Max. 110	$^\circ\text{C}/\text{W}$

**Electrical Characteristics @  $T_j=25^{\circ}\text{C}$  (unless otherwise specified)**

Symbol	Parameter	Test Conditions	Min.	Typ.	Max.	Units
$BV_{DSS}$	Drain-Source Breakdown Voltage	$V_{GS}=0V, I_D=250\mu A$	600	-	-	V
$\Delta BV_{DSS}/\Delta T_j$	Breakdown Voltage Temperature Coefficient	Reference to $25^{\circ}\text{C}$ , $I_D=1\text{mA}$	-	0.6	-	$\text{V}/^{\circ}\text{C}$
$R_{DS(ON)}$	Static Drain-Source On-Resistance	$V_{GS}=10V, I_D=0.8A$	-	7.2	8	$\Omega$
$V_{GS(th)}$	Gate Threshold Voltage	$V_{DS}=V_{GS}, I_D=250\mu A$	2	-	4	V
$g_{fs}$	Forward Transconductance	$V_{DS}=10V, I_D=0.8A$	-	0.8	-	S
$I_{DSS}$	Drain-Source Leakage Current ( $T_j=25^{\circ}\text{C}$ )	$V_{DS}=600V, V_{GS}=0V$	-	-	10	$\mu A$
	Drain-Source Leakage Current ( $T_j=150^{\circ}\text{C}$ )	$V_{DS}=480V, V_{GS}=0V$	-	-	100	$\mu A$
$I_{GSS}$	Gate-Source Leakage	$V_{GS}=\pm 30V$	-	-	$\pm 100$	nA
$Q_g$	Total Gate Charge <sup>3</sup>	$I_D=1.6A$	-	7.7	-	nC
$Q_{gs}$	Gate-Source Charge	$V_{DS}=480V$	-	1.5	-	nC
$Q_{gd}$	Gate-Drain ("Miller") Charge	$V_{GS}=10V$	-	2.6	-	nC
$t_{d(on)}$	Turn-on Delay Time <sup>3</sup>	$V_{DD}=300V$	-	8	-	ns
$t_r$	Rise Time	$I_D=1.6A$	-	5	-	ns
$t_{d(off)}$	Turn-off Delay Time	$R_G=10\Omega, V_{GS}=10V$	-	14	-	ns
$t_f$	Fall Time	$R_D=187.5\Omega$	-	7	-	ns
$C_{iss}$	Input Capacitance	$V_{GS}=0V$	-	286	-	pF
$C_{oss}$	Output Capacitance	$V_{DS}=25V$	-	25	-	pF
$C_{rss}$	Reverse Transfer Capacitance	$f=1.0\text{MHz}$	-	6	-	pF

**Source-Drain Diode**

Symbol	Parameter	Test Conditions	Min.	Typ.	Max.	Units
$I_S$	Continuous Source Current ( Body Diode )	$V_D=V_G=0V, V_S=1.5V$	-	-	1.6	A
$I_{SM}$	Pulsed Source Current ( Body Diode ) <sup>1</sup>		-	-	6	A
$V_{SD}$	Forward On Voltage <sup>3</sup>	$T_j=25^{\circ}\text{C}, I_S=1.6A, V_{GS}=0V$	-	-	1.5	V

**Notes:**

1. Pulse width limited by safe operating area.
2. Starting  $T_j=25^{\circ}\text{C}$ ,  $V_{DD}=50V$ ,  $L=10\text{mH}$ ,  $R_G=25\Omega$ ,  $I_{AS}=1.6A$ .
3. Pulse width  $\leq 300\mu\text{s}$ , duty cycle  $\leq 2\%$ .

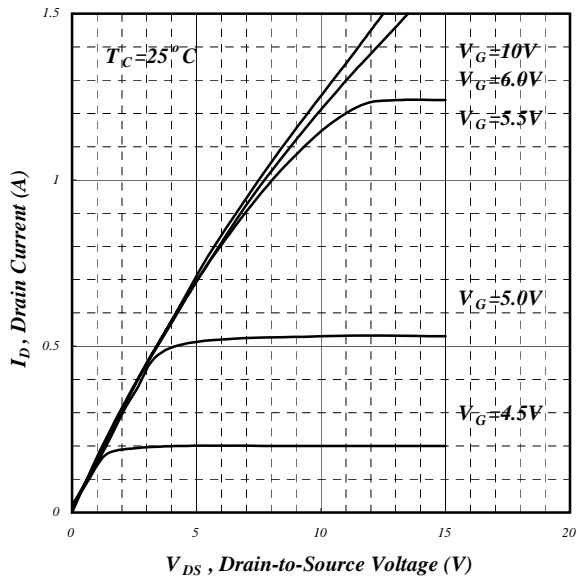

Fig 1. Typical Output Characteristics

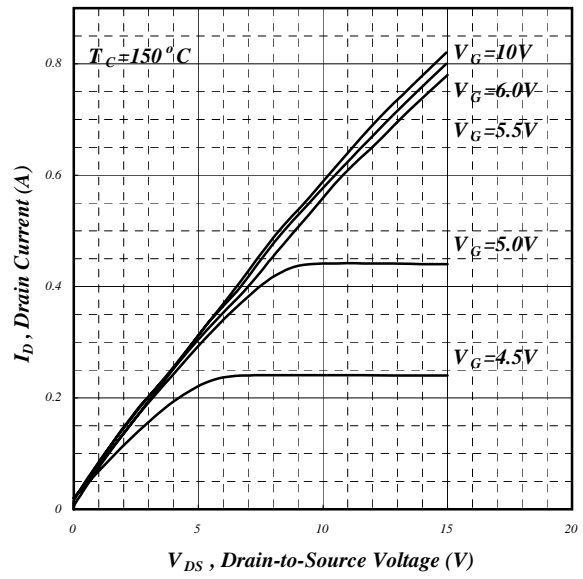

Fig 2. Typical Output Characteristics

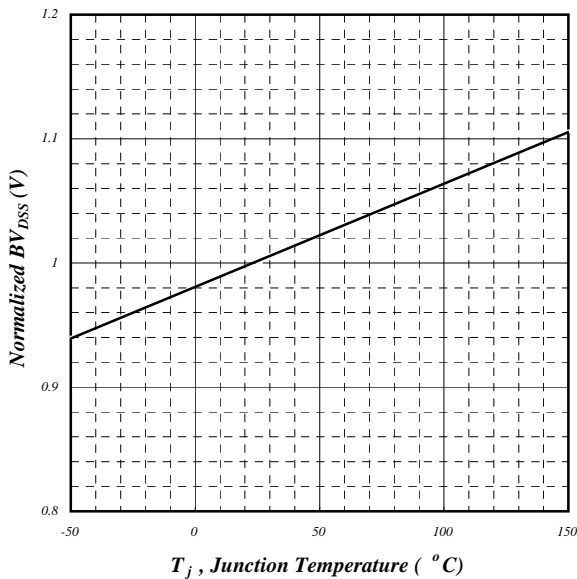

Fig 3. Normalized  $BV_{DSS}$  vs. Junction Temperature

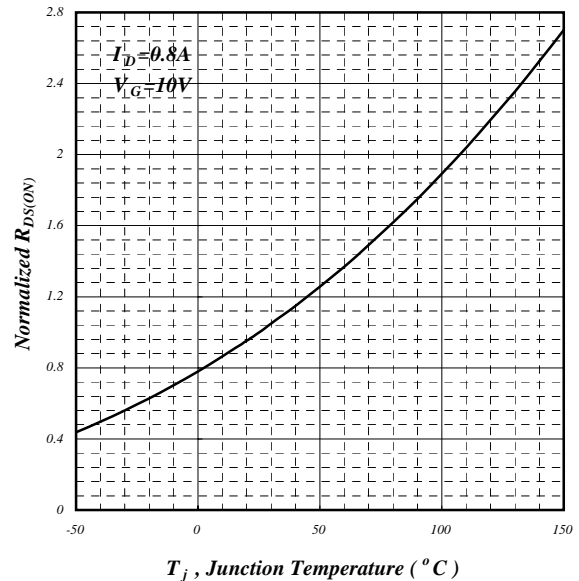

Fig 4. Normalized On-Resistance vs. Junction Temperature

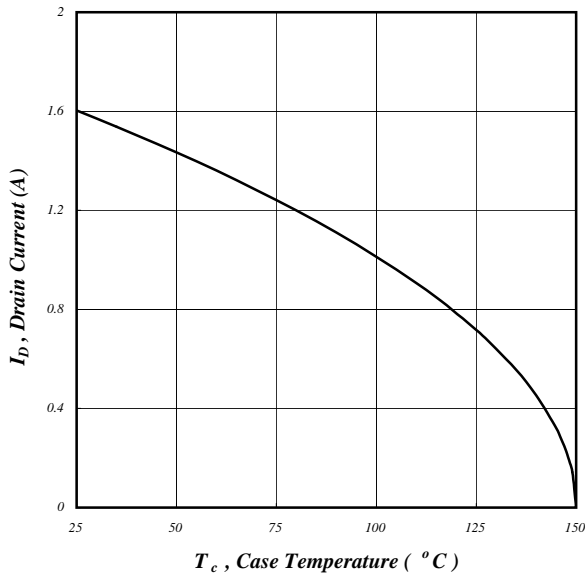

Fig 5. Maximum Drain Current vs. Case Temperature

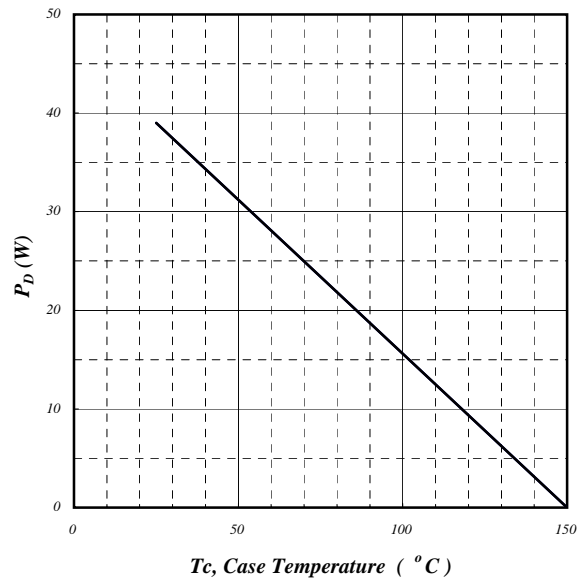

Fig 6. Typical Power Dissipation

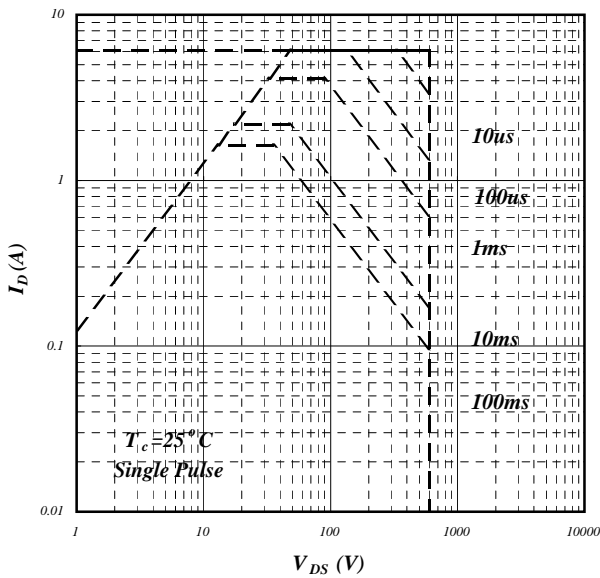

Fig 7. Maximum Safe Operating Area

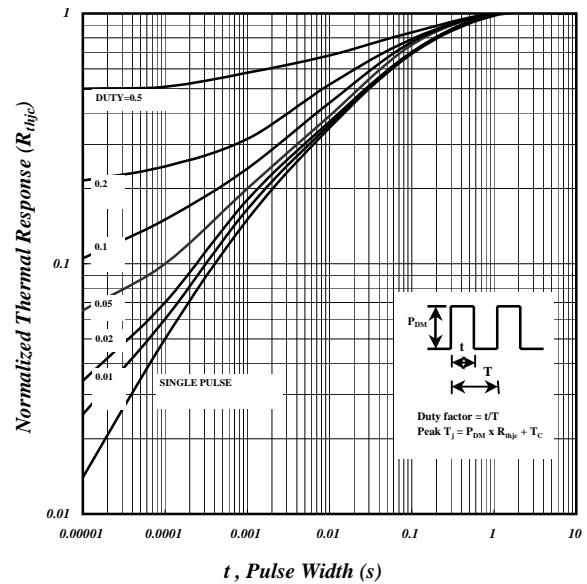

Fig 8. Effective Transient Thermal Impedance

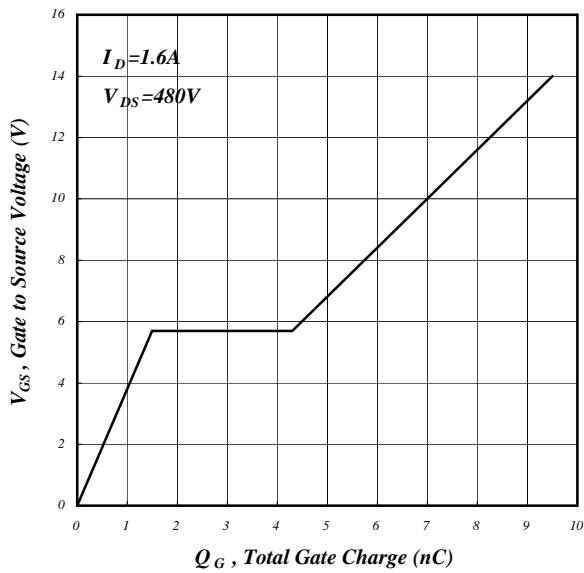

Fig 9. Gate Charge Characteristics

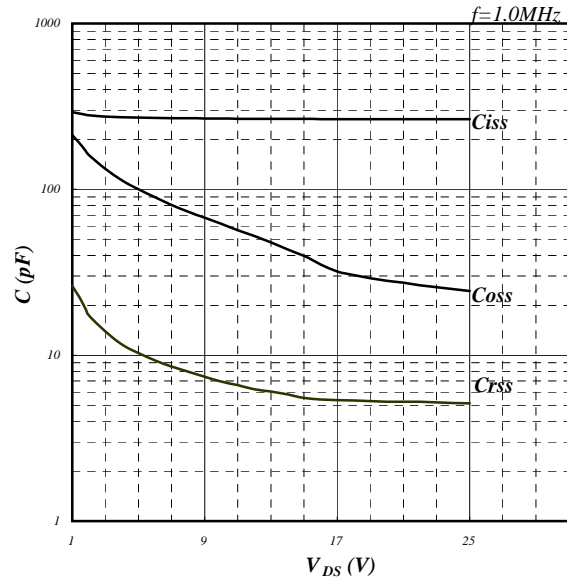

Fig 10. Typical Capacitance Characteristics

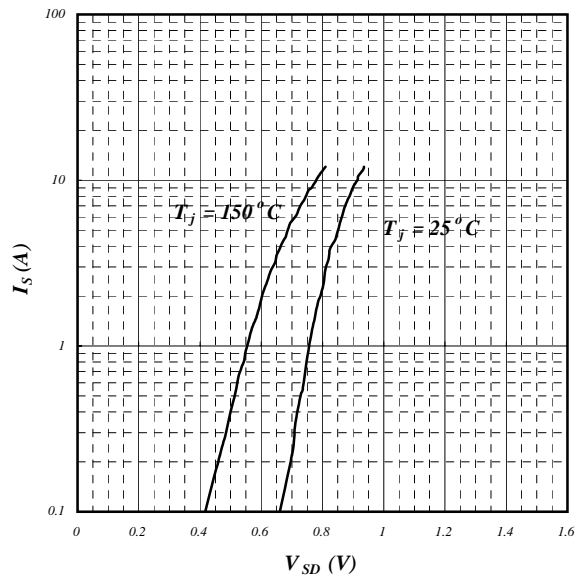

Fig 11. Forward Characteristic of Reverse Diode

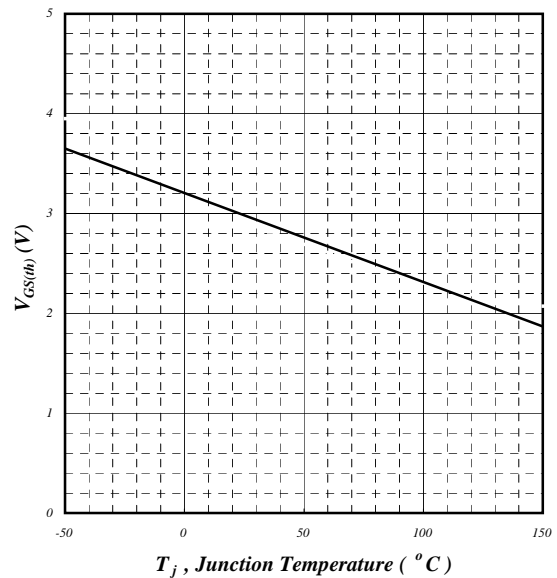

Fig 12. Gate Threshold Voltage vs. Junction Temperature

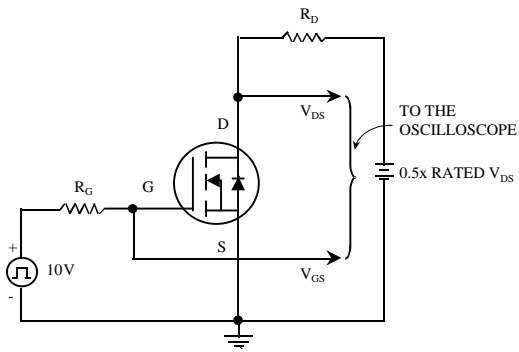

Fig 13. Switching Time Circuit

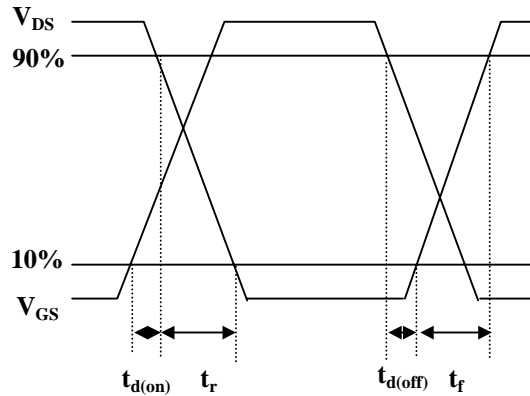

Fig 14. Switching Time Waveform

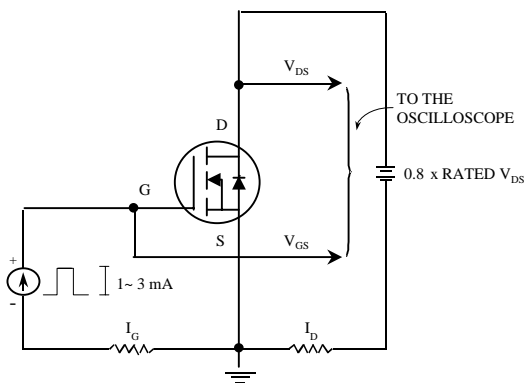

Fig 15. Gate Charge Circuit

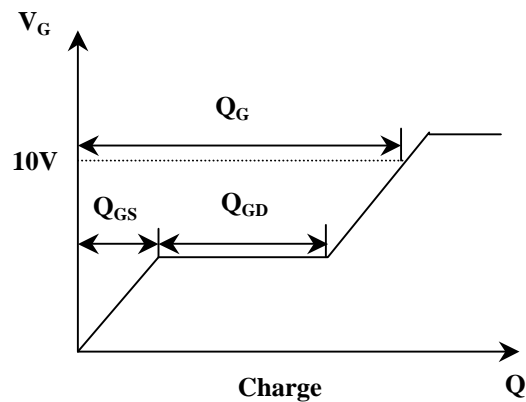

Fig 16. Gate Charge Waveform

Information furnished by Silicon Standard Corporation is believed to be accurate and reliable. However, Silicon Standard Corporation makes no guarantee or warranty, express or implied, as to the reliability, accuracy, timeliness or completeness of such information and assumes no responsibility for its use, or for infringement of any patent or other intellectual property rights of third parties that may result from its use. Silicon Standard reserves the right to make changes as it deems necessary to any products described herein for any reason, including without limitation enhancement in reliability, functionality or design. No license is granted, whether expressly or by implication, in relation to the use of any products described herein or to the use of any information provided herein, under any patent or other intellectual property rights of Silicon Standard Corporation or any third parties.