

### 1. PART NO. EXPRESSION :

SWDY1008-R47MF-NC

(a) (b) (c) (d)(e) (f)

(a) Series code

(b) Dimension code

(c) Inductance code : R47 = 0.47uH

(d) Tolerance code : M = ±20%

(e) F : Lead Free

(f) NC : No Cover

### 2. CONFIGURATION & DIMENSIONS :

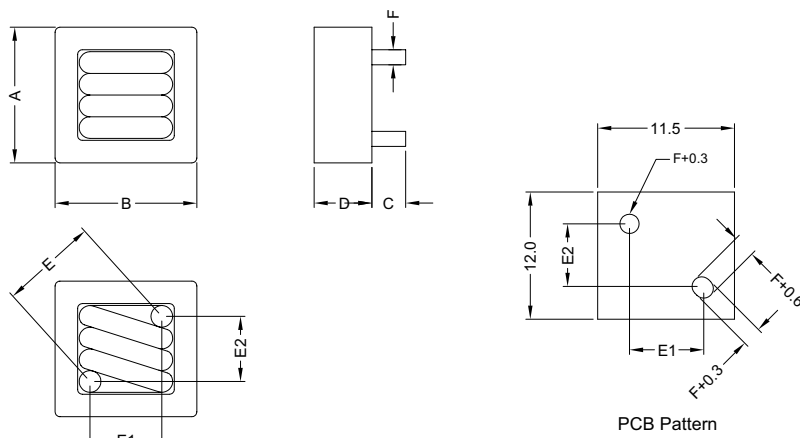

Part No.	A mm	B mm	C mm	D mm	E mm	E1 mm	E2 mm	F mm
SWDY1008-R47MF-NC	11.0 Max.	11.5 Max.	3.5±0.5	8.5 Max.	8.2±0.5	6.0±0.5	5.6±0.5	1.4±0.1
SWDY1008-R60MF-NC	11.0 Max.	11.5 Max.	3.5±0.5	8.5 Max.	8.2±0.5	6.0±0.5	5.6±0.5	1.4±0.1
SWDY1008-R80MF-NC	11.0 Max.	11.5 Max.	3.5±0.5	8.5 Max.	8.6±0.5	6.2±0.5	5.9±0.5	1.3±0.1
SWDY1008-1R0MF-NC	11.0 Max.	11.5 Max.	3.5±0.5	8.5 Max.	8.6±0.5	6.2±0.5	5.9±0.5	1.3±0.1

### 3. SCHEMATIC :



### 4. MATERIALS :

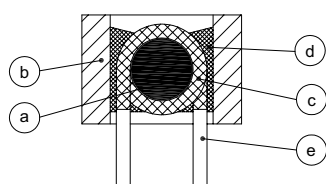

(a) Core : Iron Powder R Core

(b) Core : Iron Powder RI Core

(c) Wire : Enamelled Copper Wire

(d) Adhesive : Epoxy

(e) Terminal : Tinned Copper Plate

### 5. GENERAL SPECIFICATION :

a) Ambient temp. : 25°C

b) Irms(A) : Will cause temperature rise approximately 40°C without core loss

c) Isat(A) : Will cause L<sub>0</sub> to drop approximately 20%



**RoHS Compliant**

NOTE : Specifications subject to change without notice. Please check our website for latest information.

07.04.2008



**SUPERWORLD ELECTRONICS (S) PTE LTD**

PG. 1

### 6. ELECTRICAL CHARACTERISTICS :

Part No.	Inductance L <sub>0</sub> ( $\mu$ H)	Test Frequency (Hz)	DCR (m $\Omega$ ) $\pm 8\%$	I <sub>rms</sub> (A) Max.	I <sub>sat</sub> (A) Max.
SWDY1008-R47MF-NC	0.47 $\pm 20\%$	1.0V / 100K	0.87	36	45
SWDY1008-R60MF-NC	0.60 $\pm 20\%$	1.0V / 100K	0.87	36	45
SWDY1008-R80MF-NC	0.80 $\pm 20\%$	1.0V / 100K	1.30	30	45
SWDY1008-1R0MF-NC	1.00 $\pm 20\%$	1.0V / 100K	1.30	30	40

### 7. INDUCTANCE VS. DC BIAS CURVES :

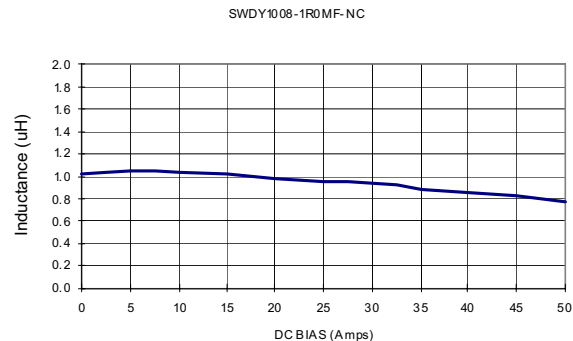
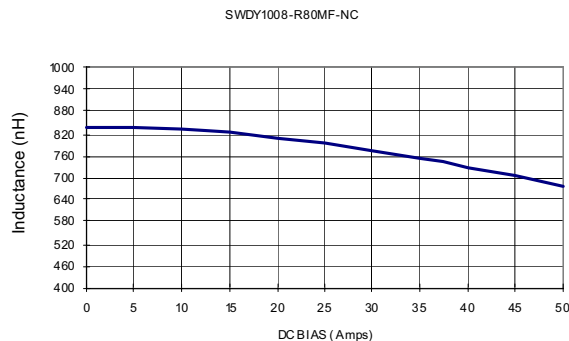
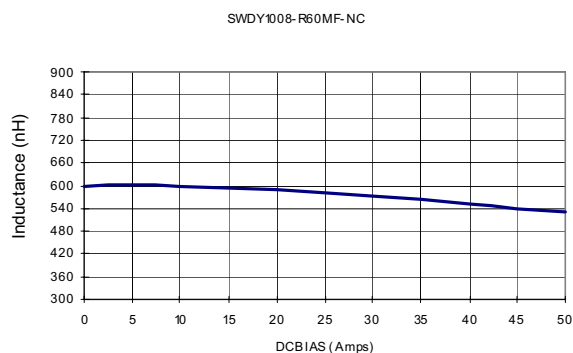
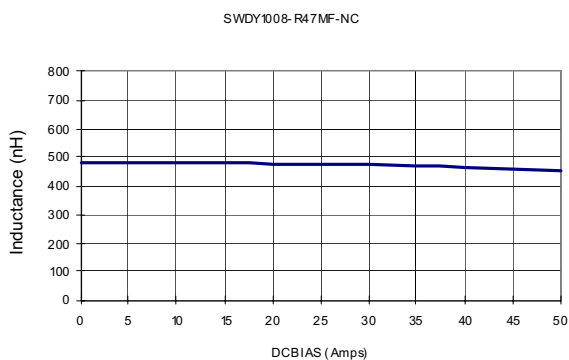

**RoHS Compliant**

NOTE : Specifications subject to change without notice. Please check our website for latest information.

07.04.2008



**SUPERWORLD ELECTRONICS (S) PTE LTD**

### 8. TEMPERATURE RISE VS DC BIAS CURVES : :

SWDY1008-R47MF-NC

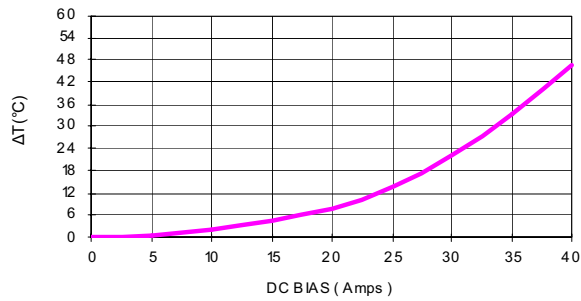

SWDY1008-R60MF-NC

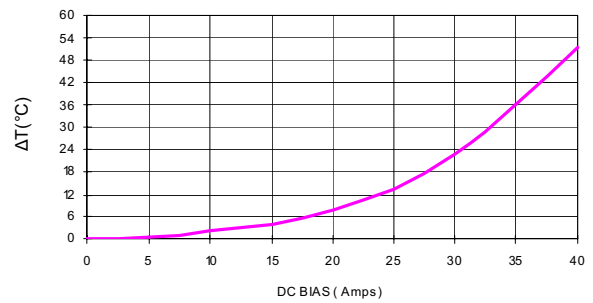

SWDY1008-R80MF-NC

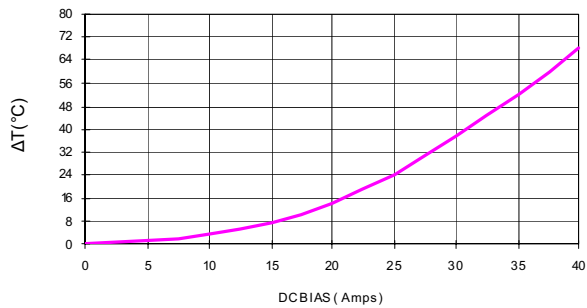

SWDY1008-1R0MF-NC

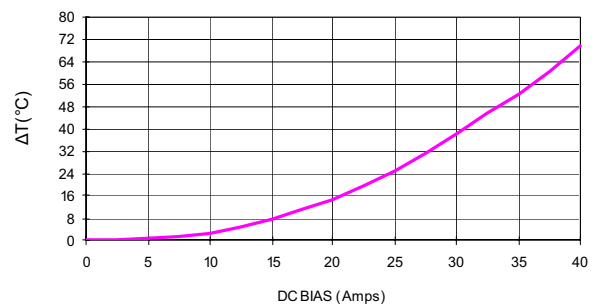

**RoHS Compliant**

NOTE : Specifications subject to change without notice. Please check our website for latest information.

07.04.2008



**SUPERWORLD ELECTRONICS (S) PTE LTD**