

ISDN S-Interface Transformers

Meets the Pulse Waveform Template of CCITT I.430 when recommended Transformer and Chip pair are used.

Excellent Longitudinal Balance $2kV_{RMS}$ & $4kV_{RMS}$ min. Isolation

Electrical Specifications ^{1,2,3,4} at 25°C

Isolation (Min.)		Turns Ratio (± 2%)	OCL min. Pri (mH)	L _L max. Sec. (µH)	C _{www} max. (pF)	CD pri. max. (pF)	DCR Pri. ± 15% (Ω)	DCR Sec. ± 15% (Ω)	Schem. Style
2000V _{RMS} Part. No.	4000V _{RMS} Part. No.								
T-10400	T-10450	1:1	22	5	100	40	2.4	2.4	A
T-10401	T-10451	1:1.8	22	15	100	140	2.5	4.2	B
T-10402	T-10452	1:2	22	15	100	80	2.3	4.0	A
T-10403	T-10453	1:2.5	22	30	100	150	2.5	5.8	B
T-10404	T-10454	1:2.5	22	15 / 40	100	110	2.5	5.8	C
T-10405	T-10455	1:2	22	11	100	180	2.5	5.0	A

1. Primary is Line Side
2. OCL: Primary Inductance @ 10 kHz and 700 mV
3. Unbalanced current at TE: Δ I_{dc} = 1 mA max.
4. Longitudinal Conversion Loss 10KHz to 300 KHz 60dB min.

Schematic "A"

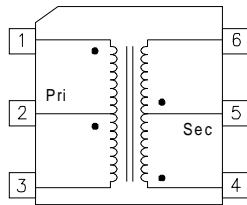

6-Pin Bottom View

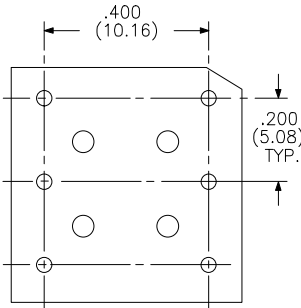

Schematic "B"

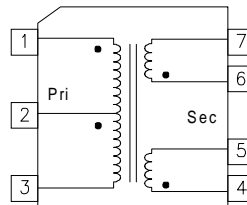

7-Pin Bottom View

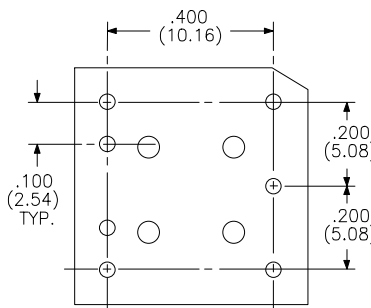

Schematic "C"

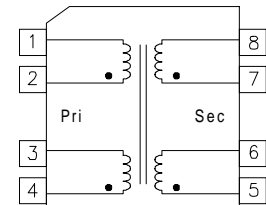

8-Pin Bottom View

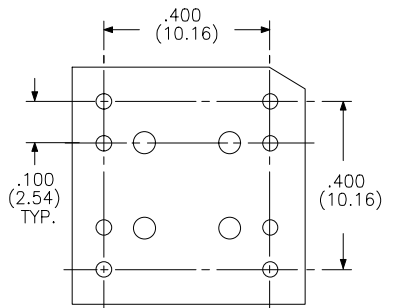

All of the above parts are available as Surface Mount components. For Surface Mount part number replace the second digit of thru hole part number with "3". (i.e. T-10400 = T-13400)

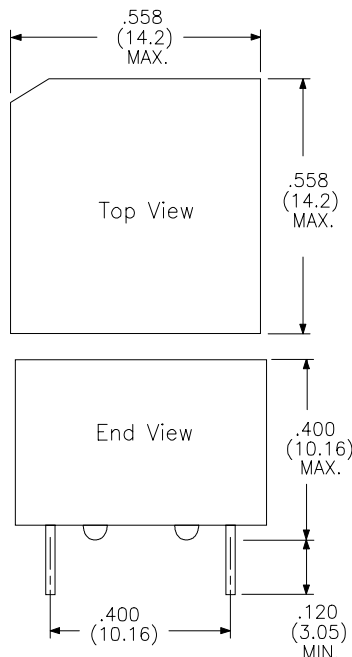

NOTE: Unused Pins Omitted as per Schematic Diagrams

