



Models Available

## Features/Benefits

- Compact size—small footprint
- Single and double pole models
- PC and panel mount options available

## Typical Applications

- Hand-held telecommunications
- Instrumentation
- Medical equipment

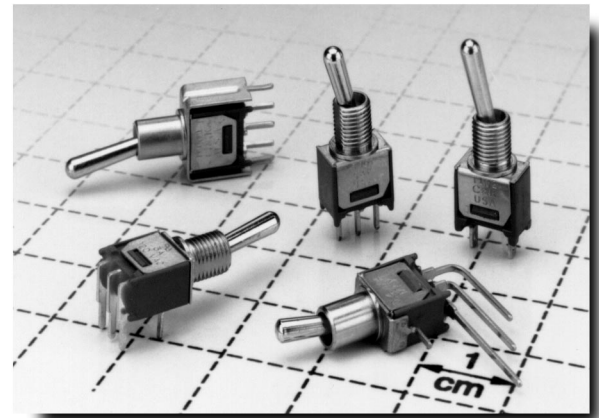

A

Toggle

## Build-A-Switch

Our easy Build-A-Switch concept allows you to mix and match options to create the switch you need. Below is a complete listing of options shown in catalog. To order, simply select desired option from each category and place in the appropriate box. Switches with standard options are shown on pages A-40 and A-41. Available options are shown and described on pages A-41 thru A-45. For additional options not shown in catalog, consult Customer Service Center. All models have epoxy terminal seal and are compatible with all "bottom-wash" PCB cleaning methods.

Typical Example: T 1 0 1 — S — H — Z — Q — E —  

### Switch Function

- T101** (STD.) SPDT On-None-On
- T103** (STD.) SPDT On-Off-On
- T105** (STD.) SPDT Mom.-Off-Mom.
- T201** (STD.) DPDT On-None-On
- T102** SPST Off-None-On
- T107** SPDT On-Off-Mom.
- T108** SPDT On-None-Mom.
- T203** DPDT On-Off-On
- T205** DPDT Mom.-Off-Mom.
- T207** DPDT On-Off-Mom.
- T208** DPDT On-None-Mom.
- T211** DPDT On-On-On

### Actuator

- M** (STD.) .210" high
- P3** (STD.) Flatted, anti-rotation, .450" high
- S** (STD.) .370" high
- K** Locking lever
- K1** Locking lever
- L** .290" high
- L1** .620" high
- M1** .220" high
- S1** .410" high

### Bushing

- H** (STD.) .220" high, threaded, flat
- H9** (STD.) .220" high, unthreaded, flat
- CF** Splashproof, .310" high, threaded, flat
- D9** .260" high, unthreaded, keyway
- K9** .310" high, unthreaded, keyway
- T** .310" high, threaded, flat
- T9** .310" high, unthreaded, flat
- TD** .260" high, threaded, keyway
- TK** .310" high, threaded, keyway
- Y** .220" high, threaded, keyway
- Y9** .220" high, unthreaded, keyway

### Terminations

- A** (STD.) Right angle, PC thru-hole
- AV** (STD.) Vertical right angle, PC thru-hole
- C** (STD.) PC Thru-hole
- V3** (STD.) Vertical mount V-bracket
- Z** (STD.) Solder lug
- W** Wire wrap

### Seal

- E** (STD.) Epoxy

### Contact Material

- B** (STD.) Gold
- Q** (STD.) Silver
- K** Gold
- M** Silver
- G** Gold over silver
- L** Gold over silver

### Locking Lever Actuator Finish

- NONE** (STD.) Natural aluminum
- 2** Black
- 3** Red
- 7** Blue

## Specifications

CONTACT RATING: B contact material: 0.4 VA max. @ 20 V AC or DC max. Q contact material (TX01 models): 3 AMPS @ 120 V AC or 28 V DC. All other models: 2 AMPS @ 120 V AC or 28 V DC. See page A-45 for additional ratings.

ELECTRICAL LIFE: TX01 models: 60,000 make-and-break cycles at full load. All other models: 30,000 cycles.

CONTACT RESISTANCE: Below 20 milliohms typ. initial @ 2-4 V DC, 100 mA, for both silver and gold plated contacts.

INSULATION RESISTANCE: 10<sup>9</sup> ohms min.

DIELECTRIC STRENGTH: 1000 V RMS min. @ sea level.

OPERATING TEMPERATURE: -30°C to 85°C.

SOLDERABILITY: Per MIL-STD-202F method 208D, or EIA RS-186E method 9 (1 hour steam aging).

**NOTE:** Specifications and materials listed above are for switches with standard options. For information on specific and custom switches, consult Customer Service Center.

## Materials

CASE: Glass filled nylon 6/6, flame retardant, heat stabilized or diallyl phthalate (DAP), (UL 94V-0).

ACTUATOR: Brass, chrome plated.

BUSHING: Brass, nickel plated.

HOUSING: Stainless steel.

SWITCH SUPPORT: Brass, tin plated.

END CONTACTS: B contact material: Copper alloy, with gold plate over nickel plate. Q contact material: Coin silver, silver plated. See page A-45 for additional contact materials.

CENTER CONTACTS & TERMINALS: B contact material: Copper alloy, with gold plate over nickel plate. Q contact material: Copper alloy, silver plated. See page A-45 for additional contact materials.

TERMINAL SEAL: Epoxy.

HARDWARE: Nut & Locking Ring: Brass, nickel plated.  
Lockwasher: Steel, nickel plated.



## SWITCH WITH STANDARD OPTIONS

PART NUMBER	NO. POLES	POS. 1	POS. 2	POS. 3
<b>T101MH9AVBE</b>	SPDT	ON	NONE	ON

NOTE: For PC mounting information, see page A-44.

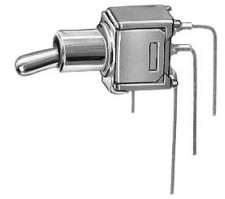
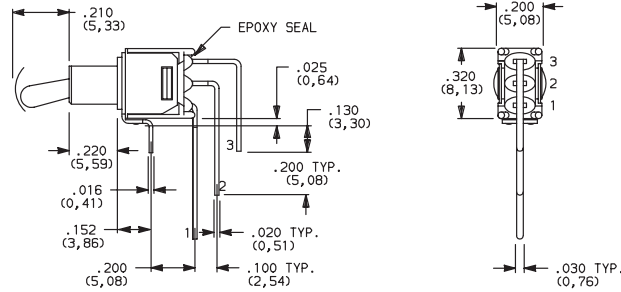

T101MH9AVBE  
Vertical Actuation  
SPDT



## SWITCH FUNCTION

NO. POLES	MODEL NO.	SWITCH FUNCTION			CONNECTED TERMINALS			SCHEMATIC
		POS. 1	POS. 2	POS. 3	POS. 1	POS. 2	POS. 3	
SP	<b>T101 (STD.)</b>	ON	NONE	ON	2-3	OPEN	2-1	
	<b>T103 (STD.)</b>	ON	OFF	ON				
	<b>T105 (STD.)</b>	MOM.	OFF	MOM.				
	<b>T107</b>	ON	OFF	MOM.				
	<b>T108</b>	ON	NONE	MOM.				
	<b>T102</b>	OFF	NONE	ON				
DP	<b>T201 (STD.)</b>	ON	NONE	ON	2-3,5-6	OPEN	2-1,5-4	
	<b>T203</b>	ON	OFF	ON				
	<b>T205</b>	MOM.	OFF	MOM.				
	<b>T207</b>	ON	OFF	MOM.				
	<b>T208</b>	ON	NONE	MOM.				
	<b>T211*</b>	ON	ON	ON				

MOM. = Momentary

\* Wiring for 3-way switch, see page L-29.

All models with all options when ordered with G, L, M or Q contact material.

## ACTUATOR

**M** (STD.) .210" HIGH

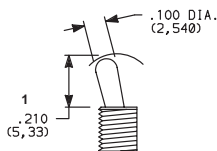

Standard with A, AV or V3 terminations.

**S** (STD.) .370" HIGH

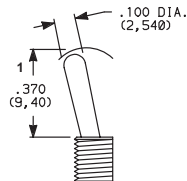

Standard with Z, C or W terminations.

**M1** .220" HIGH

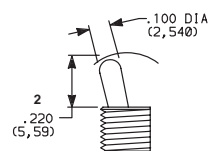

**S1** .410" HIGH

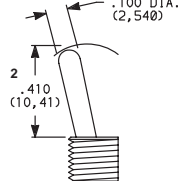

**L** .290" HIGH

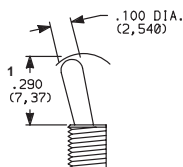

**L1** .620" HIGH

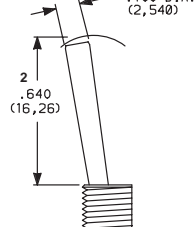

**P3 (STD.) ANTI-ROTATION, FLATTED, .450" HIGH**

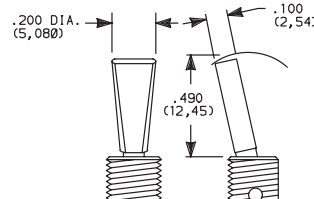

Available with T & T9 bushings only.

1 Actuator shown with standard H bushing. Subtract .040 (1,02) for TD and D9 bushings, subtract .090 (2,29) for T, T9, TK, K9 & CF bushings.

2 Actuators shown with T, TK & CF bushings, add .050 (1,27) for TD and D9 bushings, add .090 (2,29) for H, H9, Y & Y9 bushings.

NOTE: Dress nut part number 709901201 supplied standard with threaded bushing. All actuators have chrome finish (except K & K1). No finish selection required.

# T Series Subminiature Toggle Switches



Toggle  
A

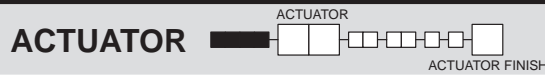

## K LOCKING LEVER

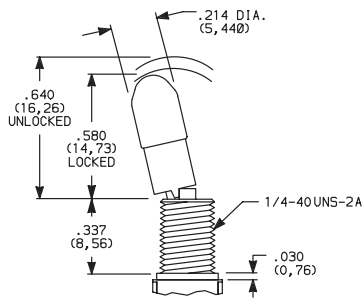

## K1 LOCKING LEVER

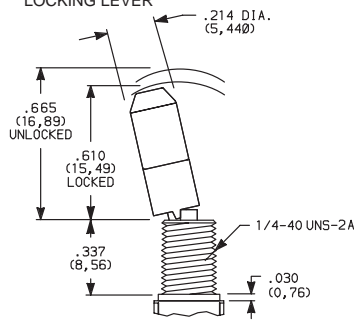

## Locking Positions



-01 & -02 Models  
2 Position lock



-03 & -11 Models  
3 Position lock



-08 Models  
1 Position lock

Not available with CF bushing option.

**NOTE:** Keyway on right side. To prevent accidental actuation, toggles must be lifted before being actuated. When released, toggles again lock in place. Overtightening mounting nut may cause actuator to bind.

Bushing option code not required. Not available with TX05 & TX07 models.

OPTION CODE	K & K1 ACTUATOR CAP FINISH
NONE	(STD.) NATURAL AL.
2	BLACK ANODIZED AL.
3	RED ANODIZED AL.
7	BLUE ANODIZED AL.

## BUSHING

### H (STD.) .220" HIGH THREADED, FLAT

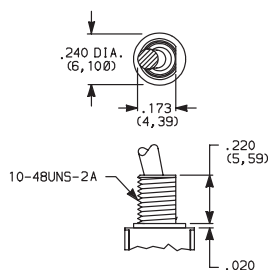

H standard with C, W & Z terminations.  
H9 standard with A, AV & V3 terminations.

### Y .220" HIGH THREADED, KEYWAY

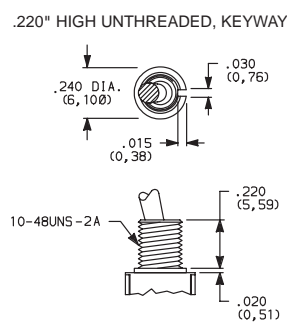

### T .310" HIGH THREADED, FLAT

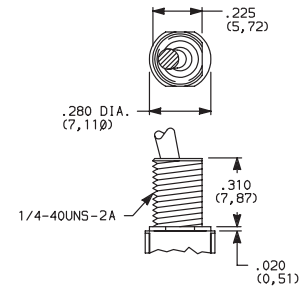

### TK .310" HIGH THREADED, KEYWAY

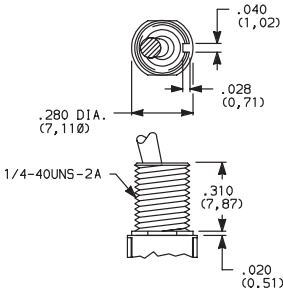

### TD .260" HIGH THREADED, KEYWAY

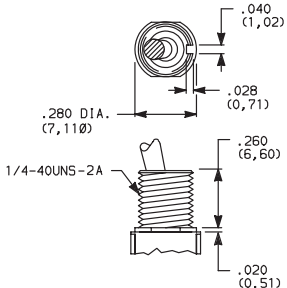

### CF SPLASHPROOF, .310" HIGH THREADED, FLAT

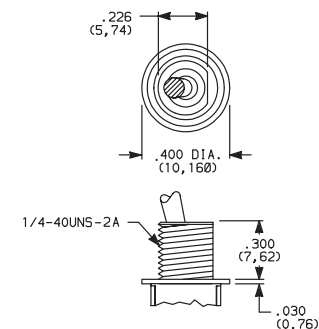

IP67 Degree of protection.  
Internal o-ring actuator seal and external bushing seal washer standard.

Not available with K Locking lever option.

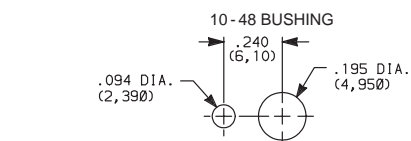

With Standard Locking Ring

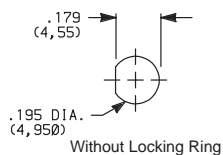

Without Locking Ring

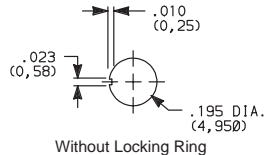

Without Locking Ring

### PANEL MOUNTING

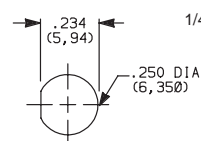

With Standard Locking Ring

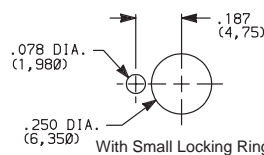

With Small Locking Ring

### 1/4 IN. BUSHING

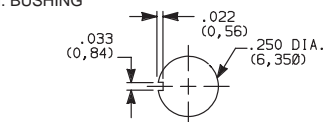

With Standard Locking Ring

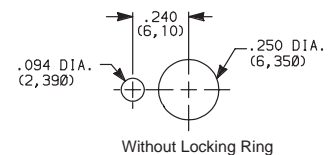

Without Locking Ring

## TERMINATIONS



A

Toggle

### Z (STD.) SOLDER LUG

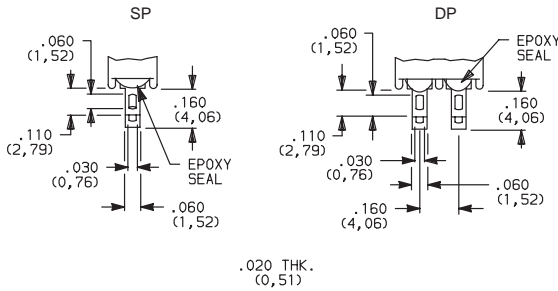

Not available with K, L or M contact materials.

### C (STD.) PC THRU-HOLE

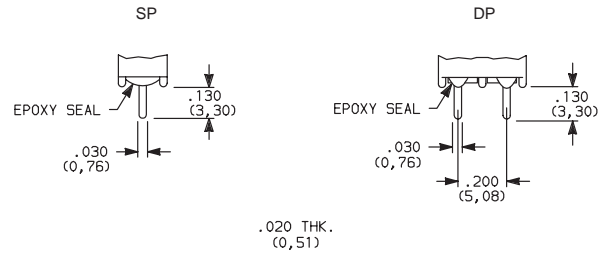

### W WIRE WRAP

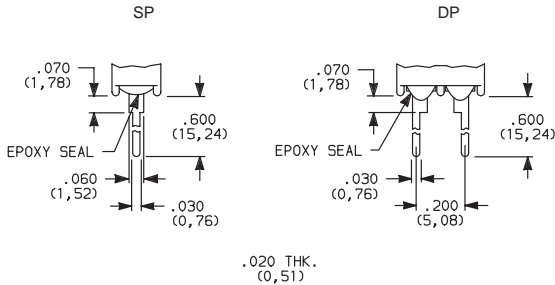

### PC MOUNTING

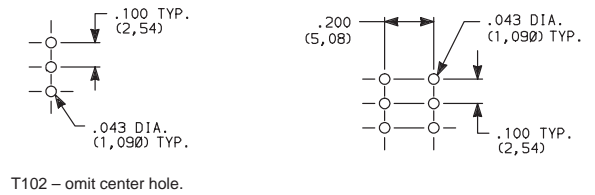

### A (STD.) RIGHT ANGLE, PC THRU-HOLE

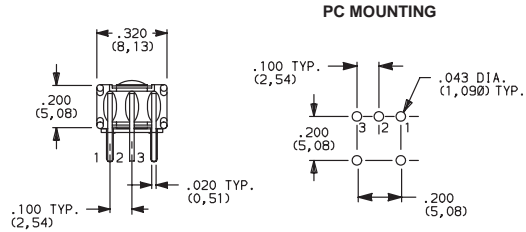
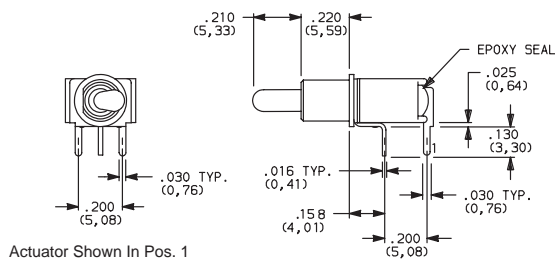

**T101MH9ABE**  
Horizontal Actuation  
**SPDT**

Not available with T102 model.

### A (STD.) RIGHT ANGLE, PC THRU-HOLE

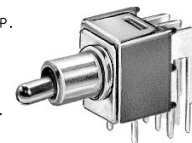
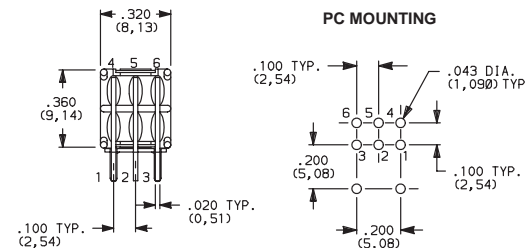
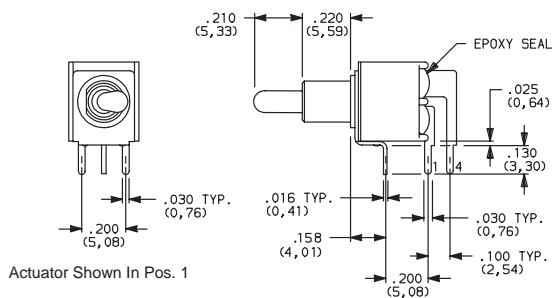

**T201MH9ABE**  
Horizontal Actuation  
**DPDT**

# T Series Subminiature Toggle Switches



## TERMINATIONS

**AV** (STD.) VERTICAL RIGHT ANGLE, PC THRU-HOLE

**A**

**Toggle**

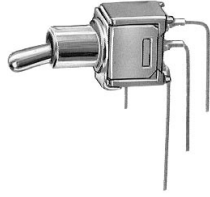

**T101MH9AVBE**  
Vertical Actuation  
**SPDT**

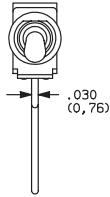

Actuator Shown In Pos. 1

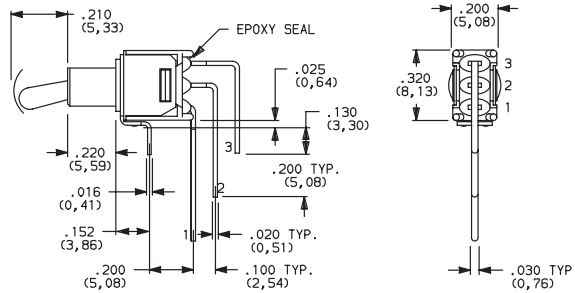

T102 Models: Omit terminal 2

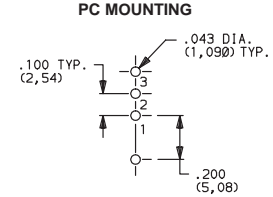

**NOTE:** Terminal bend radii and lead-in manufacturing option.

**AV** (STD.) VERTICAL RIGHT ANGLE, PC THRU-HOLE

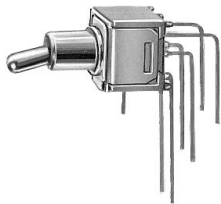

**T201MH9AVBE**  
Vertical Actuation  
**DPDT**

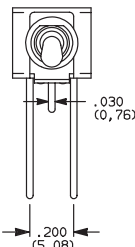

Actuator Shown In Pos. 1

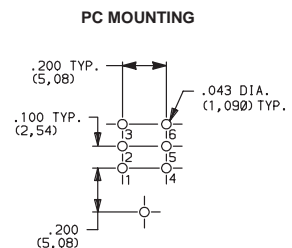
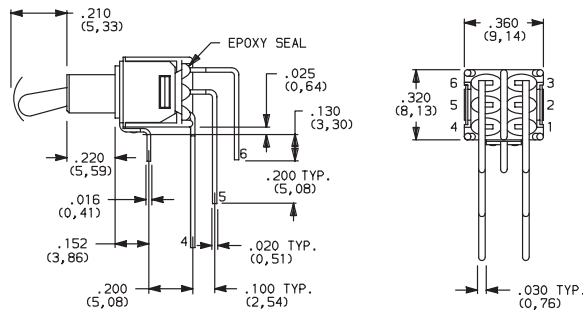

**NOTE:** Terminal bend radii and lead-in manufacturing option.

**V3** (STD.) VERTICAL MOUNT, V-BRACKET



**T101MH9V3BE**  
**SPDT**

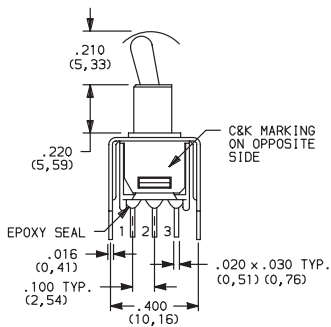

Actuator Shown In Pos. 1

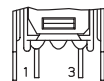

T102 Models:  
Omit terminal 2

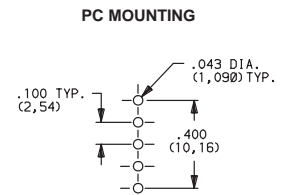

T102 Models:  
Omit center hole.

