

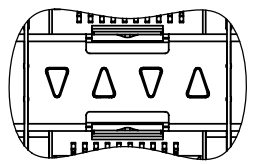

REVISIONS			
REV	DESCRIPTION	DATE	APPRD
G	LIGHT PIPE CONFIGURATION ADDED	MAY21/09	
H	PART NUMBERS UPDATED	JUL27/09	

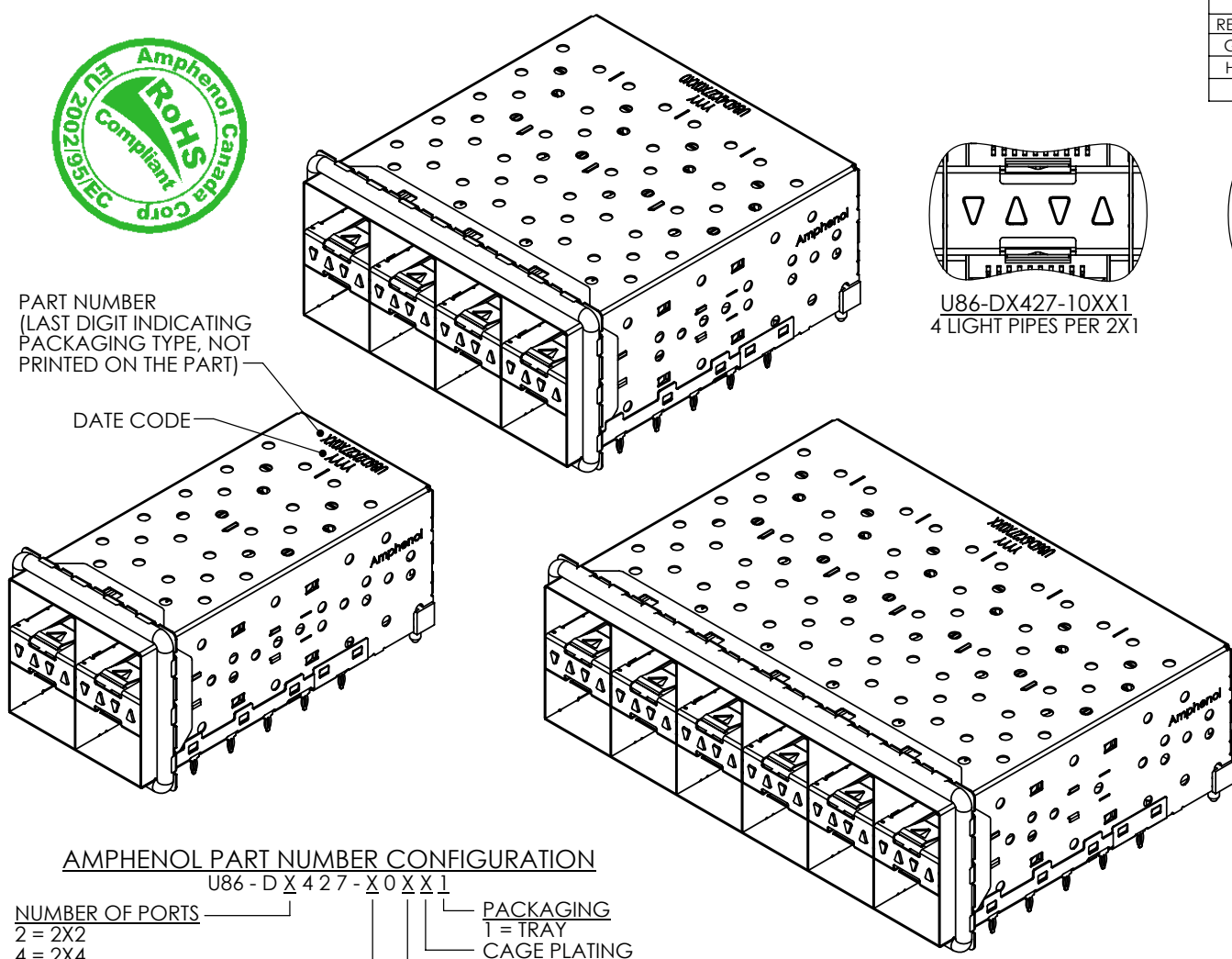

U86-DX427-10XX1
4 LIGHT PIPES PER 2X1

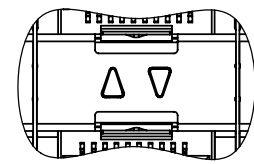

U86-DX427-20XX1
2 INNER LIGHT PIPES PER 2X1

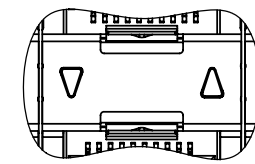

U86-DX427-30XX1
2 OUTER LIGHT PIPES PER 2X1

PART NUMBER
(LAST DIGIT INDICATING
PACKAGING TYPE, NOT
PRINTED ON THE PART)

DATE CODE

- MATERIAL: (RoHS COMPLIANT)
- CAGE - PRESS FIT:
COPPER ALLOY
- PLATING:
SEE AMPHENOL PART NUMBER
CONFIGURATION FOR OPTIONS.
- CONNECTOR - PRESS FIT:
- PLASTIC HOUSING:
LCP, FLAMMABILITY RATING UL94-0.
- CONTACTS:
PHOSPHOR BRONZE
PLATING OPTION: NICKEL 2.54 µm MIN.
- LIGHT PIPE:
CLEAR POLYCARBONATE, FLAMMABILITY
RATING UL94-0.
- PACKAGING:
TRAY PACKAGING.
- TEMPERATURE RANGE:
-40°C TO +85°C

AMPHENOL PART NUMBER CONFIGURATION

U86 - D X 4 2 7 - X 0 X X 1

- NUMBER OF PORTS
 - 2 = 2X2
 - 4 = 2X4
 - 6 = 2X6
- LIGHT PIPE CONFIGURATION
 - 1 = 4 LIGHT PIPES PER 2X1
 - 2 = 2 INNER LIGHT PIPES PER 2X1
 - 3 = 2 OUTER LIGHT PIPES PER 2X1
- PACKAGING
 - 1 = TRAY
- CAGE PLATING
 - 2 = NICKEL
- PRESS FIT CONNECTOR PLATING
 - 1 = 0.76 µm MIN. GOLD ON MATING AREA
3.81-7.62 µm TIN/LEAD ON TERMINATION
 - 4 = 0.38 µm MIN. GOLD ON MATING AREA
3.81-7.62 µm TIN/LEAD ON TERMINATION

DO NOT SCALE DRAWING

THIS DOCUMENT CONTAINS PROPRIETARY INFORMATION AND SUCH INFORMATION MAY NOT BE DISCLOSED TO OTHERS FOR ANY PURPOSE OR USED FOR MANUFACTURING PURPOSES WITHOUT PERMISSION FROM AMPHENOL CANADA CORP.

UNLESS OTHERWISE SPECIFIED DIMENSIONS ARE IN MILLIMETERS TOLERANCES ARE:		APPROVALS		DATE		Amphenol Canada Corp.	
DECIMALS	ANGLES	DRAWN	J.SI	FEB23/09	TITLE		
X.X ± 0.25	± 1°	DESIGNED	J.SI	FEB23/09	2XN SFP+ EXPRESSPORT™ COMBO WITH LIGHT PIPE (ELASTOMERIC GASKET)		
MATERIAL AND FINISH		CHECKED	X	X			
REF.	X	QA APPD	X	X	SIZE A4		
CODE IDENT. NO.	03554	IE APPD	X	X	DWG. NO. P-U86-DX427-X0XX1		
		DWG APPD			SCALE 1:1		
					PROJECT		
					SHEET 1 OF 6		

REVISIONS			
REV	DESCRIPTION	DATE	APPRD
G	LIGHT PIPE CONFIGURATION ADDED	MAY21/09	
H	PART NUMBERS UPDATED	JUL27/09	

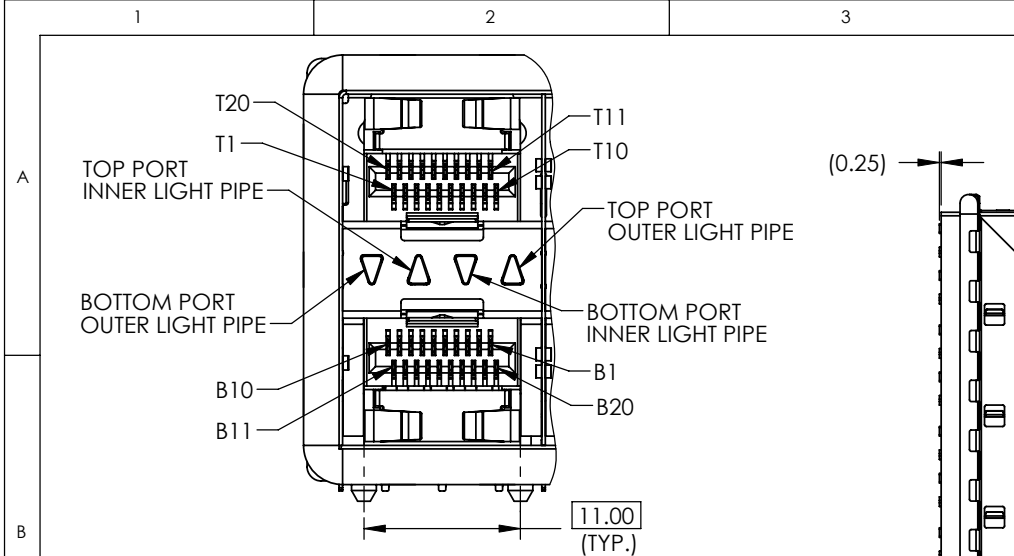

DETAIL A
SCALE 2 : 1

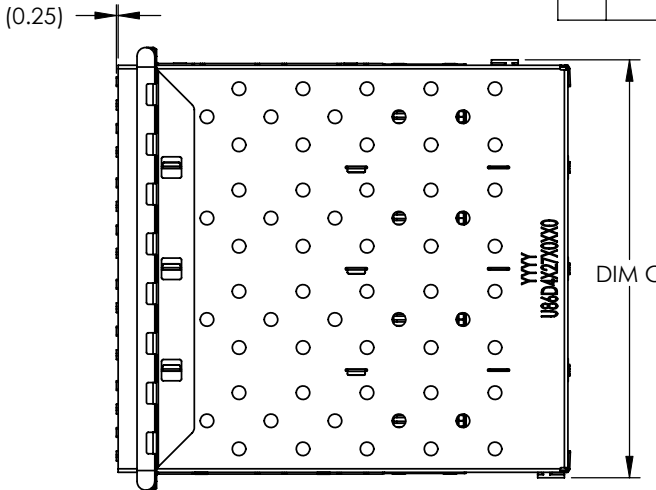

SFP COMBO	DIM A	DIM B	DIM C
2X2 SFP	28.25	33.75	30.25
2X4 SFP	56.75	62.25	58.75
2X6 SFP	85.25	90.75	87.25

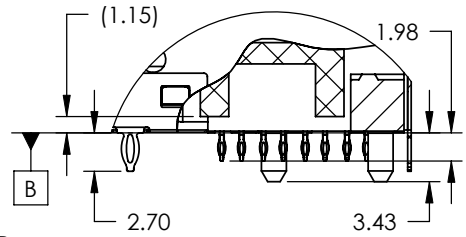
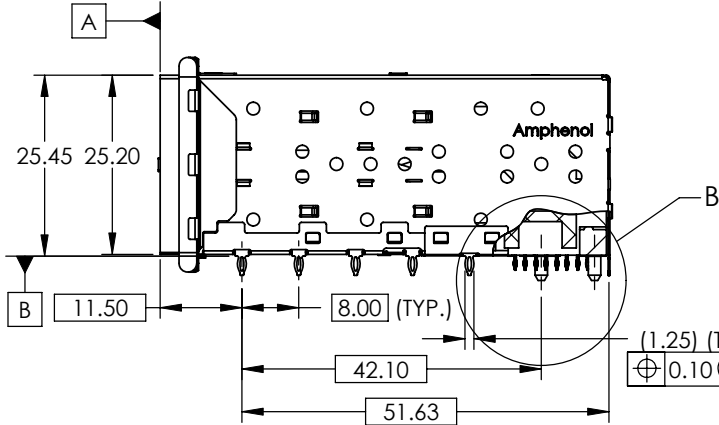
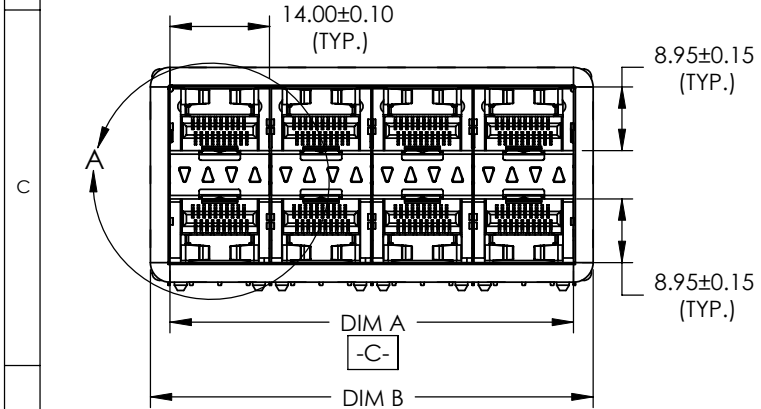

DETAIL B
SCALE 2 : 1

$\oplus 0.10$	\textcircled{M}	\textcircled{C}	\textcircled{A}	\textcircled{B}
---------------	-------------------	-------------------	-------------------	-------------------

DO NOT SCALE DRAWING

THIS DOCUMENT CONTAINS PROPRIETARY INFORMATION AND SUCH INFORMATION MAY NOT BE DISCLOSED TO OTHERS FOR ANY PURPOSE OR USED FOR MANUFACTURING PURPOSES WITHOUT PERMISSION FROM AMPHENOL CANADA CORP.

UNLESS OTHERWISE SPECIFIED DIMENSIONS ARE IN MILLIMETERS TOLERANCES ARE:		APPROVALS		DATE
DECIMALS	ANGLES	DRAWN	J.SI	FEB23/09
X.X ± 0.25	± 1°	DESIGNED	J.SI	FEB23/09
X.XX ± 0.15		CHECKED	X	X
MATERIAL AND FINISH	N/A	QA APPD	X	X
REF.	X	IE APPD	X	X
CODE IDENT. NO.	03554	DWG APPD		

Amphenol Canada Corp.			
TITLE			
2XN SFP+ EXPRESSPORT™ COMBO WITH LIGHT PIPE (ELASTOMERIC GASKET)			
SIZE	DWG. NO.	REV.	
A4	P-U86-DX427-X0XX1	H	
SCALE	PROJECT	SHEET	
1:1		2 OF 6	

REVISIONS			
REV	DESCRIPTION	DATE	APPRD
G	LIGHT PIPE CONFIGURATION ADDED	MAY21/09	
H	PART NUMBERS UPDATED	JUL27/09	

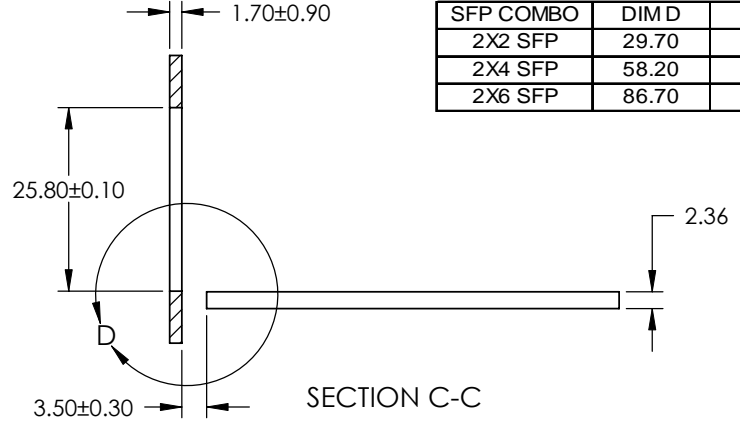
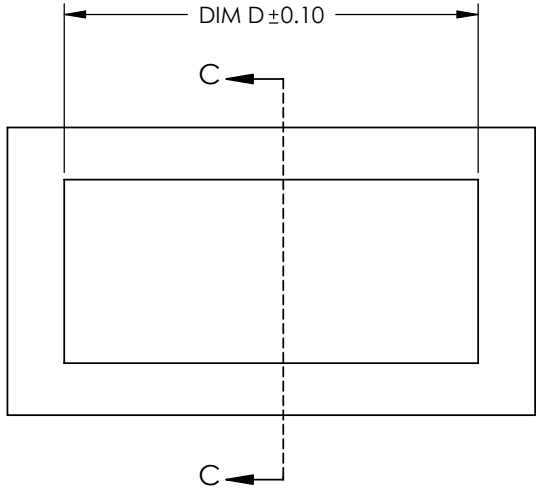

SFP COMBO	DIM D	DIM E
2X2 SFP	29.70	35.20
2X4 SFP	58.20	63.70
2X6 SFP	86.70	92.20

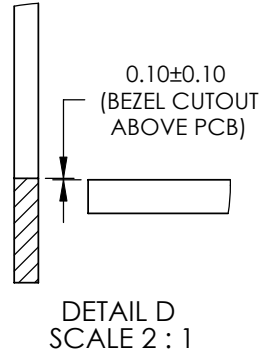
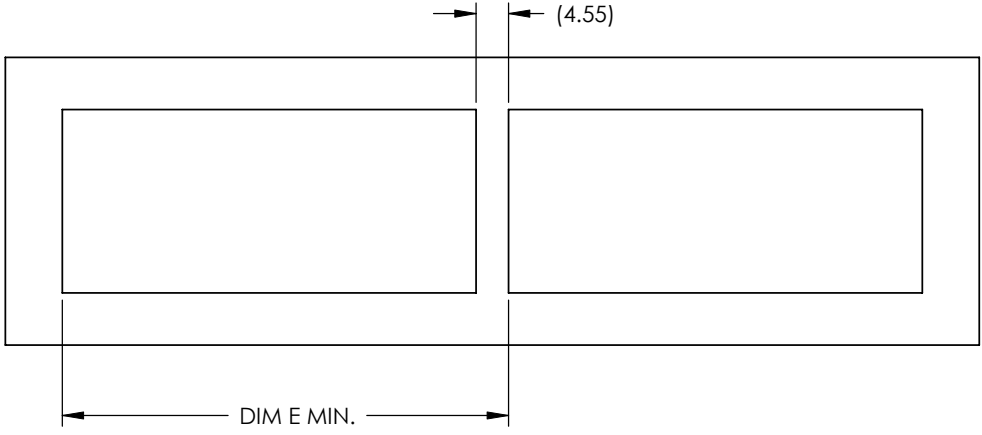

UNLESS OTHERWISE SPECIFIED DIMENSIONS ARE IN MILLIMETERS TOLERANCES ARE:		APPROVALS		DATE	
DECIMALS	ANGLES	DRAWN	J.SI	FEB23/09	
X.X ± 0.25	± 1°	DESIGNED	J.SI	FEB23/09	
X.XX ± 0.15		CHECKED	X	X	
MATERIAL AND FINISH	N/A	QA APPD	X	X	
REF.	X	IE APPD	X	X	
CODE IDENT. NO.	03554	DWG APPD			

Amphenol Canada Corp.					
TITLE					
2XN SFP+ EXPRESSPORT™ COMBO WITH LIGHT PIPE (ELASTOMERIC GASKET)					
SIZE	DWG. NO.	P-U86-DX427-X0XX1		REV.	H
SCALE	1:1	PROJECT	SHEET		3 OF 6

DO NOT SCALE DRAWING

THIS DOCUMENT CONTAINS PROPRIETARY INFORMATION AND SUCH INFORMATION MAY NOT BE DISCLOSED TO OTHERS FOR ANY PURPOSE OR USED FOR MANUFACTURING PURPOSES WITHOUT PERMISSION FROM AMPHENOL CANADA CORP.

REVISIONS			
REV	DESCRIPTION	DATE	APPRD
G	LIGHT PIPE CONFIGURATION ADDED	MAY21/09	
H	PART NUMBERS UPDATED	JUL27/09	

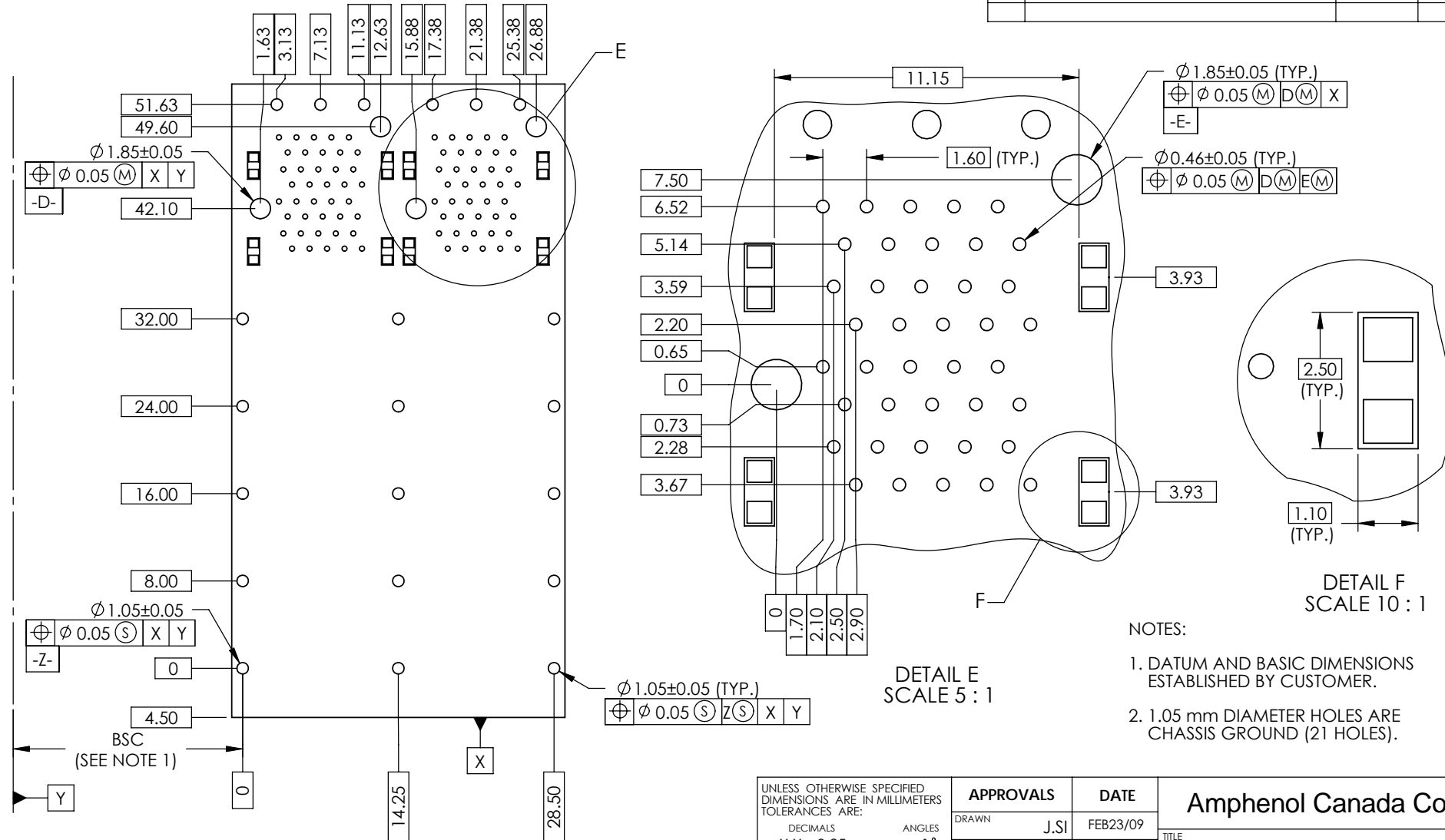

- NOTES:
- DATUM AND BASIC DIMENSIONS ESTABLISHED BY CUSTOMER.
 - 1.05 mm DIAMETER HOLES ARE CHASSIS GROUND (21 HOLES).

DETAIL E
SCALE 5 : 1

DETAIL F
SCALE 10 : 1

DO NOT SCALE DRAWING

THIS DOCUMENT CONTAINS PROPRIETARY INFORMATION AND SUCH INFORMATION MAY NOT BE DISCLOSED TO OTHERS FOR ANY PURPOSE OR USED FOR MANUFACTURING PURPOSES WITHOUT PERMISSION FROM AMPHENOL CANADA CORP.

UNLESS OTHERWISE SPECIFIED DIMENSIONS ARE IN MILLIMETERS TOLERANCES ARE:		APPROVALS		DATE		Amphenol Canada Corp.	
DECIMALS	ANGLES	DRAWN	J.SI	FEB23/09	TITLE		
X.X ± 0.25	± 1°	DESIGNED	J.SI	FEB23/09	2XN SFP+ EXPRESSPORT™ COMBO WITH LIGHT PIPE (ELASTOMERIC GASKET)		
X.XX ± 0.15		CHECKED	X	X	SIZE A4 DWG. NO. P-U86-DX427-X0XX1 REV. H		
MATERIAL AND FINISH	N/A	QA APPD	X	X	SCALE 2:1 PROJECT SHEET 4 OF 6		
REF.	X	IE APPD	X	X			
CODE IDENT. NO.	03554	DWG APPD					

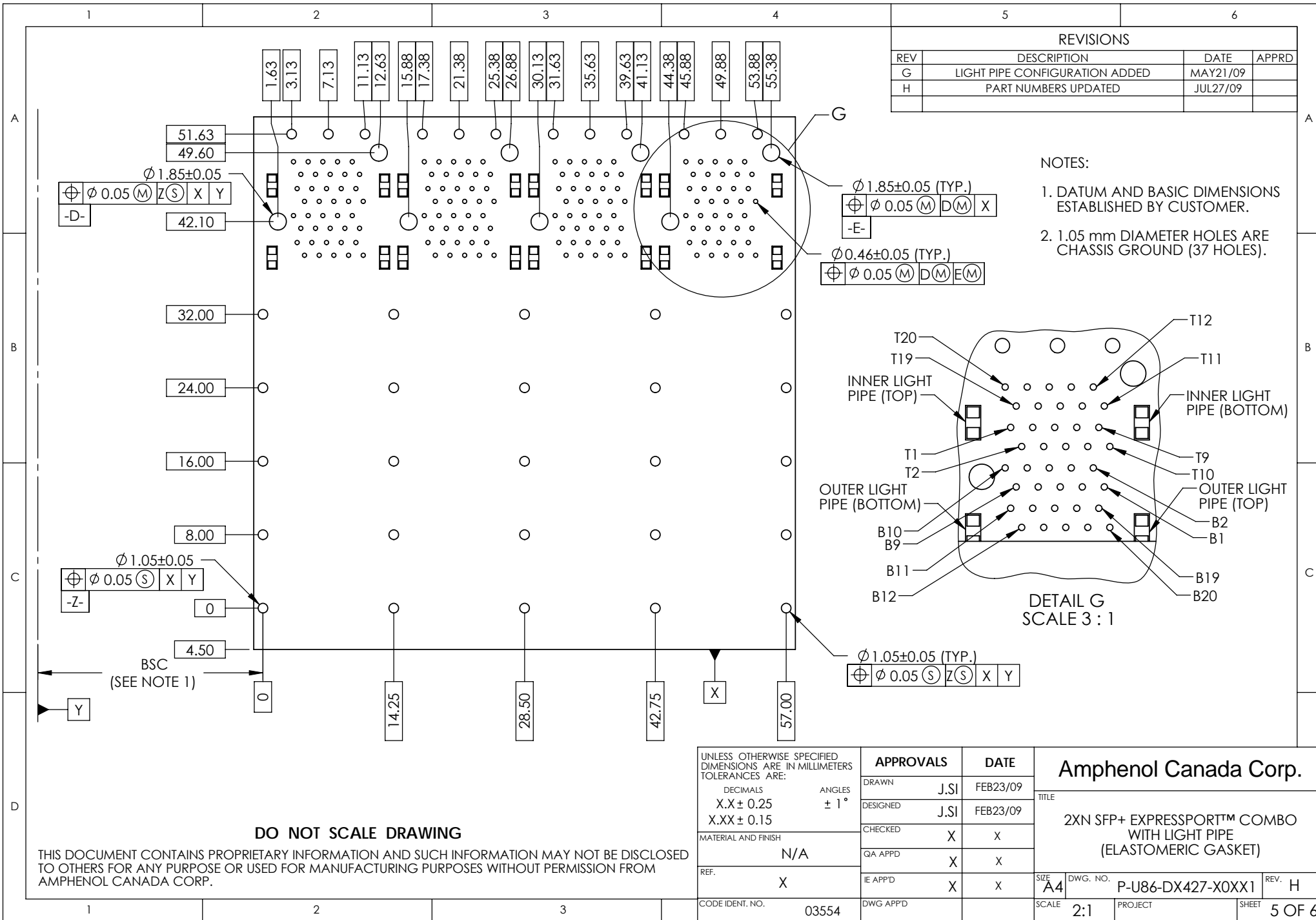

REVISIONS			
REV	DESCRIPTION	DATE	APPRD
G	LIGHT PIPE CONFIGURATION ADDED	MAY21/09	
H	PART NUMBERS UPDATED	JUL27/09	

- NOTES:
- DATUM AND BASIC DIMENSIONS ESTABLISHED BY CUSTOMER.
 - 1.05 mm DIAMETER HOLES ARE CHASSIS GROUND (37 HOLES).

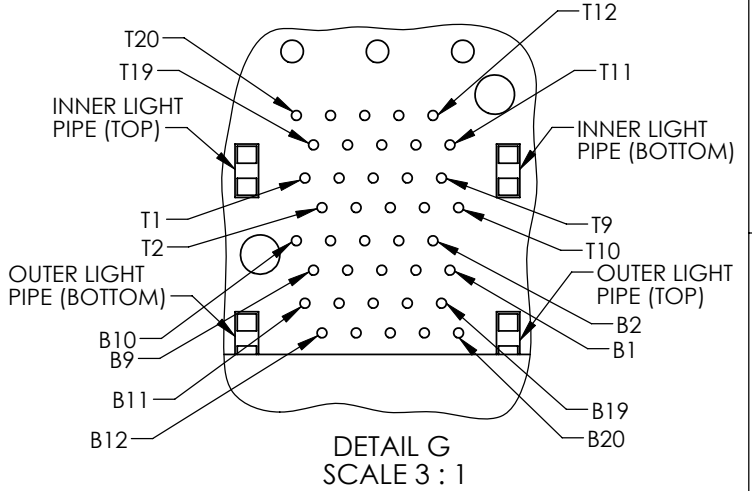

UNLESS OTHERWISE SPECIFIED DIMENSIONS ARE IN MILLIMETERS TOLERANCES ARE:		APPROVALS		DATE	
DECIMALS	ANGLES	DRAWN	J.SI	FEB23/09	
X.X ± 0.25	± 1°	DESIGNED	J.SI	FEB23/09	
X.XX ± 0.15		CHECKED	X	X	
MATERIAL AND FINISH	N/A	QA APPD	X	X	
REF.	X	IE APPD	X	X	
CODE IDENT. NO.	03554	DWG APPD			

Amphenol Canada Corp.			
TITLE			
2XN SFP+ EXPRESSPORT™ COMBO WITH LIGHT PIPE (ELASTOMERIC GASKET)			
SIZE	DWG. NO.	P-U86-DX427-X0XX1	REV. H
A4	SCALE	2:1	PROJECT SHEET
			5 OF 6

DO NOT SCALE DRAWING

THIS DOCUMENT CONTAINS PROPRIETARY INFORMATION AND SUCH INFORMATION MAY NOT BE DISCLOSED TO OTHERS FOR ANY PURPOSE OR USED FOR MANUFACTURING PURPOSES WITHOUT PERMISSION FROM AMPHENOL CANADA CORP.

REVISIONS			
REV	DESCRIPTION	DATE	APPRD
G	LIGHT PIPE CONFIGURATION ADDED	MAY21/09	
H	PART NUMBERS UPDATED	JUL27/09	

- NOTES:
- DATUM AND BASIC DIMENSIONS ESTABLISHED BY CUSTOMER.
 - 1.05 mm DIAMETER HOLES ARE CHASSIS GROUND (53 HOLES).

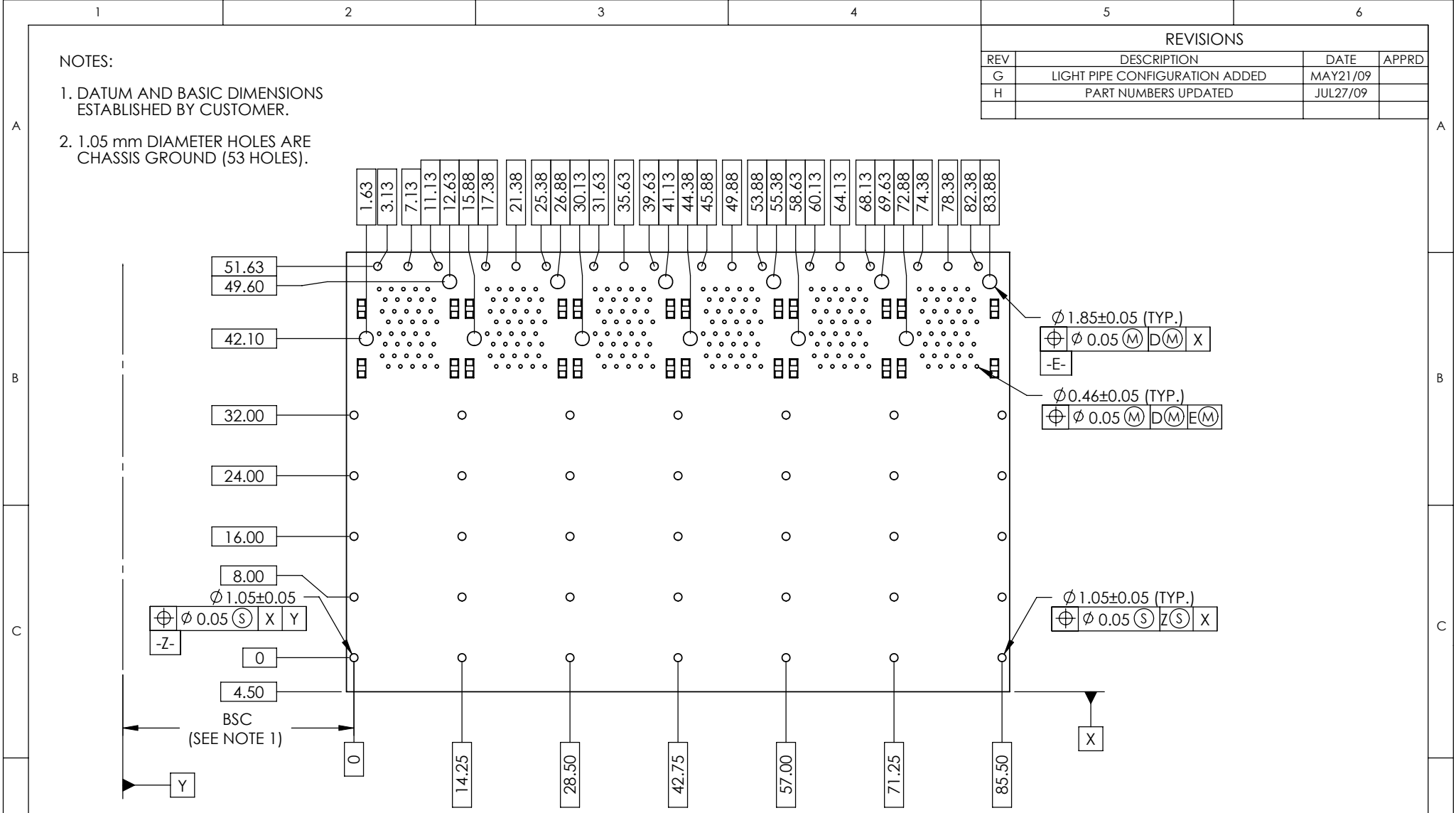

DO NOT SCALE DRAWING

THIS DOCUMENT CONTAINS PROPRIETARY INFORMATION AND SUCH INFORMATION MAY NOT BE DISCLOSED TO OTHERS FOR ANY PURPOSE OR USED FOR MANUFACTURING PURPOSES WITHOUT PERMISSION FROM AMPHENOL CANADA CORP.

UNLESS OTHERWISE SPECIFIED DIMENSIONS ARE IN MILLIMETERS TOLERANCES ARE: DECIMALS ANGLES X.X ± 0.25 ± 1° X.XX ± 0.15	APPROVALS		DATE
	DRAWN	J.SI	FEB23/09
	DESIGNED	J.SI	FEB23/09
	CHECKED	X	X
	QA APPD	X	X
MATERIAL AND FINISH	N/A		
REF.	X	IE APPD	X X
CODE IDENT. NO.	03554	DWG APPD	

Amphenol Canada Corp.			
TITLE			
2XN SFP+ EXPRESSPORT™ COMBO WITH LIGHT PIPE (ELASTOMERIC GASKET)			
SIZE	DWG. NO.	REV.	
A4	P-U86-DX427-X0XX1	H	
SCALE	PROJECT	SHEET	
3:2		6 OF 6	