

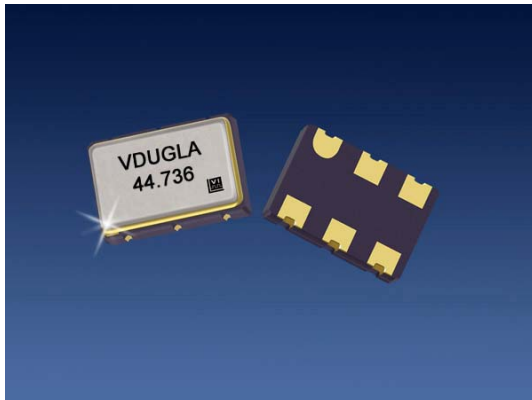

# V-Type Voltage Controlled Crystal Oscillator



The V-Type Voltage Controlled Crystal Oscillator

## Features

- Output frequencies to 80.000 MHz
- 5.0 or 3.3 V operation
- Tri-State Output
- Low jitter < 6ps rms
- VCXO with CMOS outputs
- APR to 100 ppm
- 0/70 or -40/85 °C temperature range
- Hermetically sealed ceramic SMD package

Product is compliant to RoHS directive  and fully compatible with lead free assembly

## Applications

- SONET/SDH
- DWDM
- xDSL/PCMCIA cards
- Digital Video

## Description

Vectron's V-Type Voltage Controlled Crystal Oscillator (VCXO) is a quartz stabilized square wave generator with a CMOS output and is tested at CMOS and TTL (5.0 volt operation) logic levels.

The V-Type's small footprint and low profile make it ideally suitable for PCMCIA applications as well as any other where size is limited but performance is required.

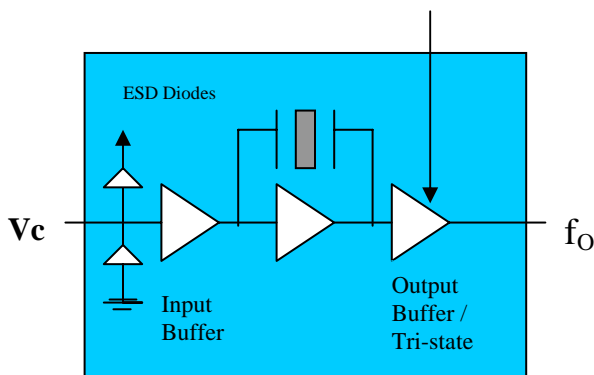

# V-Type Voltage Controlled Crystal Oscillator

## Performance Characteristics

Parameter	Symbol	Min	Typical	Maximum	Units
Frequency	$f_O$	1.024		80.000	MHz
Supply Voltage <sup>1</sup> (+3.3 V) (+5.0 V)	$V_{DD}$	2.97 4.5	3.3 5.0	3.63 5.5	V
Supply Current	$I_{DD}$		12	25	mA
Output Logic Levels Output Logic High <sup>2</sup> Output Logic Low <sup>2</sup>	$V_{OH}$ $V_{OL}$	$0.9 \cdot V_{DD}$		$0.1 V_{DD}$	V V
Transition Times Rise Time <sup>2</sup> Fall Time <sup>2</sup>	$t_R$ $t_F$		1 1	3 3	ns ns
Tristate Output Enabled Output Disabled	$V_{IN}$ $V_{IL}$	2.5		0.7	V V
Duty Cycle <sup>3</sup> (ordering option)	SYM		40/60 or 45/55		%
Operating temperature (ordering option)			0/70 or -40/85		°C
Test Conditions for APR (+5V option)	$V_C$	0.5		4.5	V
Test Conditions for APR (+3.3V option)	$V_C$	0.3		3.0	V
Absolute Pull Range (ordering option)	APR	±50 ±70 ±80 ±100			ppm
Gain Transfer (See Figure 3)			Positive		ppm/V
Control Voltage Leakage Current	$I_{VCXO}$			±1	uA
Control Voltage Bandwidth (-3dB)	BW	10			kHz
Phase Noise 10 Hz Offset 100 Hz Offset 1 KHz Offset 10 KHz Offset 100 KHz Offset 1 MHz Offset			-55 -85 -115 -142 -148 -151		dBc/Hz dBc/Hz dBc/Hz dBc/Hz dBc/Hz dBc/Hz
Package Size			7.49 x 5.08 x 1.8		mm

1. A 0.01uF and a 0.1uF capacitor should be located as close to the supply as possible (to ground) is recommended.
2. Figure 1 defines these parameters. Figure 2 illustrates the equivalent five gate TTL load and operating conditions under which these parameters are tested and specified.
3. Symmetry is defined as (ON TIME/PERIOD with  $V_S = 1.4$  V for TTL and  $V_S = 2.5$  V for CMOS, 5 volt operation, and  $V_S = 1.65$  V for 3.3 Volt operation.

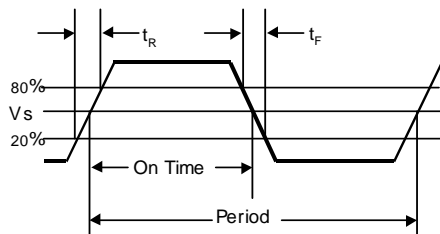

Figure 1. Output Waveform

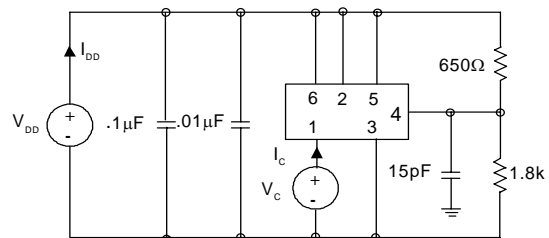
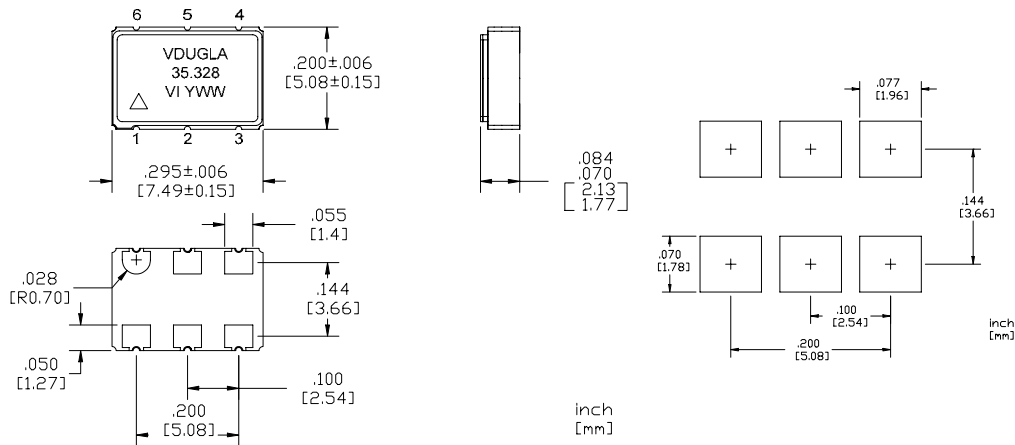

Figure 2. Typical Output Test Conditions (25±5°C)

# V-Type Voltage Controlled Crystal Oscillator

## Outline Diagram, Pad Layout and Pin Out



Pin #	Symbol	Function
1	$V_C$	Control Voltage
2	Tri-state or N/C (ordering option)	Logic low disables output Logic high or no connection enables output waveform
3	GND	Ground
4	$f_o$	Output Frequency
5	Tri-state or N/C (ordering option)	Logic low disables output Logic high or no connection enables output waveform
6	$V_{DD}$	Supply Voltage

## Tape and Reel

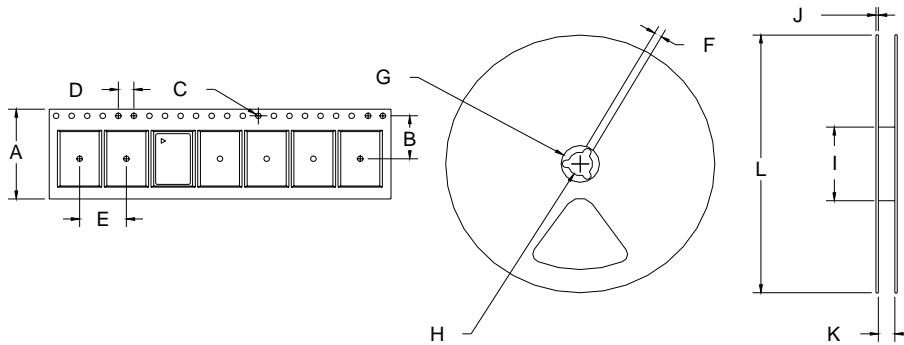

Tape and Reel Dimensions (mm)													
Tape Dimensions					Reel Dimensions								# Per Reel
Product	A	B	C	D	E	F	G	H	I	J	K	L	Reel
V-Type	16	7.5	1.55	4	8	1.78	20.6	13	55	6	12.4	178	500

# V-Type Voltage Controlled Crystal Oscillator

## Absolute Maximum Ratings

Stresses in excess of the absolute maximum ratings can permanently damage the device. Functional operation is not implied at these or any other conditions in excess of conditions represented in the operational sections of this data sheet. Exposure to absolute maximum ratings for extended periods may adversely affect device reliability.

**Table 2. Absolute Maximum Ratings**

Parameter	Symbol	Ratings	Unit
Power Supply	$V_{DD}$	6	Vdc
Storage Temperature	Tstorage	-55/125	°C
Voltage Control Range	$V_C$	0 to $V_{DD}$	V

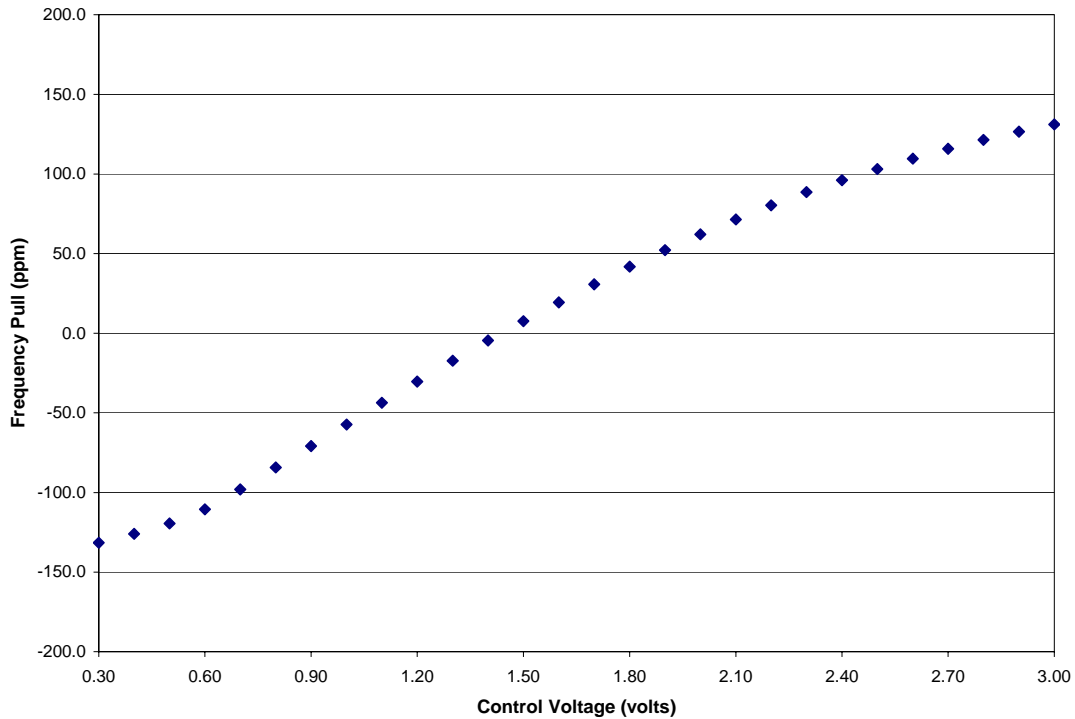

**Figure 3. Typical Frequency Pull Versus Control Voltage, 35.328MHz Output, 3.3 Volt Supply**

# V-Type Voltage Controlled Crystal Oscillator

## Reliability

The V-Type is capable of meeting the following qualification tests.

**Table 3. Environmental Compliance**

Parameter	Conditions
Mechanical Shock	MIL-STD-883 Method 2002
Mechanical Vibration	MIL-STD-883 Method 2007
Solderability	MIL-STD-883 Method 2003
Gross and Fine Leak	MIL-STD-883 Method 1014
Resistance to Solvents	MIL-STD-883 Method 2016

## Handling Precautions

Although ESD protection circuitry has been designed into the the V-Type, proper precautions should be taken when handling and mounting. VI employs a Human Body Model and a Charged-Device Model (CDM) for ESD susceptibility testing and design protection evaluation. ESD thresholds are dependent on the circuit parameters used to define the model. Although no industry wide standard has been adopted for the CDM, a standard HBM of resistance = 1.5kohms and capacitance = 100pF is widely used and therefore can be used for comparison purposes.

**Table 4. ESD Ratings**

Model	Minimum	Conditions
Human Body Model	1500	MIL-STD-883 Method 3115
Charged Device Model	1000	JESD 22-C101

The V-Type is qualified to meet the JEDEC standard for Pb-Free assembly. The temperatures and time intervals listed are based on the Pb-Free small body requirements and parameters are listed in the table below. The contact pads are gold over nickel so lower IR reflow temperatures such as 220°C can be used (device is backwards compatible with a lead solder assembly).

The V-Type is hermetically sealed so an aqueous wash is not an issue.

**Table 5. Reflow Profile (IPC/JEDEC J-STD-020C)**

Parameter	Symbol	Value
PreHeat Time	$t_s$	60 sec Min, 180 sec Max
Ramp Up	$R_{UP}$	3 °C/sec Max
Time Above 217 °C	$t_L$	60 sec Min, 150 sec Max
Time To Peak Temperature	$t_{AMB-P}$	480 sec Max
Time At 260 °C	$t_P$	20 sec Min, 40 sec Max
Ramp Down	$R_{DN}$	6 °C/sec Max

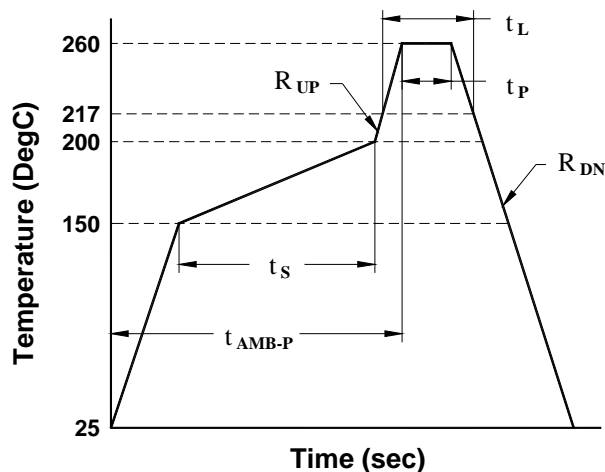

# V-Type Voltage Controlled Crystal Oscillator

## Standard Frequencies (MHz)

1.024	1.544	2.000	2.048	3.088	3.580	3.686
4.000	4.032	4.096	4.434	5.000	6.144	6.176
6.312	6.400	8.000	8.192	8.448	10.000	12.000
12.288	12.352	13.000	14.318	15.360	15.440	16.000
16.384	18.432	19.440	20.000	20.480	24.000	24.576
24.704	27.000	30.000	30.720	32.000	32.768	34.368
35.328	38.880	40.000	40.960	44.736	49.152	50.000
51.840	52.000	61.440	62.500	65.536	74.1758	74.250
77.760						

Other frequencies may be available upon request

## Ordering Information

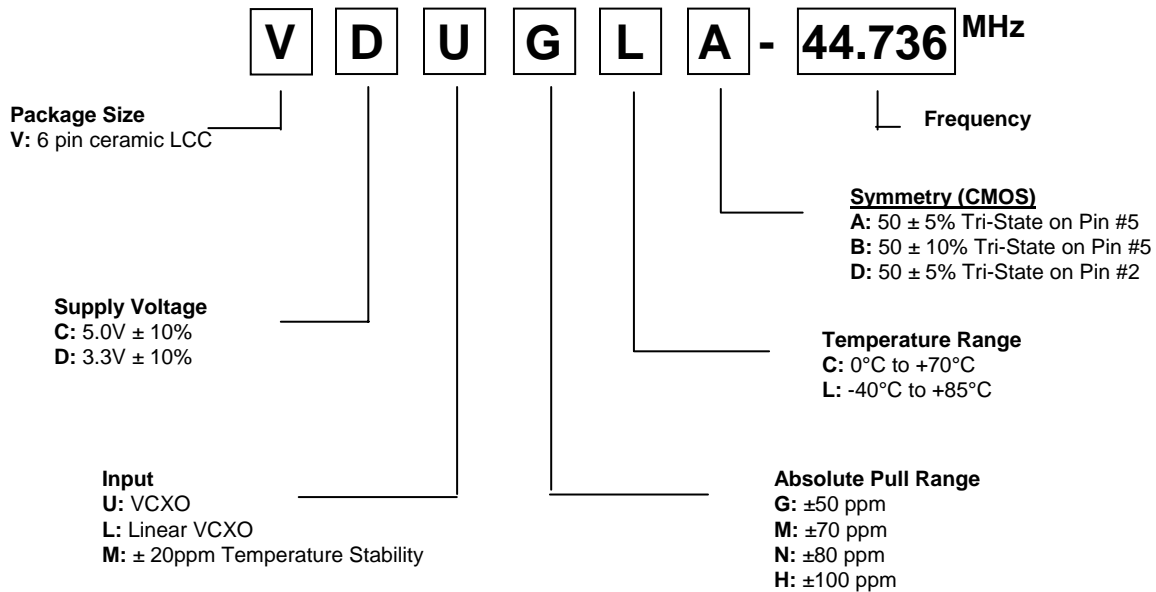

**NOTE: Not all combinations of options are available. Other specifications may be available upon request.**

## For Additional Information, Please Contact:



**USA:** Vectron International • 267 Lowell Road, Hudson, NH 03051

• Tel: 1-88-VECTRON-1 • Fax: 1-888-FAX-VECTRON

**EUROPE:** Landstrasse, D-74924, Neckarbischofsheim, Germany •

Tel: 49 (0) 7268 8010 • Fax: 49 (0) 7268 801281

**ASIA:** Vectron Asia Pacific Sales 1F-2F. No.8 Workshop No.308 Fenju Rd., WaiGaoQiao Free Trade Zone, Pudong New Area Shanghai, China 200131

•Tel: 8621 50480777 • Fax: 8621 50481881

Vectron International reserves the right to make changes to the product(s) and or information contained herein without notice. No liability is assumed as a result of their use or application. No rights under any patent accompany the sale of any such product(s) or information.