

# C&K 3 Series Thumbwheel Switches



## Features/Benefits

- Most complete product offering in the industry
- Spacers available to fit most panel cutouts
- Front or rear mounting options

## Typical Applications

- Test & measurement equipment
- Industrial equipment
- Computer devices

## Specifications

CONTACT RATING:  
 CARRY: 1 AMP continuous.  
 SWITCH: 100 mA max.  
 OPERATING VOLTAGE: 50 mV to 28 V DC or 120 V AC.  
 ELECTRICAL LIFE: 100,000 actuations.  
 CONTACT RESISTANCE: Below 100 m Ω typ. initial @  
 2-4 V DC, 100 mA.  
 INSULATION RESISTANCE: 10<sup>9</sup> Ω min.  
 DIELECTRIC STRENGTH: 500 Vrms min. @ sea level  
 between common terminal and any output.  
 OPERATING TEMPERATURE: -10°C to 65°C.

## Materials

HOUSING: ABS plastic.  
 THUMBWHEEL: ABS plastic.  
 ROTOR CONTACTS: Precious metal on copper alloy.  
 STATOR CONTACTS: Hard gold over nickel over copper  
 on epoxy fiberglass.

**NOTE:** Specifications and materials listed above are for switches with standard options. For information on specific and custom switches, consult Customer Service Center.

\* Note: All models listed are RoHS compliant. See Technical Data section of this catalog for RoHS compliant and compatible definitions and specifications.

## Build-A-Switch

To order, simply select desired option from each category and place in the appropriate box. Available options are shown and described on pages N-9 thru N-12. For additional options not shown in catalog, consult Customer Service Center. Consult factory for illumination availability.

Thumbwheel & Pushwheel

**Series**

**3** Thumbwheel switch

**Number of Sections**

**0** Switch section  
**1** 1 Switch section  
**2** 2 Switch sections  
**3** 3 Switch sections  
**4** 4 Switch sections  
**5** 5 Switch sections  
**6** 6 Switch sections  
**7** 7 Switch sections  
**8** 8 Switch sections  
**9** More than 8 switch sections

**Function Code**

**11** Decimal, SP, 10 position  
**14** Resistor decade  
**21** BCD, 10 position  
**23** Complement of BCD, 10 position  
**27** BCD, 10 position  
**31** BCD, 10 position  
**71** BCH, 16 position

**Mounting Style**

**00** Snap-in, front mount  
**09** Snap-in, front mount\*  
**10** Rear mount  
**19** Rear mount\*  
**20** Rear mount  
**29** Rear mount\*

**Terminations**

**0** Type 0  
**1** Type 1, extended type 0  
**N** Solder pins with .100" spacing\*\*  
**P** Solder pins with .156" spacing\*\*  
**9** Any combination

**Color/Marking/Stops**

**0** Matte black body, gloss black wheel, white marking

**Seal**

**0** No seal  
**1** Sealed contacts  
**2** Dust lens  
**3** Sealed contacts & dust lens

\*X9 mounting styles must be ordered with '0' number of sections.

\*\* Note: Termination option N (RoHS compliant) replaced termination option 3 (Non-RoHS compliant). Termination option P (RoHS compliant) replaced termination option B (Non-RoHS compliant).

# C&K 3 Series Thumbwheel Switches

## SERIES

### 3 THUMBWHEEL SWITCHES

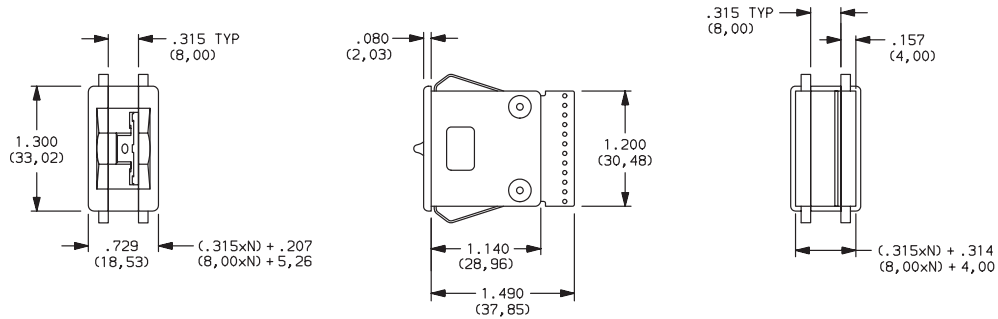

## NUMBER OF SECTIONS

- 0** Switch section only, no assembly. Blank bodies are considered sections; endplates are not sections. Must be ordered with 09 or 19 mounting style options, see pages N-10 and N-11.
- 1-8** Number of switch sections in assembly, includes endplates.
- 9** More than 8 switch sections, specify on CONFIGURATION FORM, page N-15 and consult Customer Service Center.

**NOTE:** Endplates and blank sections available separately, see pages N-13 and N-14.

## FUNCTION CODE

- 11** DECIMAL-1 POLE; 10 POSITION
- 14** RESISTOR DECADE; 1-2-2-2-2 CODE (RESISTORS NOT SUPPLIED)
- 21** BCD 1-2-4-8; 10 POSITION

W H E E L	SIGNALS CONNECTED TO COMMON SIGNAL C										C
	0	1	2	3	4	5	6	7	8	9	
0	●										●
1		●									●
2			●								●
3				●							●
4					●						●
5						●					●
6							●				●
7								●			●
8									●		●
9										●	●
	2	3	4	5	6	7	8	9	10	11	12
	TERM. LOCATION										

Available Terminations: 0, 1, N  
See fig. 1, page N-12.

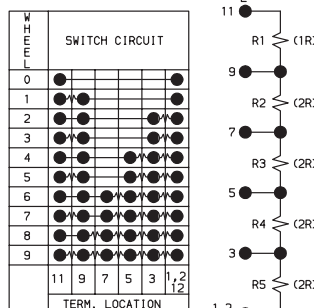

Available Terminations: 1  
See fig. 1, page N-12.

W H E E L	SIGNALS CONN. TO COMM. SIG. C				C
	1	2	4	8	
0					●
1	●				●
2		●			●
3			●		●
4				●	●
5	●				●
6	●	●			●
7	●	●	●		●
8	●	●	●	●	●
9	●				●
	3	5	7	11	9
	TERM. LOCATION				

Available Terminations: 0, 1, N  
See fig. 1, page N-12.

**NOTE:** For terminal location diagram, see page N-12.

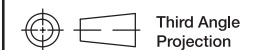

Dimensions are shown: Inch (mm)  
Specifications and dimensions subject to change



# C&K 3 Series Thumbwheel Switches

## FUNCTION CODE

**23** COMPLEMENT OF BCD 1-2-4-8;  
10 POSITION

W H E E L	SIGNALS CONN. TO COMM. SIG. C			
	1	2	4	8
0	●	●	●	●
1	●	●	●	●
2	●	●	●	●
3	●	●	●	●
4	●	●	●	●
5	●	●	●	●
6	●	●	●	●
7	●	●	●	●
8	●	●	●	●
9	●	●	●	●
	3	9	11	5
	TERM. LOCATION			

Available Terminations: 0, 1, N  
See fig. 1, page N-12.

**27** BCD 1-2-4-8; 10 POSITION

W H E E L	SIGNALS CONN. TO COMM. SIG. C			
	1	2	4	8
0	●	●	●	●
1	●	●	●	●
2	●	●	●	●
3	●	●	●	●
4	●	●	●	●
5	●	●	●	●
6	●	●	●	●
7	●	●	●	●
8	●	●	●	●
9	●	●	●	●
	4	5	1	2
	TERM. LOCATION			

Available Terminations: P  
See fig. 2, page N-12.

**31** BCD 1-2-4-8; 10 POSITION

W H E E L	SIGNALS CONN. TO COMM. SIG. C			
	1	2	4	8
0	●	●	●	●
1	●	●	●	●
2	●	●	●	●
3	●	●	●	●
4	●	●	●	●
5	●	●	●	●
6	●	●	●	●
7	●	●	●	●
8	●	●	●	●
9	●	●	●	●
	2	3	11	9
	TERM. LOCATION			

Available Terminations: 0, 1, N  
See fig. 1, page N-12.

**71** BINARY CODED HEXADECIMAL,  
16 POSITION

W H E E L	SIGNALS CONN. TO COMM. SIG. C			
	1	2	4	8
0	●	●	●	●
1	●	●	●	●
2	●	●	●	●
3	●	●	●	●
4	●	●	●	●
5	●	●	●	●
6	●	●	●	●
7	●	●	●	●
8	●	●	●	●
9	●	●	●	●
A	●	●	●	●
B	●	●	●	●
C	●	●	●	●
D	●	●	●	●
E	●	●	●	●
F	●	●	●	●
	3	5	7	11
	TERM. LOCATION			

Available Terminations: 0, 1, N  
See fig. 1, page N-12.

**NOTE:** For terminal location diagram, see page N-12.

## MOUNTING STYLE

### Type 0 Snap-In Front Mount

Thumbwheel & Pushwheel

MOUNTING STYLE	DIM. 'A'
00	$(.315 \times N) + .326$ $(8.00 \times N) + (8.28)$

N = Number of sections.

Recommended panel thickness:  
0.46-.125  
(1.16-3.18)

#### PANEL MOUNTING

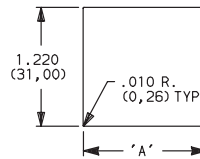

**00** SWITCH ASSEMBLY W/ ENDPLATES--.315 (8,00) SECTION PITCH

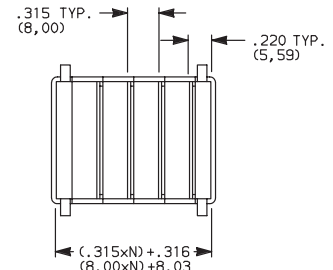
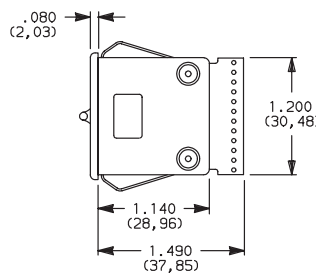
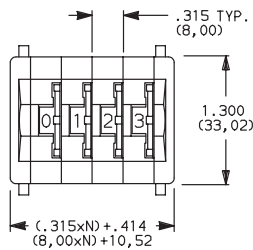

N = Number of sections.

**09** SWITCH SECTION ONLY--UNASSEMBLED WITHOUT ENDPLATES OR SPACERS  
(Must be ordered with number of sections option "0", see Page N-9.)

**NOTE:** Endplates, blank sections, spacers  
and assembly hardware available separately, see pages N-13 and N-14.

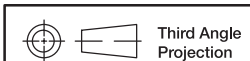

Dimensions are shown: Inch (mm)  
Specifications and dimensions subject to change



# C&K 3 Series Thumbwheel Switches

## MOUNTING STYLE

### Type 1 Rear Mount

MOUNTING STYLE	DIM. 'A'	DIM. 'B'
10	$(.350 \times N) + .340$ (8,89 x N) + (8,64)	$(.350 \times N) + .560$ (8,89 x N) + (14,22)

N = Number of sections.

Recommended panel thickness:  
0.46-.125  
(1,16-3,18)

### PANEL MOUNTING

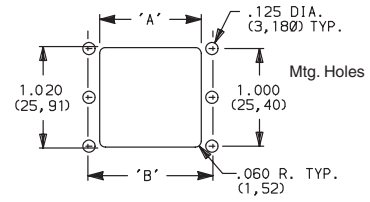

### 10 SWITCH ASSEMBLY W/ ENDPLATES--.350 (8,89) SECTION PITCH

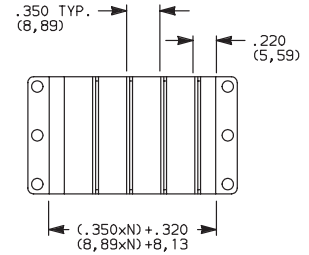
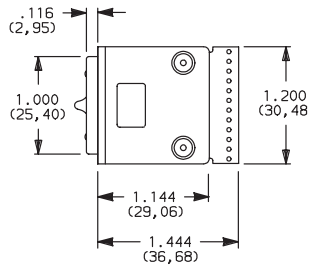
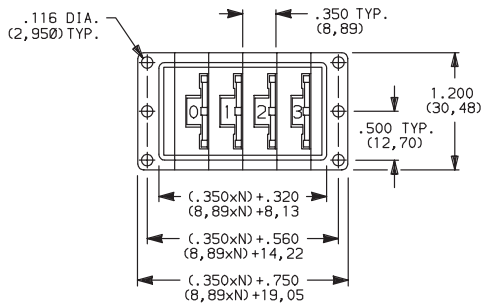

N = Number of sections.

### 19 SWITCH SECTION ONLY--UNASSEMBLED WITHOUT ENDPLATES OR SPACERS (Must be ordered with number of sections option "0", see Page N-9.)

### Type 2 Rear Mount

### 20 SWITCH ASSEMBLY W/ ENDPLATES--.350 (8,89) SECTION PITCH

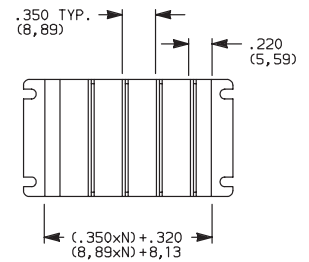
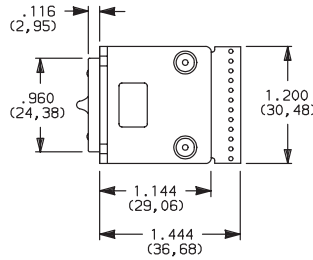
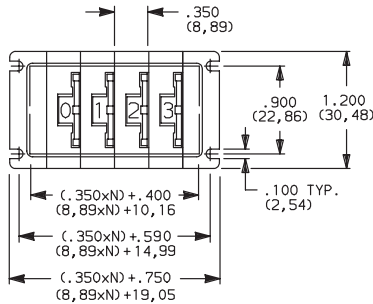

N = Number of sections.

### 29 SWITCH SECTION ONLY--UNASSEMBLED WITHOUT ENDPLATES OR SPACERS (Must be ordered with number of sections option "0", see Page N-9.)

Thumbwheel & Pushwheel



N

**NOTE:** Endplates, blank sections, spacers and assembly hardware available separately, see pages N-13 and N-14.

# C&K 3 Series Thumbwheel Switches

## TERMINATIONS

### 0 TYPE 0

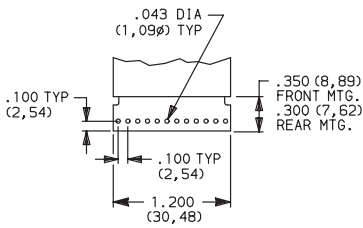

### 1 TYPE 1, EXTENDED TYPE 0

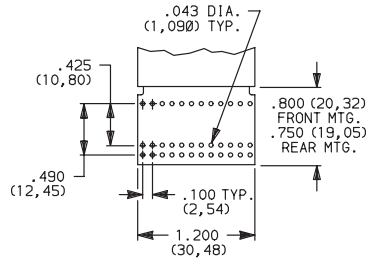

Signal traces cut except for common(s).

### N SOLDER PINS WITH .100" SPACING

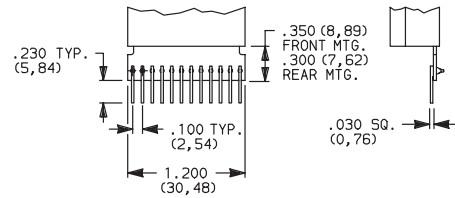

### 9 ANY COMBINATION OF TERMINATION CONFIGURATIONS OR SPECIAL TERMINATIONS.

Specify on configuration form, page N-15 and consult Customer Service Center.

### P SOLDER PINS WITH .156" SPACING

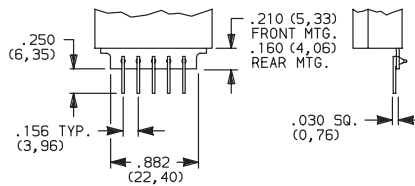

PC Board 1/32" (0,79) thick.

**NOTE:** All terminal holes shown may not be present for all function codes, consult Customer Service Center. Terminal connector available for termination options 0 & 1, see page N-14.

**NOTE:** Termination option N (RoHS compliant) replaced termination option 3 (Non-RoHS compliant). Termination option P (RoHS compliant) replaced termination option B (Non-RoHS compliant).

## Terminal Location Numbers

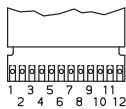

FIG. 1

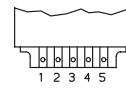

FIG. 2

**NOTE:** See function codes, pages N-9 and N-10, for signal locations.

## COLOR/MARKING/STOPS

### 0 MATTE BLACK HOUSING (Gloss black wheel with white characters; no stops.)

**NOTE:** Stop pins are available separately, see page N-14.

## SEAL

### 0 UNSEALED SWITCHING CONTACTS.

**1 SEALED SWITCHING CONTACTS.** (Sealing is by means of an o-ring rotary seal and a cured-in-place elastomer gasket. Switching contact area is protected from moisture, oil, and airborne contaminants.)

**2 DUST LENS.** (Protects the character face of the wheel from abrasion and dirt.)

**3 SEALED SWITCHING CONTACTS AND DUST LENS**

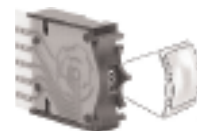

Dust Lens



Third Angle Projection

Dimensions are shown: Inch (mm)  
Specifications and dimensions subject to change



# C&K 3 Series Thumbwheel Switches

## AVAILABLE HARDWARE

Blank sections, Type 0,  
.315 THK.



**PART NO.**  
**413602000** W/RIB-BLACK  
**400502000** W/RIB & W/OUT SPRINGS-BLACK

Blank sections, Front mount, Type 0,  
.315 THK.



**PART NO.**  
**413502000** PLAIN-BLACK  
**400702000** PLAIN & W/OUT SPRINGS-BLACK

Blank sections, Rear mount, Type 1,  
.350 THK.



4006 4008

**PART NO.**  
**400602000** W/RIB-BLACK  
**400802000** PLAIN-BLACK

Blank sections, Rear mount, Type 2,  
.350 THK.



4734 4733

**PART NO.**  
**473402000** W/RIB-BLACK  
**473302000** PLAIN-BLACK

End plates, Front mount, Type 0



**PART NO.**  
**413402000** BLACK  
Two required for complete assembly.

End plates, Rear mount, Type 1



**PART NO.**  
**400402000** BLACK  
Two required for complete assembly.

End plates, Rear mount, Type 2



**PART NO.**  
**473202000** BLACK  
Two required for complete assembly.

Spacers, Front mount, Type 0 & 3, .078 THK.  
(Makes section pitch 10mm)



**PART NO.**  
**410802000** BLACK

Stop pins



**PART NO.**  
**402900000**

Thumbwheel & Pushwheel



N

# C&K 3 Series Thumbwheel Switches

## AVAILABLE HARDWARE

Terminal connector

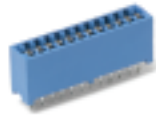

605A00000

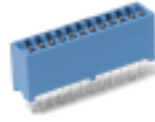

605A02000

**PART NO.**

**605A00000** PC

**605A02000** SOLDER LUG

Fits 0 & 1 terminations only.

Screws for field assembly of thumbwheel switches  
(2 screws needed per assembly + 403500000 nuts)

SCREW PART NUMBER (0-80 UNF THD. SIZE)	NUMBER OF SECTIONS IN ASSEMBLY	
	FRONT MOUNTING	REAR MOUNTING
	MTG. STYLE - 00	MTG. STYLE - 10
<b>412700000</b>	1-2	1-2
<b>412701000</b>	3-4	3
<b>412702000</b>	5-7	4-6

Thumbwheel & Pushwheel

Nut



Two nuts required per assembly and screws.

**PART NO.**

**403500000**

Nut driver (For 403500000 nut)



**PART NO.**

**406100652**



N

# C&K 3 Series Thumbwheel Switches

## Configuration Form

GRAY SHADED AREAS TO BE FILLED IN BY CUSTOMER SERVICE.

CATALOG PART NO.

**3**

C&K PART NUMBER

C&K PART NUMBER

COMPANY NAME \_\_\_\_\_











CUSTOMER PRINT REVISION:

ADDRESS \_\_\_\_\_ TEL.# \_\_\_\_\_

CUSTOMER CONTACT \_\_\_\_\_ DATE \_\_\_\_\_

DETAILS:

ORIGINATED BY \_\_\_\_\_ SALES REP. \_\_\_\_\_

THUMBWHEEL SECTIONS	NO. OF SEC.	FUNCTION CODE – TERMINATIONS – COLOR/MARKING/STOPS/SEAL – ILLUMINATION <small>ENTER OPTION CODES IN APPROPRIATE BOXES. FUNCTION CODES INCLUDE BLANK SECTIONS (SEE PAGES M-9 &amp; M-10).</small>	DESCRIBE IN APPROPRIATE ROW
	<b>1</b>	3 - <input type="text"/> <input type="text"/> - - <input type="text"/> <input type="text"/> <input type="text"/> <input type="text"/>	
	<b>2</b>	3 - <input type="text"/> <input type="text"/> - - <input type="text"/> <input type="text"/> <input type="text"/> <input type="text"/>	
	<b>3</b>	3 - <input type="text"/> <input type="text"/> - - <input type="text"/> <input type="text"/> <input type="text"/> <input type="text"/>	
	<b>4</b>	3 - <input type="text"/> <input type="text"/> - - <input type="text"/> <input type="text"/> <input type="text"/> <input type="text"/>	
	<b>5</b>	3 - <input type="text"/> <input type="text"/> - - <input type="text"/> <input type="text"/> <input type="text"/> <input type="text"/>	
	<b>6</b>	3 - <input type="text"/> <input type="text"/> - - <input type="text"/> <input type="text"/> <input type="text"/> <input type="text"/>	
	<b>7</b>	3 - <input type="text"/> <input type="text"/> - - <input type="text"/> <input type="text"/> <input type="text"/> <input type="text"/>	
	<b>8</b>	3 - <input type="text"/> <input type="text"/> - - <input type="text"/> <input type="text"/> <input type="text"/> <input type="text"/>	
	<b>9</b>	3 - <input type="text"/> <input type="text"/> - - <input type="text"/> <input type="text"/> <input type="text"/> <input type="text"/>	
	<b>10</b>	3 - <input type="text"/> <input type="text"/> - - <input type="text"/> <input type="text"/> <input type="text"/> <input type="text"/>	
	<b>11</b>	3 - <input type="text"/> <input type="text"/> - - <input type="text"/> <input type="text"/> <input type="text"/> <input type="text"/>	

QUALITY CONTROL INSTRUCTIONS

PRODUCTION APPROVAL      DATE

Q.C. APPROVAL      DATE

REV.      INITIALS      DATE

FOR SWITCHES WITH MORE THAN 11 SECTIONS, CONTINUE ON ADDITIONAL SHEETS.

SPECIAL INSTRUCTIONS OR SPECIFICATIONS:

SHEET \_\_\_\_ OF \_\_\_\_



Dimensions are shown: Inch (mm)  
Specifications and dimensions subject to change

Thumbwheel & Pushwheel

