

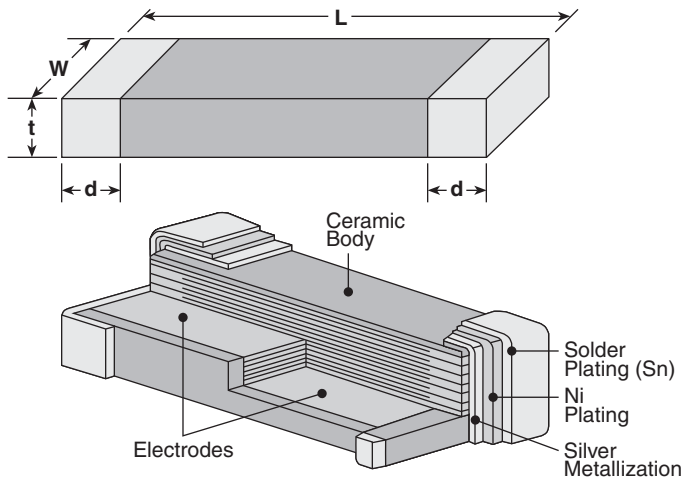

features

- High Q factor
- Low T.C.C.
- Available in high capacitance values (up to 100 μ F)
- Products with lead-free terminations meet EU RoHS requirements

dimensions and construction



Case Size	Dimensions inches (mm)			
	L	W	t (Max.)	d
0402	.039 \pm .004 (1.0 \pm 0.1)	.02 \pm .004 (0.5 \pm 0.1)	.021 (0.55)	.01 \pm .006 (0.25 \pm 0.15)
0603	.063 \pm .006 (1.6 \pm 0.15)	.032 \pm .006 (0.81 \pm 0.15)	.035 (0.9)	.014 \pm .006 (0.35 \pm 0.15)
0805	.079 \pm .008 (2.01 \pm 0.2)	.049 \pm .008 (1.25 \pm 0.2)	.051 (1.3)	.02 \pm .01 (0.50 \pm 0.25)
1206	.126 \pm .008 (3.2 \pm 0.2)	.063 \pm .008 (1.6 \pm 0.2)	.059 (1.5)	.02 \pm .01 (0.5 \pm 0.25)
1210	.126 \pm .008 (3.2 \pm 0.2)	.098 \pm .008 (2.5 \pm 0.2)	.067 (1.7)	.02 \pm .01 (0.5 \pm 0.25)

capacitors

ordering information

New Part #	NPO	0805	H	T	TD	101	K
	Dielectric	Size	Voltage	Termination Material	Packaging	Capacitance	Tolerance
	NPO X5R X7R Y5V	0402 0603 0805 1206 1210	A = 10V C = 16V E = 25V H = 50V I = 100V J = 200V K = 6.3V	T: Sn	TP: 7" 2mm pitch (0402 only) TD: 7" paper tape TE: 7" embossed plastic TDB: 13" paper tape TEB: 13" embossed plastic	NPO, X5R, X7R, Y5V: 2 significant digits + no. of zeros. "R" indicates decimal point	B: \pm 0.1pF C: \pm 0.25pF D: \pm 0.5pF F: \pm 1% G: \pm 2% J: \pm 5% K: \pm 10% M: \pm 20% Z: +80, -20%

For further information on packaging, please refer to Appendix B.

applications and ratings

Dielectric	Capacitance Range	Capacitance Tolerance*	Voltage Ratings	Dissipation Factor	T.C.C.	Test Voltage	Operating Temperature	Insulation Resistance
NPO	0.47pF - 1000μF	.47pF~8.2pF= C:±0.25pF 5.6pF~8.2pF= D±0.5pF 10pF~ 10000pF= F:±1%, G:±2%,J:±5%	50V 100V 200V	For Values >30pF: 0.1% max., ≤30pF: Q = 400 + 20 x C DF = 1/Q C is in pF	0 ± 30 ppm/°C	1.0 ± 0.2 Vrms	-55°C to +125°C	+25°C 100,000MΩ min. or 1000 MΩ - μF min. whichever is less
X5R	0.068μF - 100μF	K: ±10%	6.3V 10V	6.3V = 7.5% max. 10V = 10% max.	±15% (0 VDC)	1.0 ± 0.2 Vrms	-55°C to +85°C	+25°C 100,000MΩ min. or 500 MΩ - μF min. whichever is less
X7R	100pF - 4.7μF	K: ±10%	10V 16V 25V 50V 100V 200V	10V = 10% max. 16V = 3.5% max. 25V, 50V, 100V = 2.5% max.	±15% (0 VDC)	1.0 ± 0.2 Vrms	-55°C to +125°C	+25°C 100,000MΩ min. or 1000 MΩ - μF min. whichever is less
Y5V	10000pF - 22μF	Z: +80, -20%	10V 16V 25V 50V	16V & 25V = 7.0% 50V = 5.0%	+22% to -82% max.	1.0 ± 0.2 Vrms	-30°C to +85°C	+25°C 10,000MΩ min. or 1000 MΩ - μF min. whichever is less

* Special tolerances available, please consult factory.

For complete environmental specifications, please refer to www.koaspeer.com

X5R capacitance voltage availability

Size			0402	0603		0805	1206	1210
Capacitance values pF	μF		10 (A)	6.3 (K)	10 (A)	6.3 (K)	10 (A)	10 (A)
56000	0.056	563						
68000	0.068	683						
82000	0.082	823						
100000	0.10	104						
120000	0.12	124						
150000	0.15	154						
180000	0.18	184						
220000	0.22	224						
270000	0.27	274						
330000	0.33	334						
470000	0.47	474						
560000	0.56	564						
680000	0.68	684						
820000	0.82	824						
1000000	1.0	105						
1200000	1.2	125						
1500000	1.5	155						
1800000	1.8	185						
2200000	2.2	225						
3300000	3.3	335						
4700000	4.7	475						
6800000	6.8	685						
10000000	10	106						
22000000	22	226						
47000000	47	476						
100000000	100	107						

Capacitance tolerance available: ±10%

Specifications given herein may be changed at any time without prior notice. Please confirm technical specifications before you order and/or use.

1/05/11

NPO capacitance voltage availability

Size				0402*	0603*		0805			1206		
pF	Capacitance values µF	Cap. Code	WVDC	50 (H)	50 (H)	100 (I)	50 (H)	100 (I)	200 (J)	50 (H)	100 (I)	200 (J)
0.47	.0000047	R47										
0.56	.0000056	R56										
0.68	.0000068	R68										
0.82	.0000082	R82										
1	.0000010	1R0										
1.2	.0000012	1R2										
1.5	.0000015	1R5										
1.8	.0000018	1R8										
2.2	.0000022	2R2										
2.7	.0000027	2R7										
3.3	.0000033	3R3										
3.9	.0000039	3R9										
4.7	.0000047	4R7										
5.6	.0000056	5R6										
6.8	.0000068	6R8										
8.2	.0000082	8R2										
10	.000010	100										
12	.000012	120										
15	.000015	150										
18	.000018	180										
22	.000022	220										
27	.000027	270										
33	.000033	330										
39	.000039	390										
47	.000047	470										
56	.000056	560										
68	.000068	680										
82	.000082	820										
100	.0001	101										
120	.00012	121										
150	.00015	151										
180	.00018	181										
220	.00022	221										
270	.00027	271										
330	.00033	331										
390	.00039	391										
470	.00047	471										
560	.00056	561										
680	.00068	681										
820	.00082	821										
1000	.0010	102										
1200	.0012	122										

Capacitance tolerance available:

.47pF~8.2pF = C: ±0.25pF

5.6pF~8.2pF = D: ±0.5pF

10pF~10000pF = F: ±1%, G: ±2%, J: ±5%

X7R capacitance voltage availability

Size			0402				0603				0805				1206					1210					
Capacitance pF	values μF	Cap. Code	10	16	25	50	10	16	25	50	10	16	25	50	100	200	10	16	50	100	200	50	100	200	
			(A)	(C)	(E)	(H)	(A)	(C)	(E)	(H)	(A)	(C)	(E)	(H)	(I)	(J)	(A)	(C)	(H)	(I)	(J)	(H)	(I)	(J)	
100	.0001	101																							
120	.00012	121																							
150	.00015	151																							
180	.00018	181																							
220	.00022	221																							
270	.00027	271																							
330	.00033	331																							
390	.00039	391																							
470	.00047	471																							
560	.00056	561																							
680	.00068	681																							
820	.00082	821																							
1000	.0010	102																							
1200	.0012	122																							
1500	.0015	152																							
1800	.0018	182																							
2200	.0022	222																							
2700	.0027	272																							
3300	.0033	332																							
3900	.0039	392																							
4700	.0047	472																							
5600	.0056	562																							
6800	.0068	682																							
8200	.0082	822																							
10000	.010	103																							
12000	.012	123																							
15000	.015	153																							
18000	.018	183																							
22000	.022	223																							
27000	.027	273																							
33000	.033	333																							
39000	.039	393																							
47000	.047	473																							
56000	.056	563																							
68000	.068	683																							
82000	.082	823																							
100000	.100	104																							
120000	.120	124																							
150000	.150	154																							
180000	.180	184																							
220000	.220	224																							
270000	.270	274																							
330000	.330	334																							
390000	.390	394																							
470000	.470	474																							
560000	.560	564																							
680000	.680	684																							
1000000	1.00	105																							
1200000	1.20	125																							
1500000	1.50	155																							
1800000	1.80	185																							
2200000	2.20	225																							
3900000	3.90	395																							
4700000	4.70	475																							

Capacitance tolerance available: ±10%

Y5V capacitance voltage availability

Size			0402	0603			0805				1206			
Capacitance values pF	μF	Cap. Code	16	16	25	50	10	16	25	50	10	16	25	50
			(C)	(C)	(E)	(H)	(A)	(C)	(E)	(H)	(A)	(C)	(E)	(H)
2200	.0022	222												
2700	.0027	272												
3300	.0033	332												
3900	.0039	392												
4700	.0047	472												
5600	.0056	562												
6800	.0068	682												
8200	.0082	822												
10000	.010	103												
12000	.012	123												
15000	.015	153												
18000	.018	183												
22000	.022	223												
27000	.027	273												
33000	.033	333												
39000	.039	393												
47000	.047	473												
56000	.056	563												
68000	.068	683												
82000	.082	823												
100000	.100	104												
120000	.120	124												
150000	.150	154												
180000	.180	184												
220000	.220	224												
270000	.270	274												
330000	.330	334												
390000	.390	394												
470000	.470	474												
560000	.560	564												
680000	.680	684												
820000	.820	824												
1000000	1.0	105												
1200000	1.2	125												
1500000	1.5	155												
1800000	1.8	185												
2200000	2.2	225												
2700000	2.7	275												
3300000	3.3	335												
3900000	3.9	395												
4700000	4.7	475												
5600000	5.6	565												
6800000	6.8	685												
10000000	10	106												
22000000	22	226												

Capacitance tolerance available: +80%, -20%

capacitors