

Ceramic Chip Capacitors

Type NPO, X5R, X7R, Y5V

ISO 9001:2000
TS-16949

1. General

1-1 Range of Application

This document applies to miniaturized ceramic chip capacitors for applications in circuits of electronic devices.

2. Type Designation

The type designation shall be the following form:

New Type

NPO	0805	H	T	TD	101	K
Dielectric	Size	Voltage	Termination Material	Packaging	Capacitance Code	Tolerance
NPO X5R X7R Y5V	0402 0603 0805 1206 1210	A = 10V C = 16V E = 25V H = 50V I = 100V J = 200V K = 6.3V	T: Sn	TP: 7" 2mm pitch (0402 only) TD: 7" paper tape TE: 7" embossed plastic TDB: 13" paper tape TEB: 13" embossed plastic	NPO, X5R, X7R, Y5V - 2 significant digits + no. of zeros. R indicates decimal point.	B = ±0.1pF C = ±0.25pF D = ±0.5pF F = ±1% G = ±2% J = ±5% K = ±10% M = ±20% Z = +80%, -20%

3. Dimensions and Construction

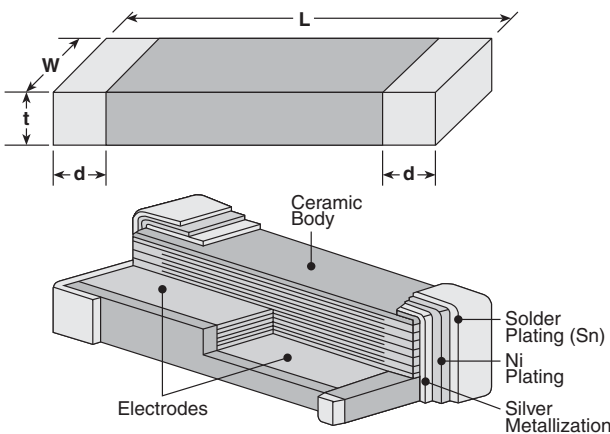

Table 1

Dimensions in inches (mm)

Case Code	L	W	t (Max.)	d
0402	.040 ± .004 (1.00 ± .10)	.020 ± .004 (.50 ± .10)	.021 (.55)	.010 ± .006 (.25 ± .15)
0603	.063 ± .006 (1.60 ± .15)	.032 ± .006 (.81 ± .15)	.035 (.90)	.014 ± .006 (.35 ± .15)
0805	.079 ± .008 (2.01 ± .20)	.049 ± .008 (1.25 ± .20)	.051 (1.30)	.020 ± .010 (.50 ± .25)
1206	.126 ± .008 (3.20 ± .20)	.063 ± .008 (1.60 ± .20)	.059 (1.50)	.020 ± .010 (.50 ± .25)
1210	.126 ± .008 (3.20 ± .20)	.098 ± .008 (2.50 ± .20)	.067 (1.70)	.020 ± .010 (.50 ± .25)

4. Terminations

- Standard Nickel Barrier
- Solder Plated

5. Applications and Ratings

Dielectric	Capacitance Range	Capacitance Tolerance*	Voltage Ratings	Dissipation Factor	T.C.C.	Test Voltage	Operating Temperature	Insulation Resistance
NPO	0.47pF - 0.039μF	.47pF~8.2pF= C:±0.25pF 5.6pF~8.2pF= D±0.5pF 10pF~10000pF= F:±1%, G:±2%, J:±5%	16V 25V 50V 100V 200V	For Values >30pF: 0.1% max., ≤30pF: Q = 400 + 20 x C DF = 1/Q C is in pF	0 ± 30 ppm/°C	1.0 ± 0.2 Vrms	-55°C to +125°C	+25°C 100,000MΩ min. or 1000 MΩ - μF min. whichever is less
X5R	0.068μF - 10μF	K: ±10%	6.3V 10V	6.3 = 7.3% 10 = 5.0%	±15% (0 VDC)	1.0 ± 0.2 Vrms	-55°C to +85°C	+25°C 100,000MΩ min. or 500 MΩ - μF min. whichever is less
X7R	100pF - 4.7μF	K: ±10%	10V 16V 25V 50V 100V 200V	For 50 & 100 volts 2.5% max. 25 = 3.0% 16 = 3.5%	±15% (0 VDC)	1.0 ± 0.2 Vrms	-55°C to +125°C	+25°C 100,000MΩ min. or 1000 MΩ - μF min. whichever is less
Y5V	2200pF - 10μF	Z: +80, -20%	10V 16V 25V 50V	16V & 25V = 7.0% 50V = 5.0%	+22% to -82% max.	1.0 ± 0.2 Vrms	-30°C to +85°C	+25°C 10,000MΩ min. or 1000 MΩ - μF min. whichever is less

* Special tolerances available, please consult factory.

6. NPO Capacitance Voltage Availability

Size		0402*			0603*		0805			1206			1210		
Capacitance values pF	Cap. Code	WVDC	16 (C)	25 (E)	50 (H)	50 (H)	100 (I)	50 (H)	100 (I)	200 (J)	50 (H)	100 (I)	200 (J)	50 (H)	200 (J)
0.47	R47														
0.56	R56														
0.68	R68														
0.82	R82														
1	1R0														
1.2	1R2														
1.5	1R5														
1.8	1R8														
2.2	2R2														
2.7	2R7														
3.3	3R3														
3.9	3R9														
4.7	4R7														
5.6	5R6														
6.8	6R8														
8.2	8R2														
10	100														
12	120														
15	150														
18	180														
22	220														
27	270														
33	330														
39	390														
47	470														
56	560														
68	680														
82	820														
100	.0001 101														
120	.00012 121														
150	.00015 151														
180	.00018 181														
220	.00022 221														
270	.00027 271														
330	.00033 331														
390	.00039 391														
470	.00047 471														
560	.00056 561														
680	.00068 681														
820	.00082 821														
1000	.0010 102														
1200	.0012 122														
1500	.0015 152														
1800	.0018 182														
2200	.0022 222														
2700	.0027 272														
3300	.0033 332														
3900	.0039 392														
4700	.0047 472														
5600	.0056 562														
6800	.0068 682														
8200	.0082 822														
10000	.010 103														
12000	.012 123														
15000	.015 153														
18000	.018 183														
22000	.022 223														
27000	.027 273														
33000	.033 333														
39000	.039 393														

* IR and vapor phase solder only recommended

Capacitance tolerance available: .47pF~8.2pF = C: ±0.25pF, 5.6pF~8.2pF = D: ±0.5pF
 10pF~10000pF = F: ±1%, G: ±2%, J: ±5%

7. X5R Capacitance Voltage Availability

Size	0402			0603				0805				1206				1210	
	6.3 (K)	10 (A)	16 (C)	6.3 (K)	10 (A)	16 (C)	25 (E)	6.3 (K)	10 (A)	16 (C)	25 (E)	6.3 (K)	10 (A)	16 (C)	25 (E)	6.3 (K)	10 (A)
100																	
150																	
220																	
330																	
470																	
680																	
1000																	
1200																	
1500																	
1800																	
2200																	
2700																	
3300																	
3900																	
4700																	
5600																	
6800																	
8200																	
0.010																	
0.012																	
0.015																	
0.018																	
0.022																	
0.027																	
0.033																	
0.039																	
0.047																	
0.056		■															
0.068		■															
0.082		■															
0.10		■															
0.12		■															
0.15		■															
0.18																	
0.22																	
0.27																	
0.33					■												
0.47					■												
0.56					■												
0.68					■												
0.82					■												
1.0					■												
1.2																	
1.5																	
1.8																	
2.2									■								
3.3									■								
4.7									■				■				
6.8													■				
10													■				
22													■				
47																	■
100																	

Capacitance tolerance available: ±10%

8. X7R Capacitance Voltage Availability

Size			0402*				0603*				0805						1206						1210		
Capacitance values pF	μF	Cap. Code	10	16	25	50	10	16	25	50	10	16	25	50	100	200	10	16	25	50	100	200	50	100	200
			(A)	(C)	(E)	(H)	(A)	(C)	(E)	(H)	(A)	(C)	(E)	(H)	(I)	(J)	(A)	(C)	(E)	(H)	(I)	(J)	(H)	(I)	(J)
100	.0001	101																							
120	.00012	121																							
150	.00015	151																							
180	.00018	181																							
220	.00022	221																							
270	.00027	271																							
330	.00033	331																							
390	.00039	391																							
470	.00047	471																							
560	.00056	561																							
680	.00068	681																							
820	.00082	821																							
1000	.0010	102																							
1200	.0012	122																							
1500	.0015	152																							
1800	.0018	182																							
2200	.0022	222																							
2700	.0027	272																							
3300	.0033	332																							
3900	.0039	392																							
4700	.0047	472																							
5600	.0056	562																							
6800	.0068	682																							
8200	.0082	822																							
10000	.010	103																							
12000	.012	123																							
15000	.015	153																							
18000	.018	183																							
22000	.022	223																							
27000	.027	273																							
33000	.033	333																							
39000	.039	393																							
47000	.047	473																							
56000	.056	563																							
68000	.068	683																							
82000	.082	823																							
100000	.100	104																							
120000	.120	124																							
150000	.150	154																							
180000	.180	184																							
220000	.220	224																							
270000	.270	274																							
330000	.330	334																							
390000	.390	394																							
470000	.470	474																							
560000	.560	564																							
680000	.680	684																							
1000000	1.00	105																							
1200000	1.20	125																							
1500000	1.50	155																							
1800000	1.80	185																							
2200000	2.20	225																							
3900000	3.90	395																							
4700000	4.70	475																							

* IR and vapor phase solder only recommended

Capacitance tolerance available: ±10%

9. Y5V Capacitance Voltage Availability

Size			0402*		0603*				0805				1206			
Capacitance values pF	μF	Cap. Code	10 (A)	16 (C)	10 (A)	16 (C)	25 (E)	50 (H)	10 (A)	16 (C)	25 (E)	50 (H)	10 (A)	16 (C)	25 (E)	50 (H)
2200	.0022	222														
2700	.0027	272														
3300	.0033	332														
3900	.0039	392														
4700	.0047	472														
5600	.0056	562														
6800	.0068	682														
8200	.0082	822														
10000	.010	103														
12000	.012	123														
15000	.015	153														
18000	.018	183														
22000	.022	223														
27000	.027	273														
33000	.033	333														
39000	.039	393														
47000	.047	473														
56000	.056	563														
68000	.068	683														
82000	.082	823														
100000	.100	104														
120000	.120	124														
150000	.150	154														
180000	.180	184														
220000	.220	224														
270000	.270	274														
330000	.330	334														
390000	.390	394														
470000	.470	474														
560000	.560	564														
680000	.680	684														
820000	.820	824														
1000000	1.0	105														
1200000	1.2	125														
1500000	1.5	155														
1800000	1.8	185														
2200000	2.2	225														
2700000	2.7	275														
3300000	3.3	335														
3900000	3.9	395														
4700000	4.7	475														
5600000	5.6	565														
6800000	6.8	685														
10000000	10	106														
22000000	22	226														

* IR and vapor phase solder only recommended

Capacitance tolerance available: +80, -20%

10. Typical Impedance Characteristics - NPO

Variation of Impedance with Cap Value
Impedance vs. Frequency
0805 - C0G (NPO)
10 pF vs. 100 pF vs. 1000 pF

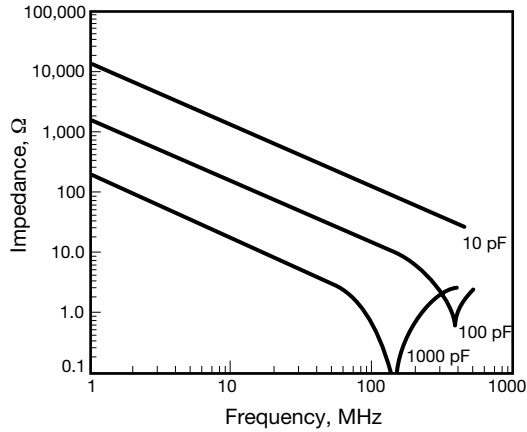

Δ Capacitance vs. Frequency

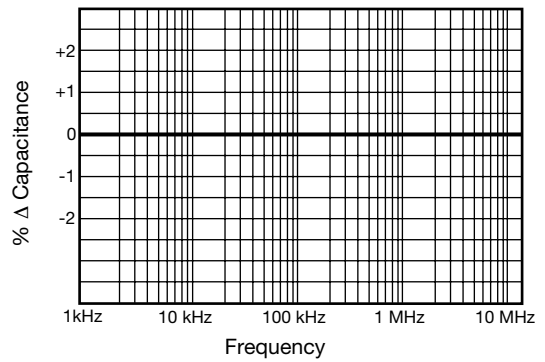

Temperature Coefficient

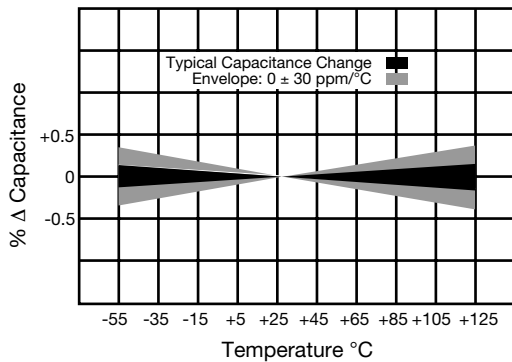

Insulation Resistance vs. Temperature

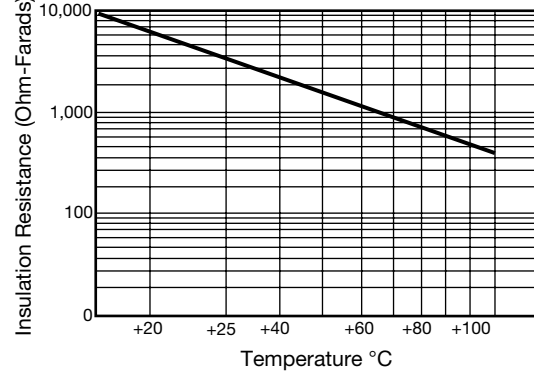

Variation of Impedance with Chip Size
Impedance vs. Frequency
1000 pF - C0G (NPO)

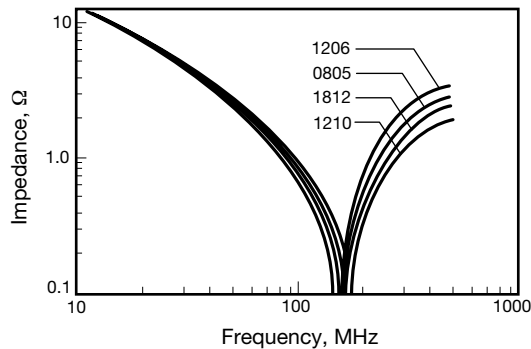

Variation of Impedance with Ceramic Formulation
Impedance vs. Frequency
1000 pF - C0G (NPO) vs X7R
0805

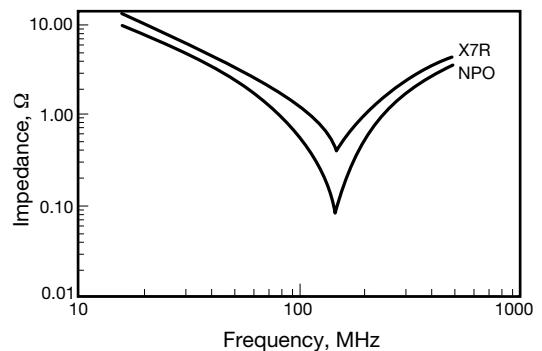

11. Typical Impedance Characteristics - X5R

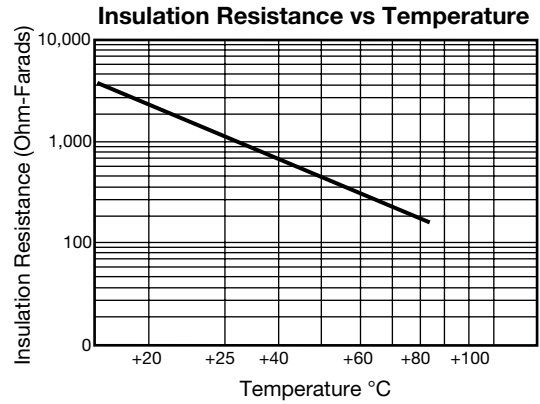
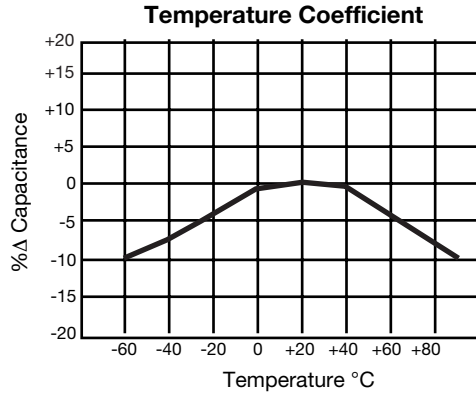

12. Typical Impedance Characteristics - X7R

**Variation of Impedance with Cap Value
Impedance vs. Frequency
1,000 pF vs. 10,000 pF - X7R
0805**

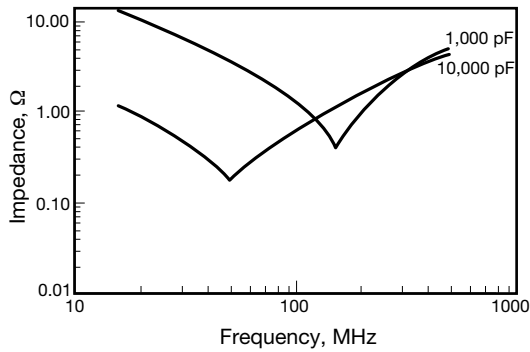

Δ Capacitance vs. Frequency

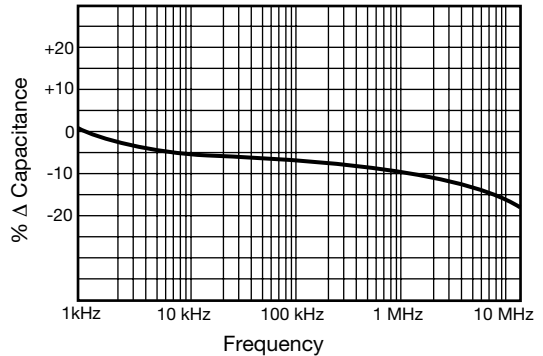

Temperature Coefficient

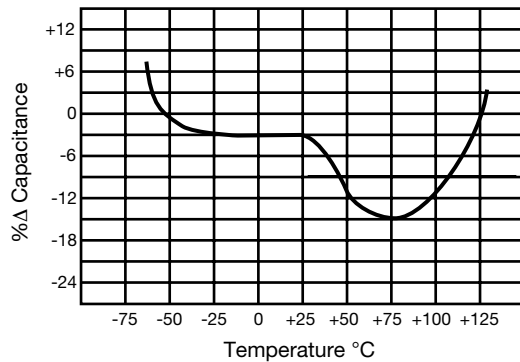

Insulation Resistance vs Temperature

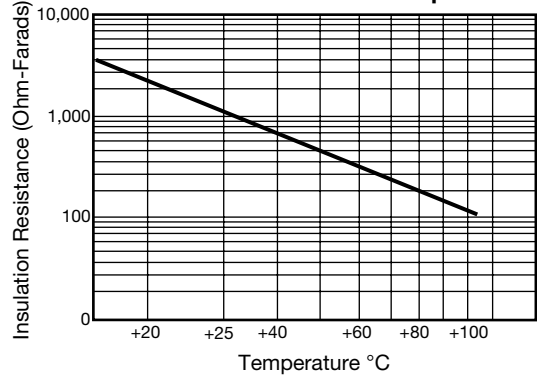

**Variation of Impedance with Chip Size
Impedance vs. Frequency
10,000 pF - X7R**

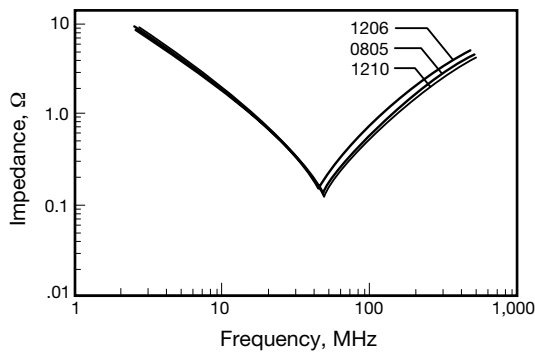

**Variation of Impedance with Chip Size
Impedance vs. Frequency
100,000 pF - X7R**

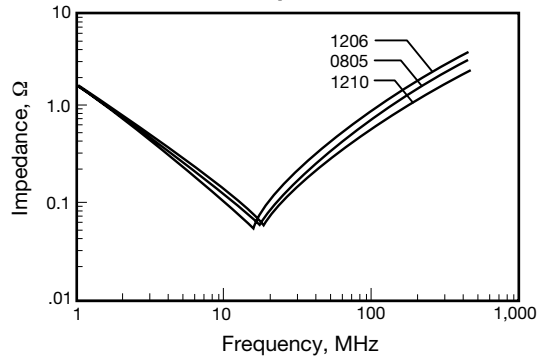

13. Typical Impedance Characteristics - Y5V

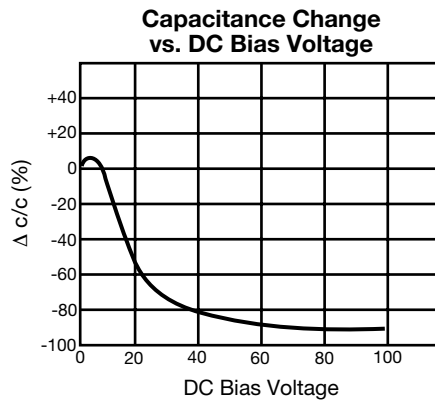
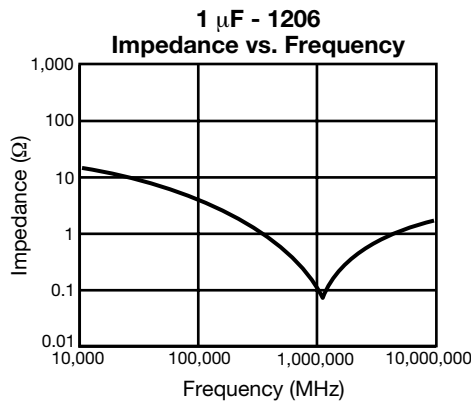
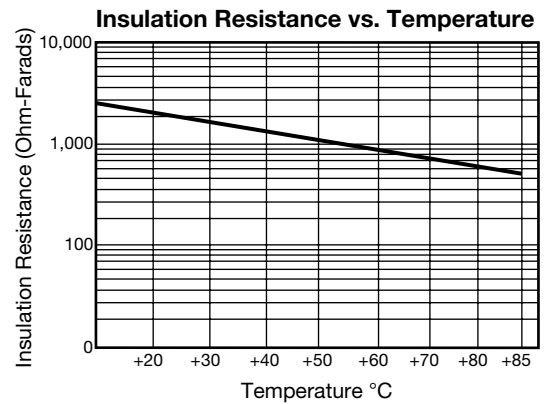
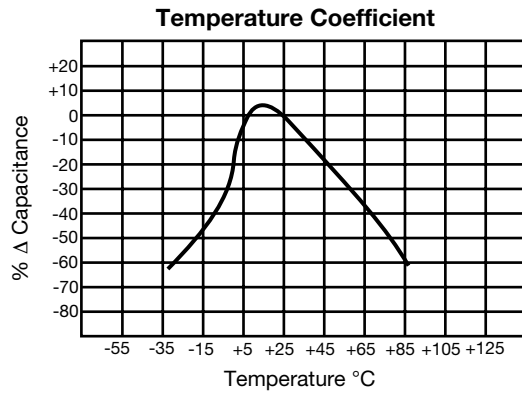
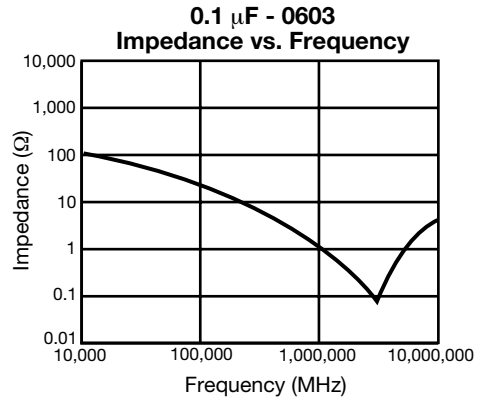
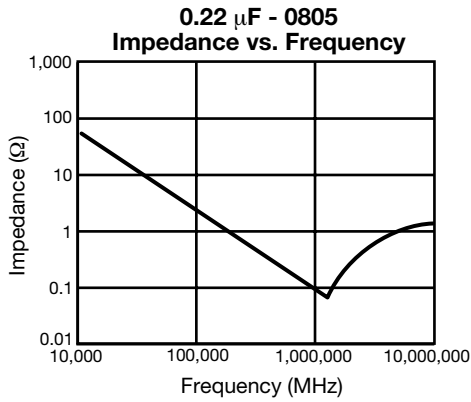

14. Tape and Reel Quantities

All tape and reel specifications are in compliance with RS481.

Dimensions in inches (mm)

	0402	0603	0805	1206	1210
TE = 7" (178) Plastic	N/A	N/A	*2,000/4,000	2,000	*2,000/4,000
B = 13" (330) Plastic	N/A	N/A	10,000	10,000	10,000
T = 7" (178) Paper	15,000	4,000	4,000	4,000	4,000
D = 13" (330) Paper	N/A	10,000	10,000	10,000	10,000

* Z5U 0805 50V \geq 104pf = 2k, 1206 50V \geq 184pf = 2k, 1210 50V \geq 274pf = 2k;
 Y5V 0805 50V \geq 124pf = 2k, 25V \geq 394pf = 2k, 16V \geq 474pf = 2k, 1206 25V \geq 564pf = 2k, 16V \geq 824pf = 2k, 1210 50V \geq 334pf = 2k, 25V \geq 105pf = 2k;
 X7R 0805 100V \geq 123pf = 2k, 50V \geq 101pf = 2k, 16V \geq 154pf = 2k, 1206 100V \geq 393pf = 2k, 25V \geq 124pf = 2k, 16V \geq 394pf = 2k;
 NPO 0805 100V \geq 391pf = 2k, 50V \geq 561pf = 2k, 1206 100V \geq 152pf = 2k, 50V \geq 152pf = 2k, 1210 100V \geq 182pf = 2k, 50V \geq 272pf = 2k
 0805 Y5VCTE 225 Z, 1206 Y5VCTE 335 Z, 1210 Y5VETE 475 Z = 3k

15. Reel Dimensions

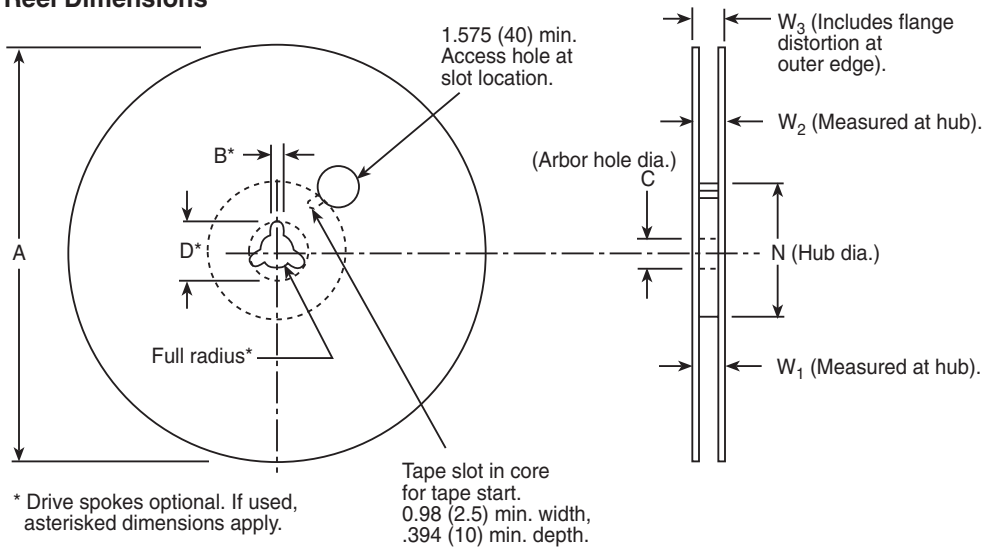

Dimensions in inches (mm)

Tape Size ⁽¹⁾	A Max.	B* Min.	C	D* Min.	N Min.	W ₁	W ₂ Max.	W ₃
8mm	7.0 (178)	.059 (1.5)	.512 ± .008 (13.0 ± 0.20)	.795 (20.2)	1.969 (50)	.331 ^{± .050} _{0.0} (8.4 ^{± 1.0} _{0.0})	.567 14.4	.311 (7.9 Min.) .429 (10.9 Max.)
12mm	12.992 (330)					.488 ^{± .078} _{0.0} (12.4 ^{± 2.0} _{0.0})	.724 (18.4)	.469 (11.9 Min.) .607 (15.4 Max.)

Metric dimensions will govern.

English measurements rounded and for reference only.

(1) For tape sizes 16mm and 24mm (used with chip size 3 3640) consult EIA RS-481 latest revision.

16. Carrier Tape Specifications

Embossed plastic
8 & 12mm

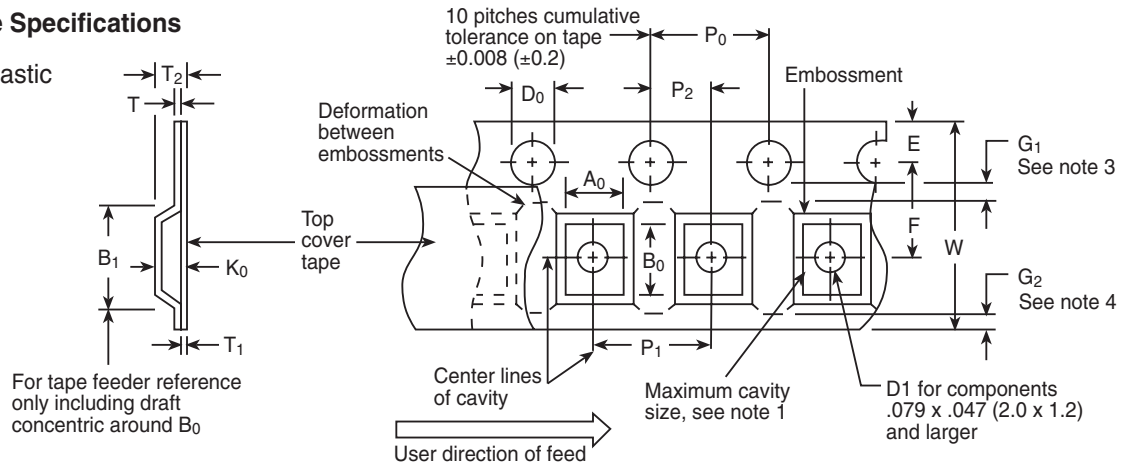

17. Dimensions

Dimensions in inches (mm)

Tape Size <i>Constant</i>	D ₀	E	P ₀	P ₂	T Max.	T ₁	G ₁	G ₂
8mm and 12mm	.059 ± .004 (1.5 ± 0.10)	.069 ± .004 (1.75 ± 0.10)	.157 ± .004 (4.0 ± 0.10)	.079 ± .002 (2.0 ± 0.05)	.024 (0.600)	.004 (0.10) Max.	.030 (0.75) Min. See note 3	.030 (0.75) Min. See note 4
Tape Size <i>Variable</i>	B ₁ Max. See note 6	D ₁ Min. See note 5	F	P ₁	R Min. See note 2	T ₂	W	A ₀ B ₀ K ₀
8mm	.179 (4.55)	.039 (1.0)	.138 ± .002 (3.5 ± 0.05)	.157 ± .004 (4.0 ± 0.10)	.984 (25)	.098 (2.5 Max.)	.315 ± .012 (8.0 ± 0.3) Min. Max.	See note 1
12mm	.323 (8.2)	.059 (1.5)	.217 ± .002 (5.5 ± 0.05)	.157 ± .004 (4.0 ± 0.10)	1.181 (30)	.256 (6.5 Max.)	.472 ± .012 (12.0 ± .30)	See note 1

Notes:

- A₀, B₀ and K₀ are determined by the max. dimensions to the ends of the terminals extending from the components body and/or the body of the component. The clearance between the end of the terminals of the body of the components to the sides and depth of the cavity (A₀, B₀ and K₀) must be within .002" (0.05)mm min. and .020" (0.50)mm max. The clearance allowed must also prevent rotation of the component within the cavity of not more than 20 degrees (see examples A & B).
- Tape with components shall pass around radius "R" without damage. The minimum trailer length (Note 2 Fig. 3) may require additional length to provide R min. for .472" (12)mm embossed tape for reels with hub diameters approaching N min. (Table 4).
- G₁ dimension is the flat area from the edge of the sprocket hole to either the outward deformation of the carrier tape between the embossed cavities or to the edge of the cavity whichever is less.
- G₂ dimension is the flat area from the edge of the carrier tape opposite the sprocket holes to either the outward deformation of the carrier tape between the embossed cavity or to the edge of the cavity whichever is less.
- The embossed hole location shall be measured from the sprocket hole controlling the location of the embossment. Dimensions of embossment location and hole location shall be applied independent of each other.
- B₁ dimension is a reference dimension for tape feeder clearance only.

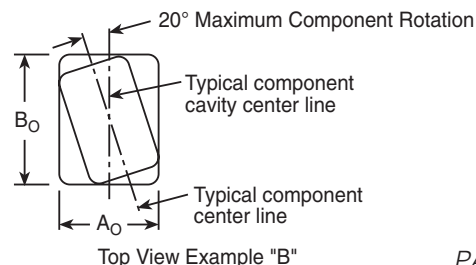
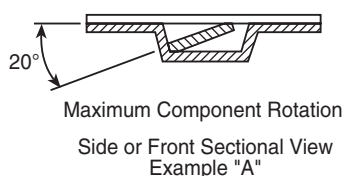

18. Carrier Tape Specifications

Punched paper tape
8 & 12mm

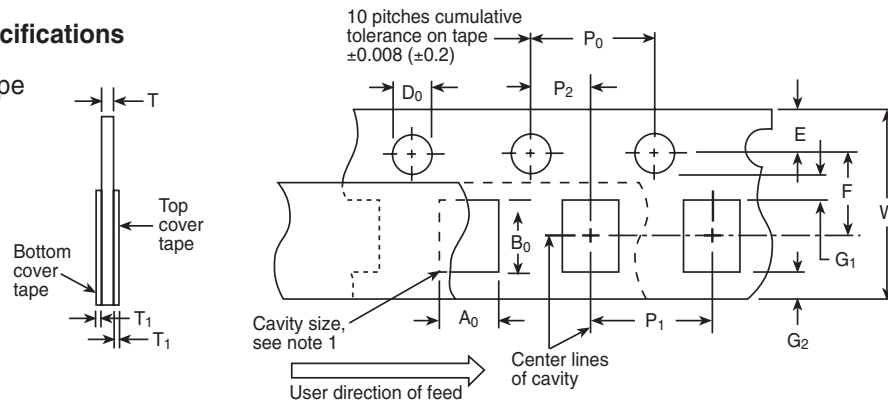

19. Dimensions

Dimensions in inches (mm)

Tape Size <i>Constant</i>	D ₀	E	P ₀	P ₂	T ₁	G ₁	G ₂	R MIN
8mm and 12mm	.059 ± .004 - .000 (1.5 ± 0.1)	.069 ± .004 (1.75 ± 0.10)	.157 ± .004 (4.0 ± 0.10)	.079 ± .002 (2.0 ± 0.05)	.004 (0.10) Max.	.030 (0.75) Min.	.030 (0.75) Min.	.984 (25) See note 2
Tape Size <i>Variable</i>	P ₁		F		W		A ₀ B ₀	T
8mm	.157 ± .004 (4.0 ± 0.10)		.138 ± .002 (3.5 ± 0.05)		.315 ± .012 - .004 (8.0 ± 0.3) - 0.1		See note 1	See note 2
12mm	.157 ± .004 (4.0 ± .010)		.217 ± .002 (5.5 ± 0.05)		.472 ± .012 (12.0 ± 0.3)			

Notes:

- A₀, B₀ and T are determined by the max. dimensions to the ends of the terminals extending from the component body and/or the body dimensions of the component. The clearance between the ends of the terminals or body of the components to the sides and depth of the cavity (A₀, B₀ and T) must be within .002" (0.05) mm min. and .020" (0.50) mm max. The clearance allowed must also prevent rotation of the component within the cavity of not more than 20 degrees (see examples C & D).
- Tape with components shall pass around radius "R" without damage.
- .043" (1.1) mm base tape and .063" (1.6) mm max. for non-paper base compositions.

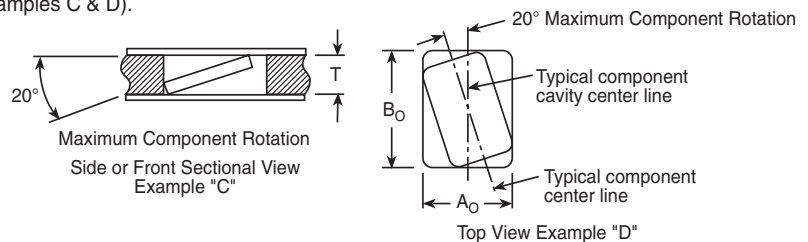

20. Recommended Land Pattern Dimensions

Component pads should be designed to achieve good solder fillets and minimize component movement during reflow soldering. Pad dimensions are given below for multilayer ceramic capacitors for both reflow and wave soldering. The basis for these designs is:

- Pad width equal to component width. It is permissible to decrease this to as low as 85% of component width but it is not advisable to go below this.
- Pad overlap 0.5mm beneath component
- Pad extension 0.5mm beyond components for reflow and 1.0mm for wave soldering

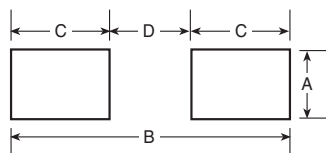

22-1 Reflow Soldering

Case Size	A*	B*	C*	D*
0402	0.50	1.70	0.60	0.50
0603	0.75	2.30	0.80	0.70
0805	1.25	3.00	1.00	1.00
1206	1.60	4.00	1.00	2.00
1210	2.50	4.00	1.00	2.00

22-2 Wave Soldering

Case Size	A*	B*	C*	D*
0805	1.25	4.00	1.50	1.00
1206	1.60	5.00	1.50	2.00
1210	2.50	5.00	1.50	2.00

* All dimensions are in millimeters unless otherwise specified.